

OPER

TOOLS

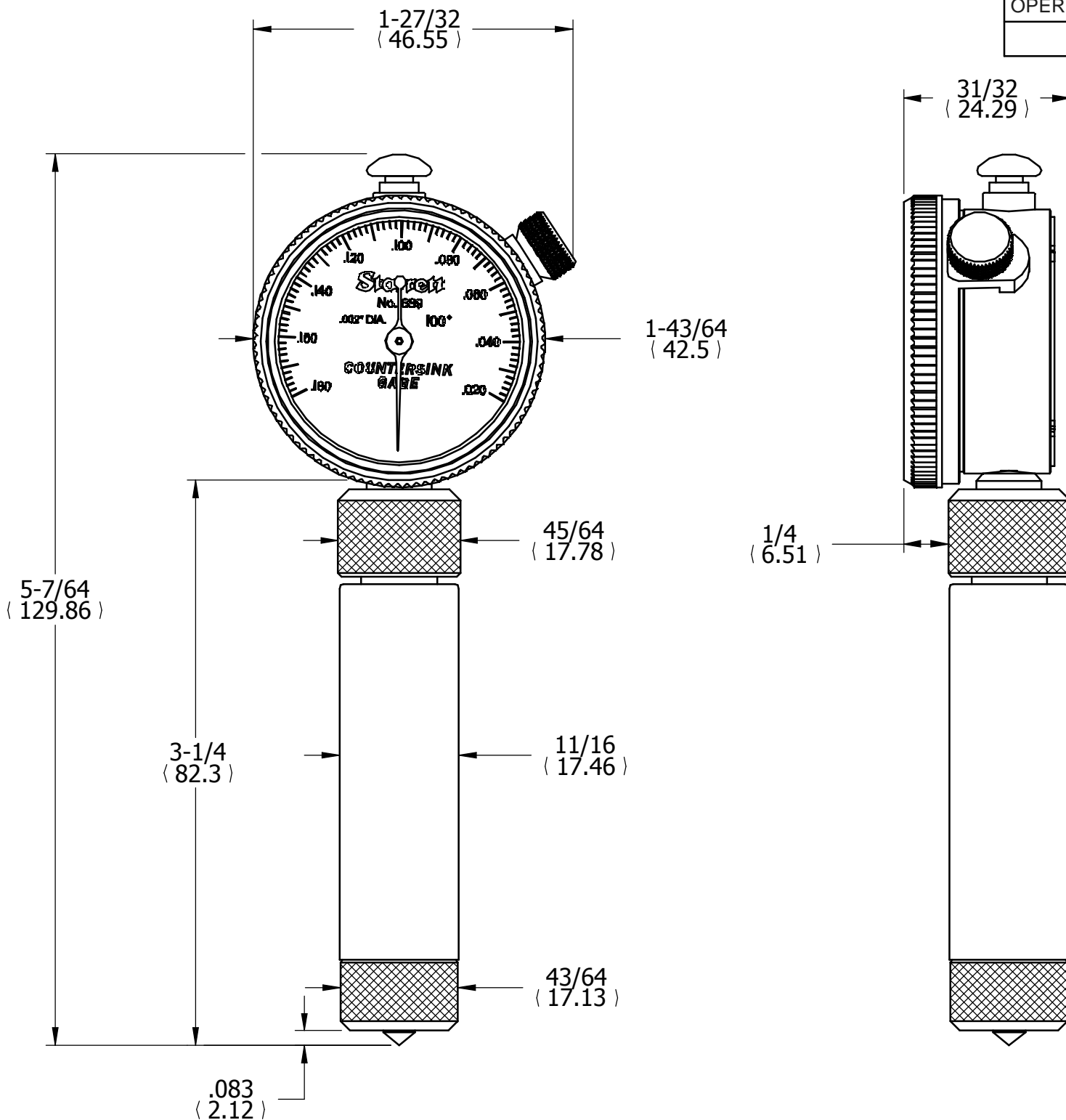

REV	DESCRIPTION	DATE	BY
DR	K.P.H.	CHK	DATE

**.020 - .170 RANGE
100° ANGLE
COUNTERSINK GAGE**

**THE L.S. STARRETT CO.
ATHOL, MASS.**

FRACTIONAL TOLERANCE +- 1/64 UNLESS OTHERWISE NOTED