

OPER

TOOLS

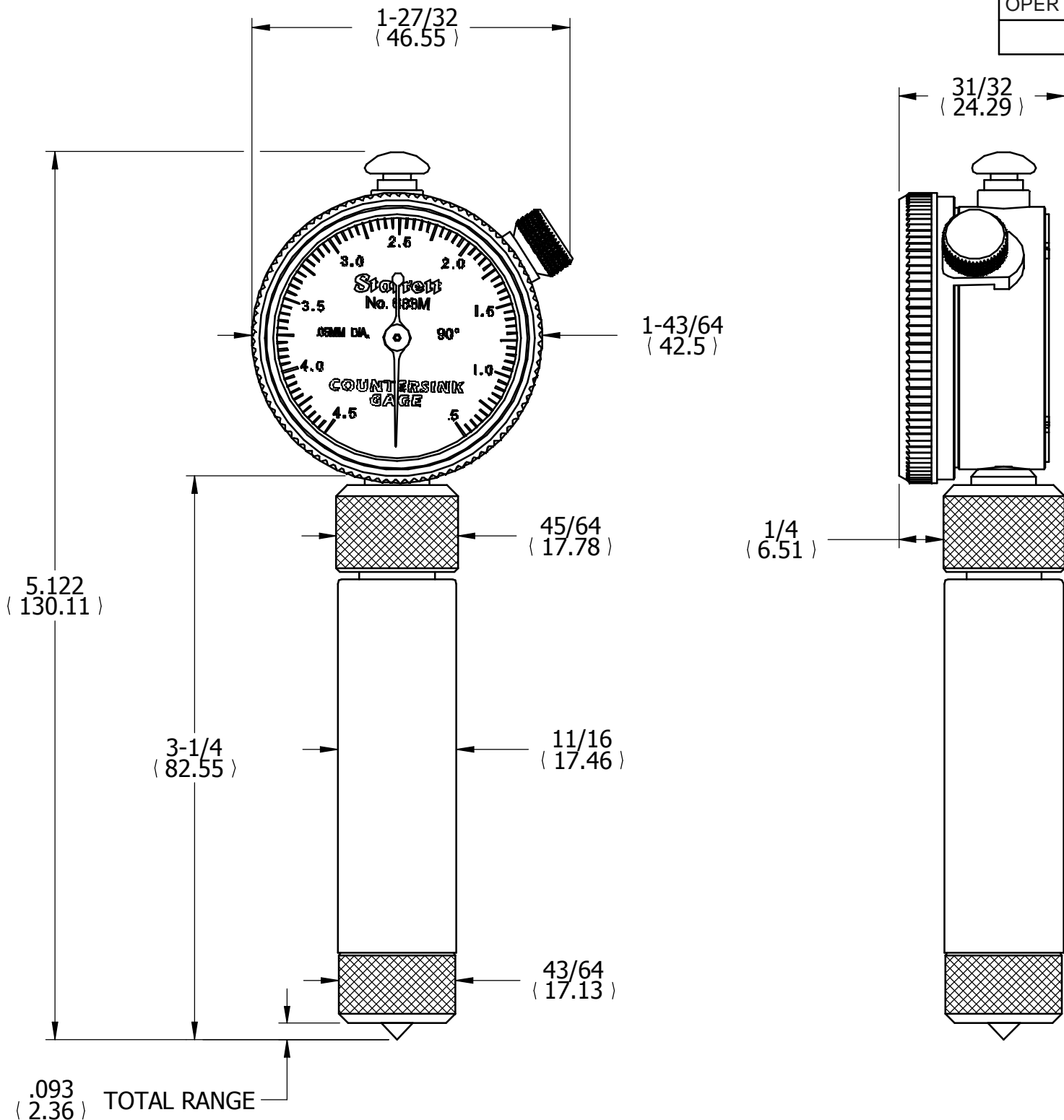

REV	DESCRIPTION	DATE	BY
DR	K.P.H.	CHK	DATE

0.5-4. 3MM RANGE
90° ANGLE
COUNTERSINK GAGE

THE L.S. STARRETT CO.
ATHOL, MASS.

FRACTIONAL TOLERANCE +- 1/64 UNLESS OTHERWISE NOTED