

Hard part turning with CBN



Choose the right solution

Since it was first introduced as a cutting tool material in the 1980s, the use of cubic boron nitride (CBN) has evolved to become a common machining solution. The application areas include hardened steels, cast irons, heat resistant super alloys (HRSA) and powdered metals. These workpiece materials have one thing in common; they are generally recognised as being difficult to machine.

A CBN insert can withstand the high cutting temperatures and forces and still retain its cutting edge. This is why CBN delivers long, consistent tool life and produces components with excellent surface finish.

Sandvik Coromant offers a comprehensive program of unique CBN products for finish turning of case hardened steels. In this brochure you will find the correct grade, geometry and edge preparation for your application. Whatever your component design or surface finish requirements we will deliver high productivity and outstanding quality.



Did you know...

...that CBN is the second hardest known material in the world; the hardest being diamond. This, in addition to many other extreme properties makes it the ideal cutting tool material for hard, abrasive workpieces. CBN has greater chemical and thermal stability than diamond, which dissolves in iron and has a maximum temperature limit of approximately 700°C (1300°F).

In contrast, CBN is chemically inert in ferrous materials and retains its hardness at temperatures in excess of 1000°C (1800°F) which is typical for HPT.

Contents

- Choose the right solution.....2
- Choose the right geometry.....6
- Choose the right edge preparation8
- CoroTurn® TR.....10
- Edge preparation guide11
- Additional insert families14
- Prepare for success15
- Tool wear18
- Hard part turning - assortment.....20

Choose the right grade

Each CBN grade in our hard part turning range has been specifically designed for high performance in finish turning of case hardened steels.

- CB7015 - for continuous to light interrupted cutting
- CB7025 - for light to medium interrupted cutting
- CB7525 - for heavy interrupted cutting

In order to select the most suitable grade, you must determine what type of cutting best describes your application. In the following pages we guide you through our CBN product range to find the best solution for your process.

What is hard part turning?

Using a very broad definition hard part turning refers to hardened steels at 55 HRC and above. There are many different types of steel (carbon steels, alloy steels, tool steels, bearing steels etc.) that can achieve these high levels of hardness. The common hardening methods are case hardening, induction hardening and through hardening. Hard part turning is usually a finishing or semi-finishing process with high dimensional accuracy and surface quality requirements.

Application areas

The illustration below helps you find the right grade for your application and relates to grade toughness and cutting speed capability.

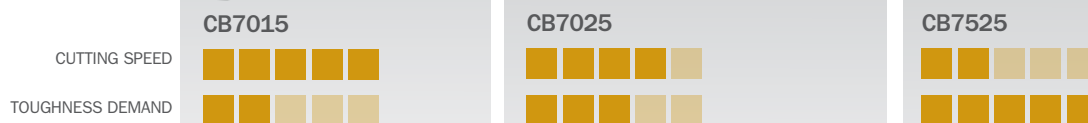

CB7015

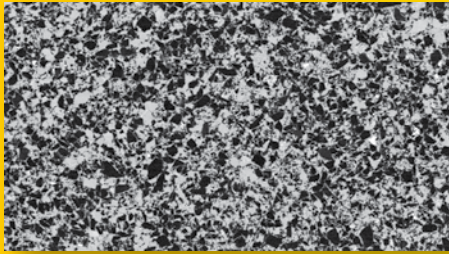

CB7015 contains 50% CBN with fine grain size in a unique ceramic binder. Maximum performance is achieved in continuous to light interrupted cutting where machine conditions are very stable. CB7015 is coated for easy wear detection.

Cutting data recommendations

Cutting speed, v_c m/min (ft/min)	50 (164)	100 (328)	150 (492)	200 (656)	250 (820)
Feed, f_n m/r (inch/r)	0.1 (0.0039)	0.2 (0.0079)	0.3 (0.0118)	0.4 (0.0157)	0.5 (0.0197)
Depth of cut, AP mm (inch)	0.1 (0.0039)	0.2 (0.0079)	0.3 (0.0118)	0.4 (0.0157)	0.5 (0.0197)

■ = Recommended starting value

CB7025

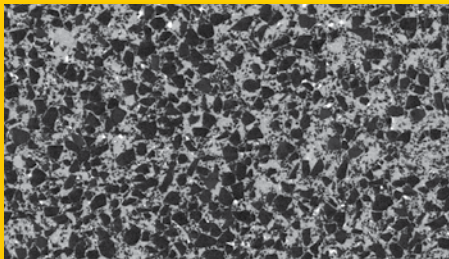

CB7025 is a unique, patented material (US 7670 980 B2) containing 60% CBN with a bimodal grain distribution (1&3 μm) in a ceramic binder. High fracture resistance makes it a very versatile grade for hard part turning. It has excellent tool life in interrupted cutting and is also recommended for mixed production and when there is some instability in machine setup.

Cutting data recommendations

Cutting speed, v_c m/min (ft/min)	50 (164)	100 (328)	150 (492)	200 (656)	250 (820)
Feed, f_n m/r (inch/r)	0.1 (0.0039)	0.2 (0.0079)	0.3 (0.0118)	0.4 (0.0157)	0.5 (0.0197)
Depth of cut, AP mm (inch)	0.1 (0.0039)	0.2 (0.0079)	0.3 (0.0118)	0.4 (0.0157)	0.5 (0.0197)

■ = Recommended starting value

CB7525

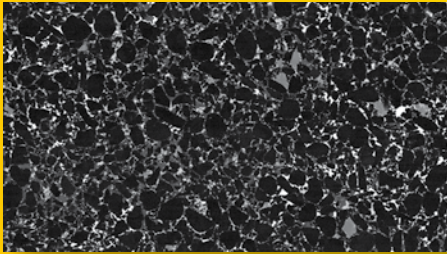

CB7525 is a very tough grade and contains 90% CBN with fine grains in a ceramic binder. It is designed for grey cast iron machining and also performs well in hard part turning applications in heavy interrupted cuts (short contact time) as well as in very abrasive steels (tool steels, manganese steels).

Cutting data recommendations

Cutting speed, v_c m/min (ft/min)	50 (164)	100 (328)	150 (492)	200 (656)	250 (820)
Feed, f_n m/r (inch/r)	0.1 (0.0039)	0.2 (0.0079)	0.3 (0.0118)	0.4 (0.0157)	0.5 (0.0197)
Depth of cut, AP mm (inch)	0.1 (0.0039)	0.2 (0.0079)	0.3 (0.0118)	0.4 (0.0157)	0.5 (0.0197)

■ = Recommended starting value

CB7925

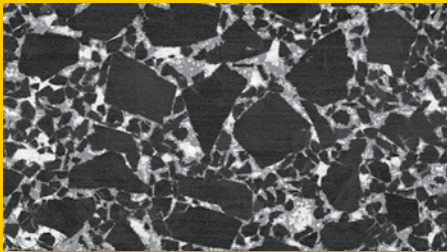

CB7925 contains 75% CBN in a ceramic binder. It has a bimodal CBN grain size distribution with a mix of large and fine CBN grains (4 & 12 μm). The main application area is high alloy cast irons but this grade will also perform well in turning of hardened steel and cast iron rolls. CB7925 CBN inserts are only available in solid format.

Cutting data recommendations

Cutting speed, v_c m/min (ft/min)	50 (164)	100 (328)	150 (492)	200 (656)	250 (820)
Feed, f_n m/r (inch/r)	0.1 (0.0039)	0.2 (0.0079)	0.3 (0.0118)	0.4 (0.0157)	0.5 (0.0197)
Depth of cut, AP mm (inch)	0.1 (0.0039)	0.2 (0.0079)	0.3 (0.0118)	0.4 (0.0157)	0.5 (0.0197)

■ = Recommended starting value



Choose the right geometry

The insert geometry and edge preparation are extremely important in hard part turning as they have a significant influence on tool life and productivity. The Sandvik Coromant CBN product range includes inserts with standard nose radius, wipers and the unique Xcel design. The standard nose radius generates the lowest cutting forces and has the lowest stability requirements while wipers and Xcel give an unbeatable combination of high productivity and excellent surface finish.

Standard nose radius

Insert nose radius is an important performance parameter:

- A small nose radius: 02, 04 mm (0.008-0.016 inch) provides good chip breaking.
- A large nose radius: 08, 12 mm (0.03-0.05 inch) generates better surface finish and produces thinner chips, which reduces the degree of crater wear in hard part turning operations.
- The combination of a large nose radius with small depth of cut results in reduced entry and exit forces.

In general, a large nose radius provides greater edge strength and therefore extended tool life. Use the largest nose radius allowed based on your process requirements.

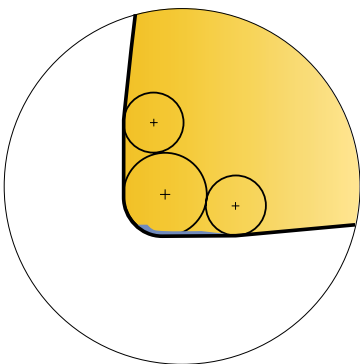

Wiper

The Sandvik Coromant patented wiper designs -WH and -WG are based on a number of blended radii and have been developed specifically for HPT.

Wiper inserts provide two possibilities for process improvement:

- Improved surface finish with standard cutting data.
- Maintained surface finish at substantially higher feed rate.

Xcel

The Xcel geometry has a straight cutting edge with a low entry angle. This produces thin chips and lower cutting temperatures, leading to reduced crater wear development. The benefits of Xcel are maximised when the entire cutting edge is used, so optimum performance is achieved on straight surfaces for one pass finishing at feed rate of 0.3 to 0.5 mm/r (0.012 to 0.02 inch/r). The maximum depth of cut is 0.25mm (.01 inch). It is possible to use eight cutting edges on an Xcel insert.



Why Hard Part Turning?

In the past, grinding was the common finishing process for hardened steel components. Today hard part turning is widely regarded as an efficient and cost effective alternative. Hard part turning can significantly boost productivity and at the same time deliver environmental benefits.

- High quality
- Reduced production time per component
- Process flexibility
- Lower machine investment costs
- Reduced energy requirements
- Coolant not required
- Easier swarf handling
- Possibility to recycle chips

Insert geometries

The measured surface qualities below give an indication of what geometry to choose under specific conditions.



Hardness = 58-62 HRC

AP = 0,15 mm
(0.0059 inch)

$v_c = 160$ m/min
(525 ft/min)

1. Radius

$f_n = 0.1$ mm/r
(0.0039 inch/r)
 $r = 0.8$ mm/
(0.0315 inch)

Ra 0.433 μ m in 0.000017
Rz 1.72 μ m in 0.000068



Standard geometry

- Lowest requirements on stability
- Lowest cutting forces
- Normal surface finish vs. feed

2. Wiper

$f_n = 0.2$ mm/r
(0.0079 inch/r)
 $r = 0.8 + WH$
(0.0315 inch + WH)

Ra 0.391 μ m in 0.000015
Rz 1.67 μ m in 0.000066



WH geometry

- Versatile first choice
- Low cutting forces
- Low requirements on stability
- Improved surface finish vs. feed

3. Xcel™

$f_n = 0.5$ mm/r
(0.0197 inch/r)

Ra 0.935 μ m in 0.000037
Rz 4.60 μ m in 0.000181



Xcel

- Very high stability requirements
- Good surface finish at high feed rate

Choose the right edge preparation

The combination of the nose radius and the edge preparation has a significant influence on tool life, surface finish and integrity of the machined part. It is very important to select the chamfer size and edge condition best suited to your application.

Edge condition

There are three edge conditions available in the Sandvik Coromant CBN range:

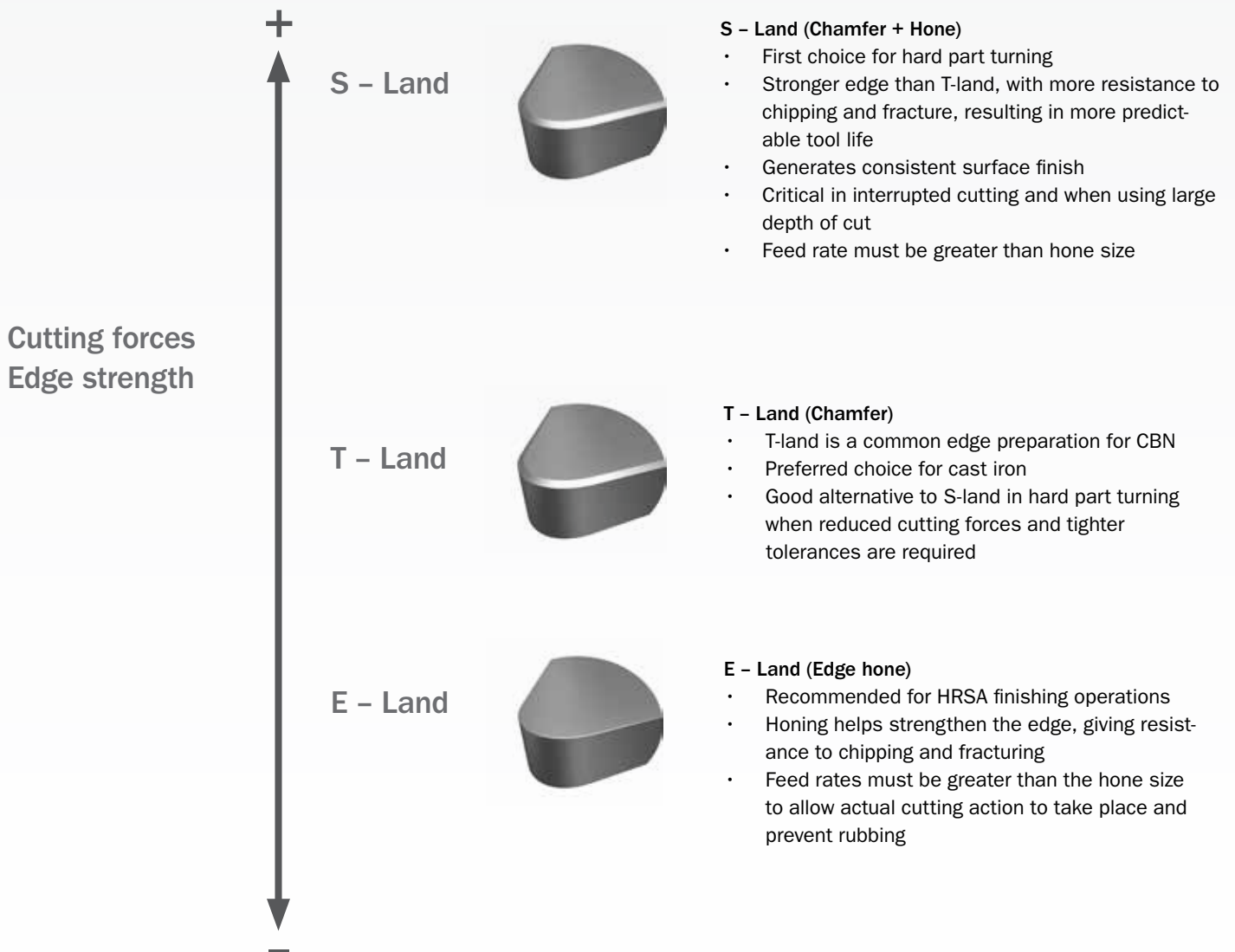

Safe-Lok

The Safe-Lok tip on our negative inserts is a unique Sandvik Coromant concept. It provides a mechanical interlock in addition to brazing which gives additional strength and security in aggressive cutting conditions.

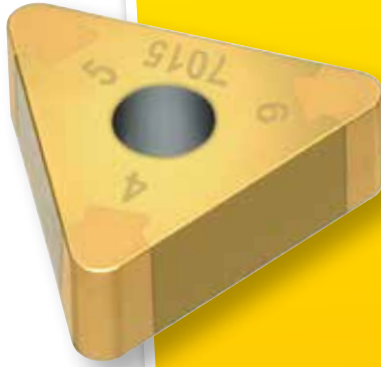

Chamfer angle and width

In general, the strength of the cutting edge on CBN inserts increases with increasing chamfer angle and width, but also results in increased cutting forces and temperature.

A wide chamfer spreads the cutting forces over a larger area, which provides a more robust cutting edge, allowing for higher feed rates. Where process stability and consistent tool life are the most important factors, the best solution will be obtained using a large chamfer.

If surface finish and dimensional accuracy are the main requirements, a small chamfer will provide the best results. Cutting forces and temperature will be reduced and there will be less vibration. In some cases, where surface finish is critical, a honed edge (E-land) can be beneficial, even though the tool life will be shorter.

Since hard part turning is usually employed as a finishing operation, it is necessary to find the optimum edge design which produces high quality components and a stable production process with good tool life.

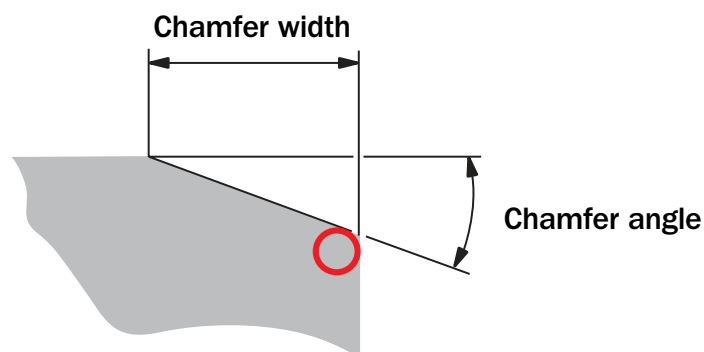

Chamfer angle

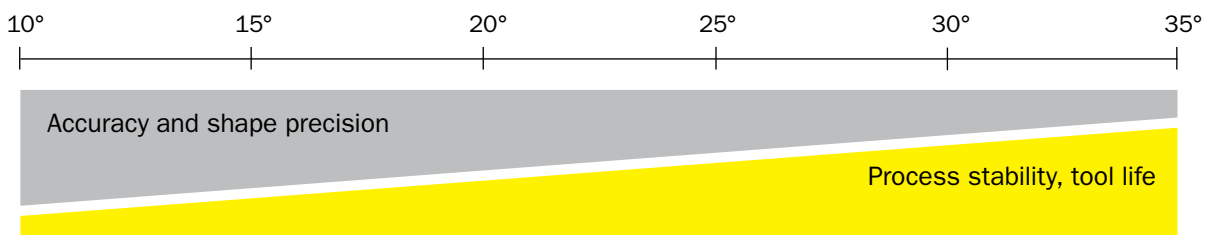

CoroTurn® TR

CoroTurn® TR provides a unique solution for high precision profiling of hardened steel components. The iLock interface ensures extremely secure and stable positioning of the insert in the seat. In this way, CoroTurn® TR eliminates micro-movement of the insert which can occur during profiling operations where the insert is subjected to multi-directional cutting forces when the tool path changes. CoroTurn® TR is available in CBN grades CB7015 and CB7025.

- Maximum insert stability in the tool holder
- Repeatable insert indexing
- Closer tolerances and high quality surfaces
- Long, predictable tool life

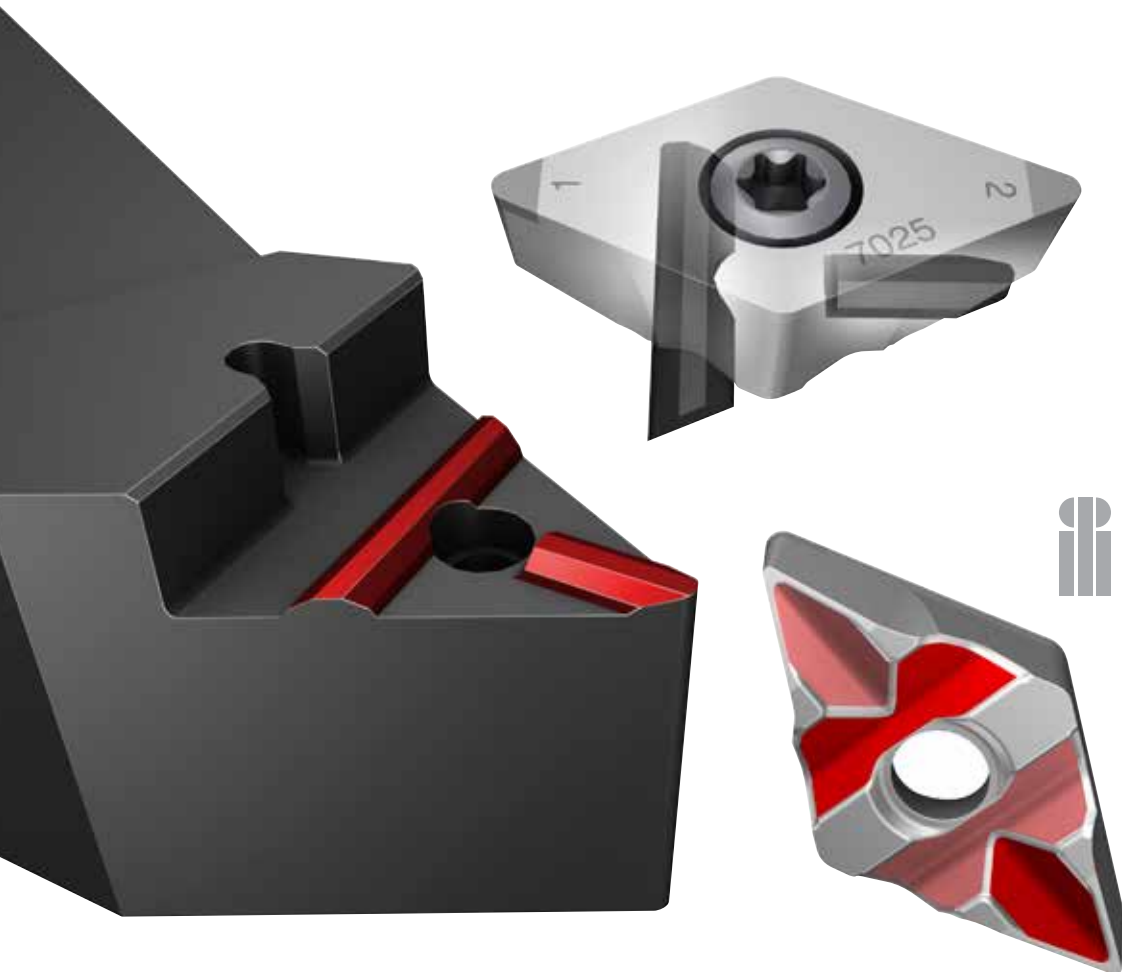

Edge preparation guide

Edge Geometry Selection CB7015

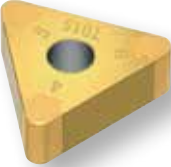
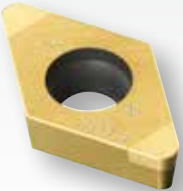
CB7015	Continuous	Medium interrupt	Heavy interrupt
<p>Negative</p> 	<p>E</p> <p>T01030</p> <p>S01030</p> <p>S02035</p>	<p><i>First choice</i></p>	
<p>Positive</p> 	<p>T01020</p> <p>S01020</p> <p>T01030</p> <p>S01030</p> <p>S01530</p>	<p><i>First choice</i></p>	

S01030 - First choice.

T01030 - Use to decrease vibration and cutting forces with standard radius. First choice for WH wiper.

S02035 - Strong cutting edge for interrupted cutting and unstable machine setups.

E - For finishing operations on HRSA materials.

Can be used in HPT continuous cutting where very low cutting forces are required.

S01020 - First choice.

T01020 - Use to decrease vibration and cutting forces.

S01030 - A strong cutting edge for small inserts.

T01030 - A strong cutting edge for small inserts.

Use to decrease vibration and cutting forces.

S01530 - A very strong cutting edge for interrupted cutting and unstable setups using larger inserts.

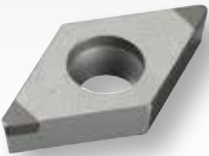

Edge Geometry Selection CB7025

CB7025	Continuous	Medium interrupt	Heavy interrupt
Negative 		S01020 <i>First choice</i> S01030 S02035	
Positive 		S01020 <i>First choice</i> T01030 S01030 S01530	

S01030 - First choice.

S01020 - Use when lower cutting forces are required.

S02035 - Strong cutting edge for interrupted cutting and unstable machine setups.

S01020 - First choice.

S01030 - A stronger cutting edge.

T01030 - A stronger cutting edge. Use to decrease vibration and cutting forces.

S01530 - A very strong cutting edge for interrupted cutting and unstable machine setups.

Tailor Made

Even more edge geometry options are available through our Tailor Made program.

Edge Geometry Selection CB7525 (for ISO-H materials)

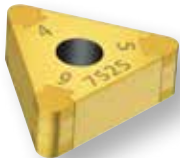
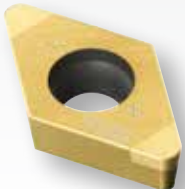
CB7525	Continuous	Medium interrupt	Heavy interrupt
<p>Negative</p> 			<p>T01020</p> <p>S01530</p> <p>S02035</p>
<p>Positive</p> 			<p>T01020</p> <p>S01030</p> <p>S01530</p>

First choice

First choice

S02035 - First choice.
 S01530 - A strong edge when lower cutting forces are required.
 T01020 - Use for lowest cutting forces and to decrease vibration. First choice for cast iron.

S01030 - First choice.
 S01530 - A stronger cutting edge.
 T01020 - Use to reduce cutting forces and decrease vibration. First choice for cast iron.

CBN in other insert families

In addition to the general turning assortment our CBN range also includes inserts for parting and grooving, threading and small part machining available.

CoroCut® 1-2 System

CoroCut 1-2 is your first choice for parting, profiling and grooving. The system is based on a patented rail and V-shaped design which together with a long insert gives exceptional stability. This combination makes it possible to run at high cutting data and still achieve better productivity and close tolerances than any other system on the market. Use CoroCut inserts with -GE geometry for grooving and -RE for profiling. Insert widths available from 2.5 to 8.0 mm (0.1-0.3 inch) in grades CB7015 and CB20.

CoroThread® 266

CoroThread® 266 delivers high precision threading performance. The unique iLock interface between the insert and the tip seat eliminates insert movement caused by cutting force vibration. Available in grade CB7015.

CoroTurn® XS

Precision inserts in small sizes, down to 7.0 mm (0.23 inch) for threading operations and 6.2 mm (0.24 inch) for grooving and threading. Its unique clamping system makes it reliable and easy to use. All CoroTurn XS grooving inserts produce grooves with flat bottom and sharp corner radii. Available in grade CB7015.

CoroCut® MB

CoroCut MB is a high-precision grooving, turning, and threading system for hole diameters from 10 mm (0.394 inch) and more. The edge line of the insert is sharp, and together with a thin-layered coating, it is suitable for internal machining. Available in grade CB7015.

Success with CoroCut®

- Cutting data start values
- speed: 120m/min (390 ft/min)
- feed: 0.04mm/r (.0016 inch/r)
- Use coolant for long cutting times
- Use short tool overhang
- Use largest possible insert seat size



Prepare for success

Component design and preparation

Careful preparation of the component in the soft (unhardened) state will benefit the hard part turning process. Due to the relatively small depths of cut used in hard part turning, tight dimensional tolerances in soft machining are key to achieving a consistent process. This delivers longer tool life and high quality components. The use of features such as chamfers and radii on the component will optimise entry and exit paths for maximum tool life.

Points to remember when planning your soft machining conditions include:

- Avoid burrs
- Keep close dimensional tolerances
- Chamfer and make radii in the soft state
- Do not enter or leave cut abruptly
- Enter or leave by programming radius movements

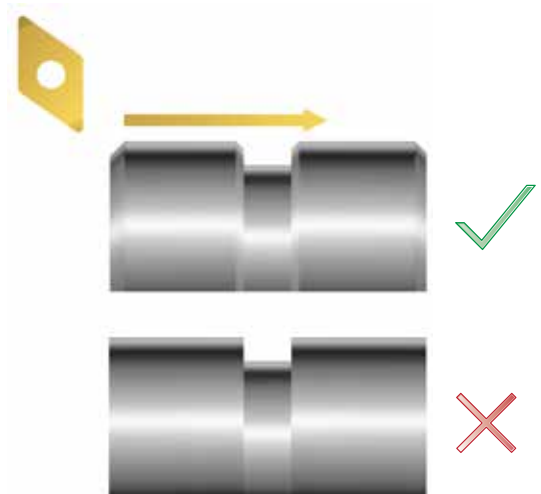

Component Clamping

Wide clamping jaws offer many benefits compared to ordinary three point jaws. This is particularly true for thin walled components which require extremely secure clamping.

The component should be as close as possible to the spindle bearings. As a general guideline, a length-to-diameter ratio of 2:1 is recommended for work-pieces supported on one end only, with acceptable maximum of 4:1. Where there is additional tailstock support, the ratio can be extended to 8:1. Correct alignment of the headstock and tailstock also adds to the rigidity of the setup.

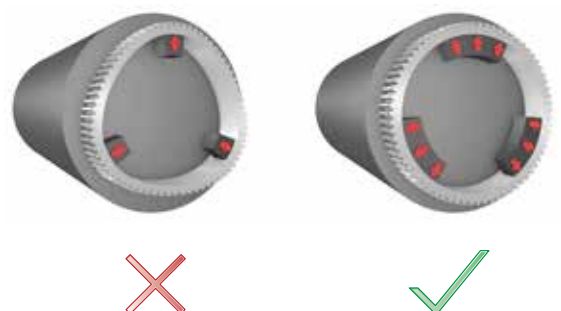

Toolholder and insert clamping

Use Coromant Capto for maximum stability. Alternatively, carbide bars are preferred to steel bars, because of their inherent stiffness. Use a rigid tool with a large cross-section and keep the overhang as short as possible. The security and stability provided by the CoroTurn® RC clamping system is recommended for CBN inserts.

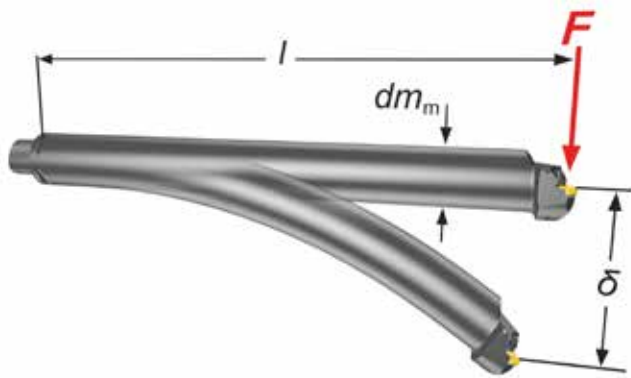

Wet or dry machining

Dry cutting is one of the key advantages of hard part turning. CBN inserts can tolerate cutting temperatures in excess of 1,000°C (1800°F). In general, the use of CBN in dry conditions has a positive effect on tool life, particularly in interrupted cutting.

Elimination of coolant:

- Reduces costs
- Leads to easier chip handling
- Is more environmentally friendly

However, there are some situations where coolant is required:

- To facilitate chip breaking
- To control the thermal stability of the workpiece
- To remove heat when machining big components

The coolant must always be applied as a consistent flow over the entire cutting length.

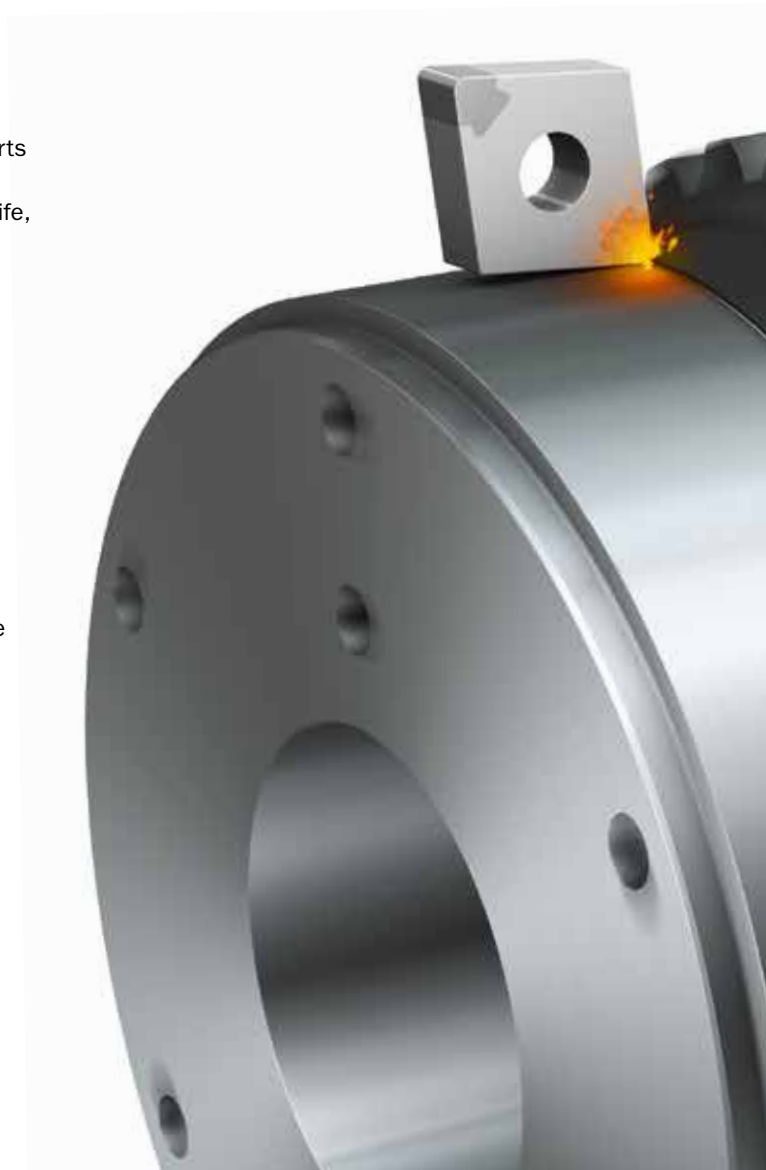

One or two cut strategy

When deciding between a one- or a two cut strategy, these factors must be considered:

- Machine capability
- What the most important process measures are.

It is very often a balance between accuracy and productivity.

One-cut strategy

With a high quality machine tool and a stable setup, a single cut can produce acceptable levels of surface quality and dimensional tolerance.

Two-cut strategy

When the machine setup is unstable, if there is any inconsistency in the component or if a very high final tolerance or surface quality is required, a two-cut strategy is likely to be the best option.

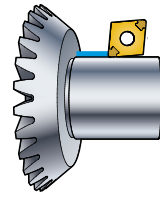

One-cut strategy

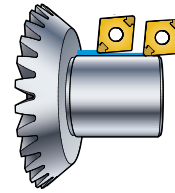

Two-cut strategy



Tool wear

In hard part turning the most common forms of CBN tool wear are crater and flank wear. The wear process depends on a number of factors:

- Workpiece material
- CBN grade
- Cutting conditions
- Edge geometry
- Machine stability.



Crater wear

Crater wear is dominant when machining case hardened steels and is mainly caused by chemical wear, due to the extremely high temperature and the forces at the contact point between the workpiece and the CBN insert. Crater wear development weakens the cutting edge which can lead to inconsistent tool life.

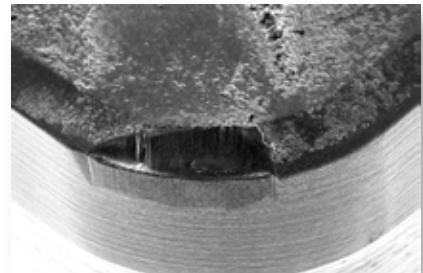



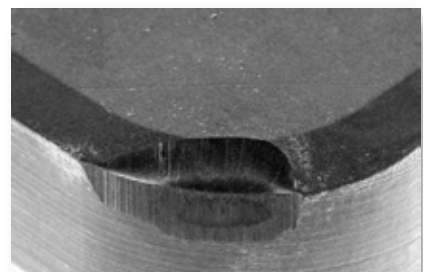

Flank wear

Flank wear is more common at lower cutting speeds and when machining more abrasive steels such as bearing or tool steels. The primary wear mechanism is abrasion. Large flank wear has a negative effect on surface integrity and dimensional accuracy.

Even though wear is complex, there are ways to control it and maintain a consistent and reliable machining operation.



Troubleshooting recommendations

Tool wear	Solution
<p>Flank wear</p> 	<ul style="list-style-type: none"> • Increase cutting speed. • Increase feed.
<p>Crater wear</p> 	<ul style="list-style-type: none"> • Reduce cutting speed. • Increase feed.
<p>Chipping</p> 	<ul style="list-style-type: none"> • Check stability, eliminate vibration. • Do not use coolant. • Use a stronger cutting edge; <ul style="list-style-type: none"> - S-edge geometry - Increase chamfer size (angle and /or width) - Use larger nose radius.
<p>Cracking /fracture</p> 	<ul style="list-style-type: none"> • Use uncoated inserts. • Check stability, eliminate vibration. • Check/ replace shim. • Make sure tool is aligned to centre. • Do not use coolant. • Decrease feed. • Decrease depth of cut. • Use a stronger cutting edge; <ul style="list-style-type: none"> - S-edge geometry - Increase chamfer size (angle and /or width) - Use larger nose radius. - Use wiper.
<p>Notch wear</p> 	<ul style="list-style-type: none"> • Increase speed. • Reduce feed. • Reduce/ vary depth of cut.

Code key

Metric

C	N	G	A	12	04	08	T	010	20	R	A	WG
1	2	3	4	5	6	7	8	9	10	11	12	13

Inch

C	N	G	A	4	3	2	T	03	20	R	A	WG
1	2	3	4	5	6	7	8	9	10	11	12	13

1 Insert shape

C		D	
K		R	
S		T	
V		W	

2 Insert clearance angle

B		C	
E		N	
P		O	Specific description

4 Insert type

A		Q	
G		R	
M		T	
N		W	
P		X	 Special design

3 Tolerances, metric

Class	S	IC / W1	
G	±0.13	±0.025	
M	±0.13	±0.05 – ±0.15 ¹⁾	
U	±0.13	±0.08 – ±0.25 ¹⁾	
E	±0.025	±0.025	

¹⁾Varies depending on the size of IC. See below.

Inscribed circle IC mm	Tolerance class	
	M	U
3.97		
5.0		
5.56		
6.0	±0.05	±0.08
6.35		
8.0		
9.525		
10.0		
12.0	±0.08	±0.13
12.7		
15.875		
16.0	±0.10	±0.18
19.05		
20.0		
25.0	±0.13	±0.25
25.4		
31.75	±0.15	±0.25
32.0		

For positive inserts IC is valid for a sharp corner. See cutting edge condition F. (Picture 8).

3 Tolerances, inch

Class	B:	A:	T:
A	±.0002	±.001	±.001
B	.0002	.001	.005
C	.0005	.001	.001
D	.0005	.001	.005
E	.001	.001	.001
F	.0002	.0005	.001
G	.001	.001	.005
H	.0005	.0005	.001
J	.0002	.002-.005	.001
K	.0005	.002-.005	.001
L	.001	.002-.005	.001
M	.002-.005	.002-.005	.005
U	.005-.012	.005-.010	.005
N	.002-.010	.002-.004	.001

A: Theoretical diameter of the insert inscribed circle.
T: Thickness of the insert.
B: See figures.

5 Insert size

Inscribed circle, inch	Cutting edge length, metric	Cutting edge length, inch							
		C	D	R	S	T	V	W	K
IC mm	IC inch								
3.18	1/8"								
3.97	5/32"								
5.0				05					
6.0				06					
6.35	1/4"	06	07						
8.0				08					
9.525	3/8"	09	11	09	16	16	06	16 ¹⁾	
10.0				10					
12.0				12					
12.7	1/2"	12	15	12	22	22	08		
15.875	5/8"	16		15	27				
16.0				16					
19.0	3/4"	19		19	33				
20.0				20					
25.0				25 ¹⁾					
25.4	1"			25 ²⁾	25				
31.75	1 1/4"	25		31					
32				32					

¹⁾ For insert shape K (KNMX, KNUX) only the theoretical cutting edge length is indicated.
²⁾ Inch base design

6 Insert thickness, S mm, inch			
Metric			Inch
01 S = 1.59	1.	S = .0625	
T1 S = 1.98	(1.2)	S = .075	
02 S = 2.38	(1.5)	S = 3/32	
03 S = 3.18	2	S = 1/8	
T3 S = 3.97	(2.5)	S = 5/32	
04 S = 4.76	3	S = 3/16	
05 S = 5.56	4	S = 1/4	
06 S = 6.35	5	S = 5/16	
07 S = 7.94	6	S = 3/8	
09 S = 9.52	6.3	S = .394	
10 S = 10.00	7.6	S = .475	
12 S = 12.00			

7 Nose radius, RE mm, inch		
Metric:	Inch:	Actual dimension:
00 = 0	00	Round
01 = 0.1	03	.004
02 = 0.2	0	.008
04 = 0.4	1 = 1/64	.0156
05 = 0.5		
08 = 0.8	2 = 1/32	.0312
10 = 1.0		
12 = 1.2	3 = 3/64	.047
15 = 1.5		
16 = 1.6	4 = 1/16	.0625
24 = 2.4	6 = 3/32	.094
32 = 3.2	8 = 1/8	.125
Note: See example for approximation of metric nose radius. 16=1.6mm=.063≈.0625 inch		

8 Cutting edge condition		
F		Sharp cutting edge
E (A)		ER treated cutting edge
		A (inch) E (metric)
T		Negative land
K		Double negative lands
S		Negative land and ER treated cutting edge

12 Insert Type (CBN)	
To allow a variety of machining demands to be met, several types of inserts comprising CBN and PCD is manufactured. To easy identify the different types Sandvik Coromant uses a letter to denote the variants.	
A	CBN, Multi Corner Inserts - Fully indexable - CBN top to bottom of the carbide carrier corners
B	CBN, Multi Corner Inserts - Fully indexable - CBN brazed to the top and bottom of the carbide carrier corners.
E	CBN, Single tip inserts - Non-indexable - CBN brazed to the top of one of the carbide carrier corners
F	CBN, Multi tip inserts - Indexable - CBN brazed to each corner of the carbide carrier
D	CBN, Full top inserts - Indexable - CBN sintered to the complete top surface of the carbide carrier
M	CBN, Solid inserts - Fully indexable - Complete insert made from CBN

9 Chamfer width		
	ISO mm	ANSI inch
	010 BN = 0.10	03 BN = (.003)
	015 BN = 0.15	06 BN = (.006)
	020 BN = 0.20	08 BN = (.0078)
	025 BN = 0.25	08 BN = (.0098)
	070 BN = 0.70	30 BN = (.030)
	150 BN = 1.50	60 BN = (.060)
	200 BN = 2.00	80 BN = (.080)

10 Chamfer angle, degrees		
	15 GB = 15°	30 GB = 30°
	20 GB = 20°	35 GB = 35°
	25 GB = 25°	

11 Hand of insert	
Inserts designed solely for machining in left or right direction are indicated as below.	
R	Right hand design
L	Left hand design

13 Wiper Geometry	
Our unique Wiper and Xcel technologies can be used to boost productivity and generate superior surface finish.	
WG	Wiper geometry for general purpose machining Allows high feed rates in HPT Suitable for finish machining of GCI
WH	Wiper geometry optimized for HPT Low cutting forces for superior surface finish Designed for peak performance at HPT finishing feed rates
Xcel	Allows the use of higher feed rates than other wiper geometries XA Maintains surface finish

Negative basic-shape inserts

T-Max® P

Rhombic 80°

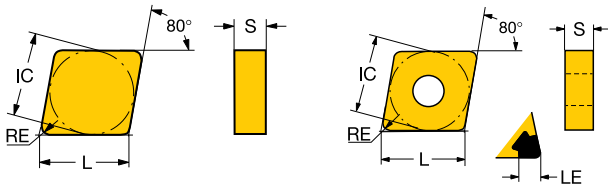

		LE	LE"	ISO CODE	K		H			ANSI CODE			
					7525	7925	7015	7025	7525		CB20		
Finishing		12	1/2	2.6	.102	CNGX1204L025-18AXA			☆	☆		CNGX1204L025-18AXA	
		09	3/8	2.3	.091	CNGA090304S01030AWH				☆			CNGA321S0330AWH
				2.2	.087	CNGA090308S01030AWH				☆			CNGA322S0330AWH
		12	1/2	2.8	.110	CNGA120404S01030AWH				☆			CNGA431S0330AWH
				2.7	.106	CNGA120408S01030AWH			☆	☆			CNGA432S0330AWH
				2.0	.079	CNGA120408S02035AWH			☆	☆			CNGA432S0835AWH
				2.7	.106	CNGA120412S01030AWH				☆			CNGA433S0330AWH
		09	3/8	2.3	.091	CNGA090304T01030AWH			☆				CNGA321T0330AWH
				2.2	.087	CNGA090308T01030AWH			☆				CNGA322T0330AWH
		12	1/2	2.8	.110	CNGA120404T01030AWH			☆				CNGA431T0330AWH
				2.7	.106	CNGA120408T01030AWH			☆				CNGA432T0330AWH
			2.7	.106	CNGA120412T01030AWH			☆				CNGA433T0330AWH	
		12	1/2	2.7	.106	CNGA120408S01030AWG			☆	☆			CNGA432S0330AWG
				2.7	.106	CNGA120412S01030AWG			☆	☆			CNGA433S0330AWG
		12	1/2	2.8	.110	CNGA120404T01020BWG	☆				☆		CNGA431T0320BWG
				2.7	.106	CNGA120408T01020BWG	☆				☆		CNGA432T0320BWG
		09	3/8	2.3	.091	CNGA090304S01030A			☆	☆			CNGA321S0330A
				2.2	.087	CNGA090308S01030A			☆	☆			CNGA322S0330A
				2.0	.079	CNGA090308S02035A				☆			CNGA322S0835A
12		1/2	1.8	.071	CNGA120404S01020A				☆			CNGA431S0320A	
			2.8	.110	CNGA120404S01030A			☆	☆			CNGA431S0330A	
			1.8	.071	CNGA120404S02035A				☆			CNGA431S0835A	
			2.8	.110	CNGA120404S02035B					☆		CNGA431S0835B	
			2.0	.079	CNGA120408S01018A			☆	☆			CNGA432S0318A	
			2.7	.106	CNGA120408S01030A			☆	☆			CNGA432S0330A	
			2.0	.079	CNGA120408S01530B					☆		CNGA432S0630B	
			2.0	.079	CNGA120408S02035A			☆	☆			CNGA432S0835A	
			2.8	.110	CNGA120408S02035B					☆		CNGA432S0835B	
			2.3	.091	CNGA120412S01018A			☆	☆			CNGA433S0318A	
			2.7	.106	CNGA120412S01030A			☆	☆			CNGA433S0330A	
			2.3	.091	CNGA120412S01530B					☆		CNGA433S0630B	
			2.3	.091	CNGA120412S02035A			☆	☆			CNGA433S0835A	
			2.8	.110	CNGA120412S02035B					☆		CNGA433S0835B	
			2.6	.102	CNGA120416S01030A			☆	☆			CNGA434S0330A	
		2.7	.106	CNGA120416S02035A			☆	☆			CNGA434S0835A		

Note: Grade 7025 is uncoated.

Negative basic-shape inserts

T-Max® P

Rhombic 80°

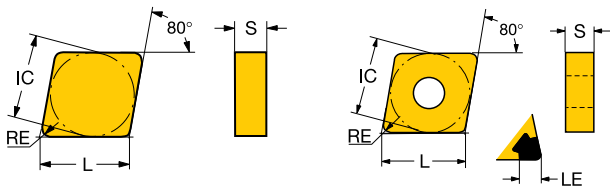

				ISO CODE	K		H			ANSI CODE		
					7525	7925	7015	7025	7525		CB20	
Finishing		12	1/2	2.8	.110	CNGA120404T01020B	☆				CNGA431T0320B	
				2.7	.106	CNGA120408T01020B	☆				CNGA432T0320B	
				2.0	.079	CNGA120408T01030A			☆		CNGA432T0330A	
				2.7	.106	CNGA120412T01020B	☆			☆	CNGA433T0320B	
				2.3	.091	CNGA120412T01030A			☆		CNGA433T0330A	
		12	1/2	2.0	.079	CNGA120408EA				☆	CNGA432AA	
				2.3	.091	CNGA120412EA				☆	CNGA433AA	
		12	1/2	2.8	.110	CNMA120404S01020E					☆	CNMA431S0320E
				2.8	.110	CNMA120408S01020E					☆	CNMA432S0320E
				2.7	.106	CNMA120412S01020E					☆	CNMA433S0320E
		12	1/2			CNGN120412S02520M	☆	☆				CNG433S0820M
						CNGN120416S02520M	☆	☆				CNG434S0820M





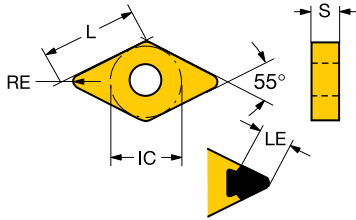

Note: Grade 7025 is uncoated.

Negative basic-shape inserts

T-Max® P

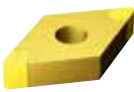
Rhombic 55°



		LE	LE"	ISO CODE	K				H				ANSI CODE	
					7525	7015	7025	7925	CB20	7525	7015	7025		7925
	15	1/2	3.4	.134	DNGA150408S01030AWH		☆	☆					DNGA432S0330AWH	
			2.1	.083	DNGA150408S02035AWH				☆	☆				DNGA432S0835AWH
			3.0	.118	DNGA150412S01030AWH				☆	☆				DNGA433S0330AWH
			2.4	.094	DNGA150412S02035AWH				☆					DNGA433S0835AWH
	11	3/8	1.8	.071	DNGA110404S01020A								DNGA331S0320A	
			3.0	.118	DNGA110404S01030A		☆	☆						DNGA331S0330A
			2.1	.083	DNGA110408S01020A				☆	☆				DNGA332S0320A
			2.6	.102	DNGA110408S01030A				☆	☆				DNGA332S0330A
			2.1	.083	DNGA110408S02035A				☆	☆				DNGA332S0835A
			2.2	.087	DNGA110412S01030A				☆					DNGA333S0330A
	15	1/2	1.8	.071	DNGA150404S01020A									DNGA431S0320A
			3.8	.150	DNGA150404S01030A		☆	☆						DNGA431S0330A
			1.8	.071	DNGA150404S02035A				☆	☆				DNGA431S0835A
			2.1	.083	DNGA150408S01020A				☆					DNGA432S0320A
			3.4	.134	DNGA150408S01030A				☆	☆				DNGA432S0330A
			2.1	.083	DNGA150408S01530B						☆			DNGA432S0630B
15	1/2	2.1	.083	DNGA150408S02035A		☆	☆						DNGA432S0835A	
		3.0	.118	DNGA150412S01030A		☆	☆						DNGA433S0330A	
		2.4	.094	DNGA150412S01530B						☆			DNGA433S0630B	
		2.4	.094	DNGA150412S02035A		☆	☆						DNGA433S0835A	
		2.9	.114	DNGA150416S01030A		☆	☆						DNGA434S0330A	
			11	3/8	3.4	.134	DNGA110404T01020B	☆					☆	
3.0	.118				DNGA110408T01020B	☆						☆		DNGA332T0320B
	15	1/2	2.1	.083	DNGA150408EA		☆						DNGA432AA	
			2.4	.094	DNGA150412EA		☆							DNGA433AA
			2.9	.114	DNGA150416EA		☆							DNGA434AA
	15	1/2	3.3	.130	DNMA150404S01020E							☆	DNMA431S0320E	
			2.9	.114	DNMA150408S01020E								☆	DNMA432S0320E
			2.6	.102	DNMA150412S01020E								☆	DNMA433S0320E

Note: Grade 7025 is uncoated.

Negative basic-shape inserts

T-Max®

Round

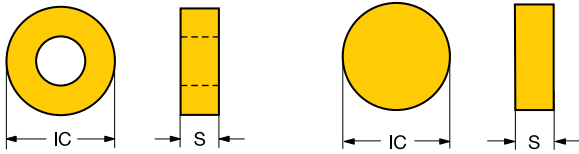









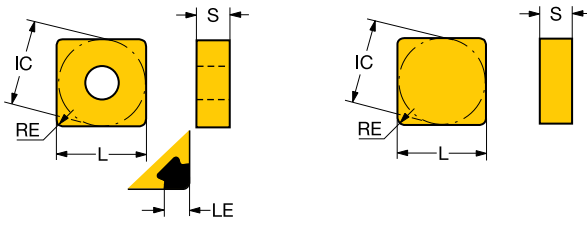



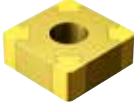

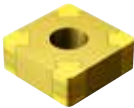

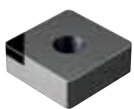
						K	H		
		7925	CB20	CB50					
		ISO CODE			ANSI CODE				
Finishing		06	1/4	RNGN060300S02520M	☆		RNG22S1020M		
				RNGN060400S02520M	☆		RNG23S1020M		
		09	3/8	RNGN090300S02520M	☆		RNG32S1020M		
		12	1/2	RNGN120300S02520M	☆		RNG42S1020M		
				RNGN120400S02520M	☆		RNG43S1020M		
		15	5/8	RNGN150400S02520M	☆		RNG53S1020M		
		25	1	RNGN250400S02520M	☆		RNG83S1020M		
Finishing		12	1/2	RNGN120400FD		☆	RNG43FD		
Medium		09	3/8	RNGA090300S01020D		☆	RNGA32S0320D		

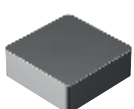
Negative basic-shape inserts

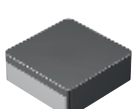
T-Max® P

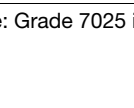
Square



			LE	LE"	ISO CODE	K		H				ANSI CODE			
						7525	7925	CB50	7015	7025	7525		CB20	CB50	
Finishing			3/8	2.1	.083	SNGA090308S01030A				☆	☆			SNGA322S0330A	
				1.4	.055	SNGA090308S02035B					☆			SNGA322S0835B	
				2.1	.083	SNGA090312S02035B						☆		SNGA323S0835B	
			1/2	2.7	.106	SNGA120408S01030A				☆	☆			SNGA432S0330A	
				2.7	.106	SNGA120412S01030A				☆	☆			SNGA433S0330A	
				2.7	.106	SNGA120412S02035A					☆			SNGA433S0835A	
				2.8	.110	SNGA120412S02035B						☆		SNGA433S0835B	
			3/8	2.1	.083	SNGA090308T01020B						☆		SNGA322T0320B	
				2.1	.083	SNGA090312T01020B						☆		SNGA323T0320B	
				2.7	.106	SNGA120408T01020B	☆					☆		SNGA432T0320B	
			1/2	2.7	.106	SNGA120412T01020B	☆					☆		SNGA433T0320B	
			1/2	3.4	.134	SNMA120404S01020E						☆		SNMA431S0320E	
				3.4	.134	SNMA120408S01020E						☆		SNMA432S0320E	
3.4				.134	SNMA120412S01020E							☆		SNMA433S0320E	
		3/8				SNGN090312S02520M		☆						SNG323S1020M	
			1/2				SNGN120412S02520M		☆						SNG433S1020M
							SNGN120416S02520M		☆						SNG434S1020M
		1/2				SNGN120408FD			☆			☆	SNG432FD		
						SNGN120412FD				☆			☆	SNG433FD	
						SNGN120416FD				☆			☆	SNG434FD	



Note: Grade 7025 is uncoated.

Negative basic-shape inserts

T-Max® P

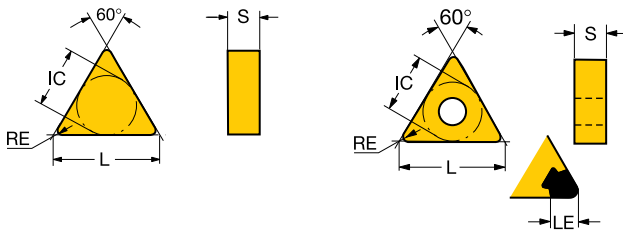
Triangular

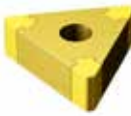
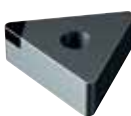
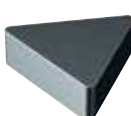
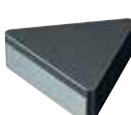

			LE	LE"	ISO CODE	K		H				ANSI CODE	
						7925	CB50	7015	7025	7525	CB20		CB50
	11	1/4	1.6	.063	TNGA110304S01030A			☆	☆				TNGA221S0330A
			1.3	.051	TNGA110308S01030A			☆	☆				TNGA222S0330A
	16	3/8	2.9	.114	TNGA160404S01030A			☆	☆				TNGA331S0330A
			2.6	.102	TNGA160408S01030A			☆	☆				TNGA332S0330A
			2.0	.079	TNGA160408S01530B					☆			TNGA332S0630B
			2.0	.079	TNGA160408S02035A				☆				TNGA332S0835A
			2.8	.110	TNGA160408S02035B					☆			TNGA332S0835B
			2.3	.091	TNGA160412S01030A			☆	☆				TNGA333S0330A
			2.3	.091	TNGA160412S02035A			☆					TNGA333S0835A
		16	3/8	3.6	.142	TNMA160404S01020E						☆	
			3.3	.130	TNMA160408S01020E						☆		TNMA332S0320E
			3.0	.118	TNMA160412S01020E						☆		TNMA333S0320E
22		1/2	3.2	.126	TNMA220408S01020E						☆		TNMA432S0320E
			2.9	.114	TNMA220412S01020E						☆		TNMA433S0320E
	16	3/8			TNGN160408S02520M		☆						TNG332S1020M
					TNGN160412S02520M		☆						TNG333S1020M
	22	1/2			TNGN220412FD		☆				☆		TNG433FD

Note: Grade 7025 is uncoated.

Negative basic-shape inserts

T-Max® P

Trigon 80°

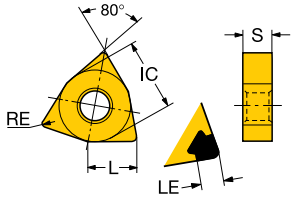

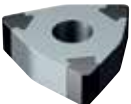
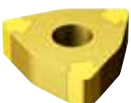
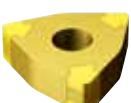
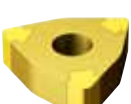
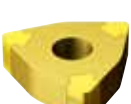
		LE	LE*	ISO CODE	K			H			ANSI CODE	
					7525	7015	7025	7525	7015	7025		
	06	3/8	2.3	.091	WNGA060404S01030AWH				☆		WNGA331S0330AWH	
			2.2	.087	WNGA060408S01030AWH				☆		WNGA332S0330AWH	
			2.7	.106	WNGA080404S01030AWH				☆		WNGA431S0330AWH	
	08	1/2	2.8	.110	WNGA080404S01030AWH				☆		WNGA431S0330AWH	
			2.7	.106	WNGA080408S01030AWH				☆		WNGA432S0330AWH	
			2.7	.106	WNGA080412S01030AWH				☆		WNGA433S0330AWH	
		06	3/8	2.3	.091	WNGA060404T01030AWH				☆		WNGA331T0330AWH
				2.2	.087	WNGA060408T01030AWH				☆		WNGA332T0330AWH
				2.7	.106	WNGA080404T01030AWH				☆		WNGA431T0330AWH
		08	1/2	2.8	.110	WNGA080404T01030AWH				☆		WNGA431T0330AWH
				2.7	.106	WNGA080408T01030AWH				☆		WNGA432T0330AWH
				2.7	.106	WNGA080412T01030AWH				☆		WNGA433T0330AWH
		06	3/8	2.3	.091	WNGA060404T01020BWG				☆		WNGA331T0320BWG
				2.2	.087	WNGA060408T01020BWG				☆		WNGA332T0320BWG
				2.7	.106	WNGA080404T01020BWG				☆		WNGA431T0320BWG
		08	1/2	2.8	.110	WNGA080404T01020BWG				☆		WNGA431T0320BWG
				2.7	.106	WNGA080408T01020BWG				☆		WNGA432T0320BWG
				2.7	.106	WNGA080412T01020BWG				☆		WNGA433T0320BWG
		06	3/8	2.3	.091	WNGA060404S01030A				☆	☆	WNGA331S0330A
				2.2	.087	WNGA060408S01030A				☆	☆	WNGA332S0330A
				2.7	.106	WNGA080404S01030A				☆	☆	WNGA431S0330A
		08	1/2	2.8	.110	WNGA080404S01030A				☆	☆	WNGA431S0330A
				2.7	.106	WNGA080408S01030A				☆	☆	WNGA432S0330A
				2.0	.079	WNGA080408S02035A				☆	☆	WNGA432S0835A
			2.7	.106	WNGA080412S01030A				☆	☆	WNGA433S0330A	
		06	3/8	2.3	.091	WNGA060404T01020B				☆		WNGA331T0320B
				2.2	.087	WNGA060408T01020B				☆		WNGA332T0320B
				2.7	.106	WNGA080404T01020B				☆		WNGA431T0320B
		08	1/2	2.8	.110	WNGA080404T01020B				☆		WNGA431T0320B
				2.7	.106	WNGA080408T01020B				☆		WNGA432T0320B
	2.7			.106	WNGA080412T01020B				☆		WNGA433T0320B	

Note: Grade 7025 is uncoated.

Negative basic-shape inserts

T-Max® P

Rhombic 35°

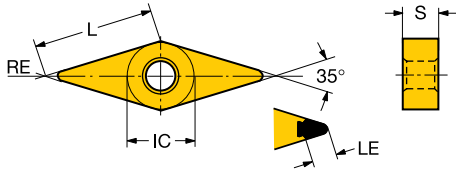

						H			
				LE	LE"	ISO CODE	7015	7025	ANSI CODE
Finishing		16	3/8	2.1	.083	VNGA160404S01020A	☆	☆	VNGA331S0320A
				4.2	.165	VNGA160404S01030A	☆	☆	VNGA331S0330A
				2.4	.094	VNGA160408S01020A	☆	☆	VNGA332S0320A
				3.3	.130	VNGA160408S01030A	☆	☆	VNGA332S0330A
				2.4	.094	VNGA160408S02035A	☆	☆	VNGA332S0835A

Note: Grade 7025 is uncoated.

Positive basic-shape inserts

CoroTurn® 107

Rhombic 80°

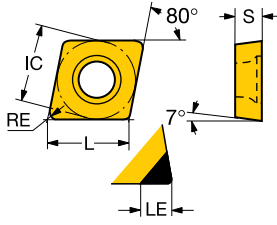

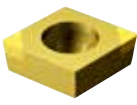
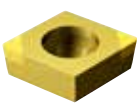
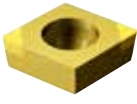
		LE	LE"	ISO CODE	K			H			ANSI CODE		
					7525	7015	7025	7525	7015	7025			
	09 3/8	2.6	.102	CCGW09T304S01020FWH							CCGW3(2.5)1S0320FWH		
		1.8	.071	CCGW09T304S01530FWH								CCGW3(2.5)1S0630FWH	
		2.6	.102	CCGW09T308S01020FWH								CCGW3(2.5)2S0320FWH	
		2.6	.102	CCGW09T312S01020FWH								CCGW3(2.5)3S0320FWH	
		06 1/4	1.8	.071	CCGW060204T01030FWH							CCGW2(1.5)1T0330FWH	
			2.0	.079	CCGW060208T01030FWH							CCGW2(1.5)2T0330FWH	
		09 3/8	2.6	.102	CCGW09T304T01020FWH								CCGW3(2.5)1T0320FWH
			2.5	.098	CCGW09T308T01020FWH								CCGW3(2.5)2T0320FWH
		06 1/4	1.8	.071	CCGW060204S01020F							CCGW2(1.5)1S0320F	
			1.8	.071	CCGW060204S01030F							CCGW2(1.5)1S0330F	
			2.0	.079	CCGW060208S01030F								CCGW2(1.5)2S0330F
			09 3/8	2.6	.102	CCGW09T304S01020F							CCGW3(2.5)1S0320F
09 3/8		1.8	.071	CCGW09T304S01530F								CCGW3(2.5)1S0630F	
		2.5	.098	CCGW09T308S01020F								CCGW3(2.5)2S0320F	
		2.0	.079	CCGW09T308S01530F								CCGW3(2.5)2S0630F	
		2.6	.102	CCGW09T312S01020F								CCGW3(2.5)3S0320F	
09 3/8		2.3	.091	CCGW09T312S01530F								CCGW3(2.5)3S0630F	
		06 1/4	1.5	.059	CCGW060202T01030F							CCGW2(1.5)0T0330F	
			2.6	.102	CCGW060204T01020F							CCGW2(1.5)1T0320F	
			1.8	.071	CCGW060204T01030F							CCGW2(1.5)1T0330F	
09 3/8	2.0	.079	CCGW060208T01030F								CCGW2(1.5)2T0330F		
	2.6	.102	CCGW09T304T01020F								CCGW3(2.5)1T0320F		
	2.5	.098	CCGW09T308T01020F								CCGW3(2.5)2T0320F		

Note: Grade 7025 is uncoated.

Positive basic-shape inserts

CoroTurn® 107

Rhombic 55°

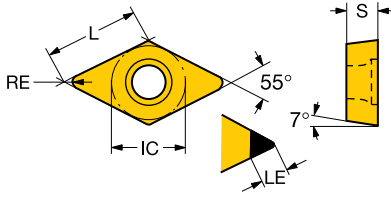

			LE	LE"	ISO CODE	K				H				ANSI CODE		
						7525	7015	7025	7525	CB20	7525	7015	7025		7525	CB20
Finishing		11	3/8	2.1	.083	DCGW11T308S01020FWH									DCGW3(2.5)2S0320FWH	
		07	1/4	1.8	.071	DCGW070204S01020F									DCGW2(1.5)1S0320F	
				1.8	.071	DCGW070204S01030F										DCGW2(1.5)1S0330F
				2.0	.079	DCGW070208S01030F										DCGW2(1.5)2S0330F
		11	3/8	1.8	.071	DCGW11T304S01020F										DCGW3(2.5)1S0320F
				1.8	.071	DCGW11T304S01530F										DCGW3(2.5)1S0630F
				2.8	.110	DCGW11T308S01020F										DCGW3(2.5)2S0320F
				2.1	.083	DCGW11T308S01530F										DCGW3(2.5)2S0630F
	2.4	.094	DCGW11T312S01020F											DCGW3(2.5)3S0320F		
	2.4	.094	DCGW11T312S01530F											DCGW3(2.5)3S0630F		
		07	1/4	1.5	.059	DCGW070202T01030F									DCGW2(1.5)0T0330F	
				3.2	.126	DCGW070204T01020F										DCGW2(1.5)1T0320F
		11	3/8	3.4	.134	DCGW11T302T01020F										DCGW3(2.5)0T0320F
				3.2	.126	DCGW11T304T01020F										DCGW3(2.5)1T0320F
2.1				.083	DCGW11T308T01020F										DCGW3(2.5)2T0320F	
	11	3/8	3.6	.144	DCMW11T304S01020E									DCMW3(2.5)1S0320E		
			3.4	.132	DCMW11T308S01020E										DCMW3(2.5)2S0320E	

Note: Grade 7025 is uncoated.

Positive basic-shape inserts

CoroTurn® 107

Rhombic 35°

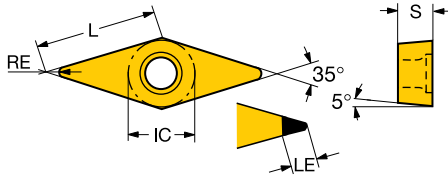

						K		H			
						7525	7015	7025	7525	ANSI CODE	
				LE	LE"	ISO CODE					
Finishing		16	3/8	4.2	.165	VBGW160404S01020F	☆	☆	☆	☆	VBGW331S0320F
				3.0	.118	VBGW160404S01030F	☆	☆	☆	☆	VBGW331S0330F
				3.1	.122	VBGW160404S01530F	☆	☆	☆	☆	VBGW331S0630F
				3.3	.130	VBGW160408S01020F	☆	☆	☆	☆	VBGW332S0320F
				3.1	.122	VBGW160408S01530F	☆	☆	☆	☆	VBGW332S0630F
		16	3/8	4.2	.165	VBGW160404T01020F	☆			☆	VBGW331T0320F
				3.3	.130	VBGW160408T01020F	☆			☆	VBGW332T0320F



Note: Grade 7025 is uncoated.

Positive basic-shape inserts

CoroTurn® 107

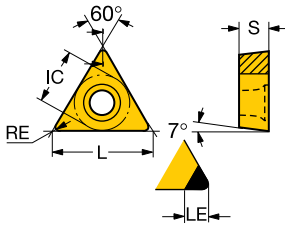
Triangular



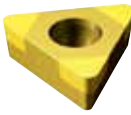
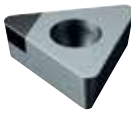

			LE	LE"	ISO CODE	K				H		ANSI CODE	
						7525	7015	7025	7525	CB20			
Finishing		09	7/32	3.2	.126	TCGW090202S01020F	☆	☆	☆	☆		TCGW1.8(1.5)0S0320F	
				3.0	.118	TCGW090204S01020F	☆	☆	☆		TCGW1.8(1.5)1S0320F		
				1.8	.071	TCGW090204S01030F	☆				TCGW1.8(1.5)1S0330F		
				1.8	.071	TCGW090204S01530F	☆	☆	☆		TCGW1.8(1.5)1S0630F		
				3.0	.118	TCGW110204S01020F	☆	☆	☆		TCGW2(1.5)1S0320F		
		11	1/4	1.8	.071	TCGW110204S01530F	☆	☆	☆		TCGW2(1.5)1S0630F		
				2.7	.106	TCGW110208S01020F	☆	☆		TCGW2(1.5)2S0320F			
				2.0	.079	TCGW110208S01530F	☆	☆	☆	TCGW2(1.5)2S0630F			
				3.0	.118	TCGW110304S01020F	☆	☆		TCGW221S0320F			
				1.8	.071	TCGW110304S01530F	☆			TCGW221S0530F			
				3.0	.118	TCGW110308S01020F	☆	☆		TCGW222S0320F			
				3.0	.118	TCGW110308S01530F	☆	☆	☆	TCGW222S0630F			
				3.2	.126	TCGW110202T01020F	☆		☆	TCGW2(1.5)0T0320F			
				3.0	.118	TCGW110204T01020F	☆		☆	TCGW2(1.5)1T0320F			
				2.8	.110	TCGW110304T01020F			☆	TCGW221T0320F			
3.0	.118	TCGW110308T01020F			☆	TCGW222T0320F							
		09	7/32	3.0	.118	TCMW090204S01020E				☆	TCMW1.8(1.5)1S0320E		
				11	1/4	3.0	.118	TCMW110304S01020E				☆	TCMW221S0320E
				3.0	.118	TCMW110308S01020E				☆	TCMW222S0320E		
				3.0	.118	TCMW110204S01020E				☆	TCMW2(1.5)1 S0320E		
				3.0	.118	TCMW110208S01020E				☆	TCMW2(1.5)2S0320E		

CoroTurn® 111

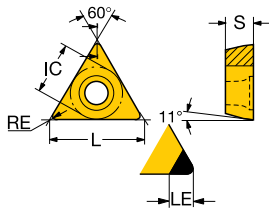
Triangular

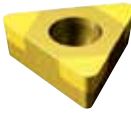

			LE	LE"	ISO CODE	K				H		ANSI CODE
						7525	7015	7025	7525	CB20		
Finishing		11	1/4	3.0	.118	TPGW110304S01020F	☆	☆	☆			TPGW221S0320F
				2.7	.106	TPGW110308S01020F	☆	☆			TPGW222S0320F	

Note: Grade 7025 is uncoated.

Positive basic-shape inserts

T-Max®

Square

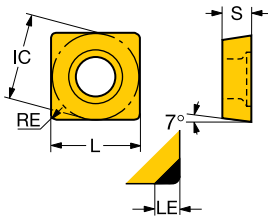

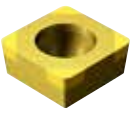
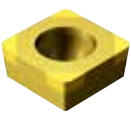



		LE	LE"	ISO CODE	H			ANSI CODE		
					7015	7025	7525			
Finishing		09	3/8	1.8	.071	SCGW09T304S01030F	☆	☆	☆	SCGW3(2.5)1S0330F
				2.1	.083	SCGW09T308S01030F	☆	☆	☆	SCGW3(2.5)2S0330F
				3.1	.122	SCGW09T308S01530F			☆	SCGW3(2.5)2S0630F
		09	3/8	2.8	.110	SCGW09T304T01020F			☆	SCGW3(2.5)1T0320F
				3.1	.122	SCGW09T308T01020F			☆	SCGW3(2.5)2T0320F
				3.1	.122	SCGW09T308T01530F			☆	SCGW3(2.5)2T0530F

Note: Grade 7025 is uncoated.

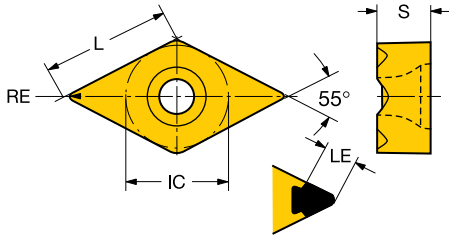
CoroTurn® TR



Rhombic 55°

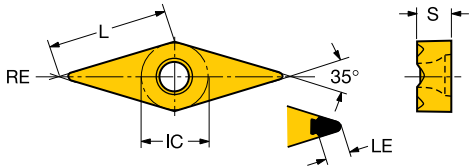

						H			
				LE	LE"	ISO CODE	7015	7025	ANSI CODE
Finishing		13	13	3.0	.118	TR-DC1304S01020F	☆	☆	TR-DC1304S01020F
				3.0	.118	TR-DC1308S01020F	☆	☆	TR-DC1308S01020F

Rhombic 35°



						H			
				LE	LE"	ISO CODE	7015	7025	ANSI CODE
Finishing		13	13	3.0	.118	TR-VB1304S01020F	☆	☆	TR-VB1304S01020F
				3.0	.118	TR-VB1308S01020F	☆	☆	TR-VB1308S01020F

Note: Grade 7025 is uncoated.

For code key, see Turning tools catalogue 2011.

CoroTurn® XS inserts

Turning

KAPR 98°
PSIR -8°

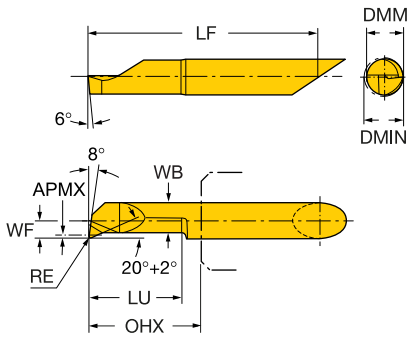

CZC MS	APMX	DMIN	DMM	LU	Ordering code	H 7015	Dimensions, mm, inch				
							RE	WB	WF	LF	OHX
04	0.20	1.7	4	6.0	CXS-04T098-10-1706R	☆	0.1	1.05	0.70	27.2	9
	.008	.067	.157	.236			.004	.041	.028	1.073	.354
	0.20	2.2	4	9.0	CXS-04T098-10-2209R	☆	0.1	1.55	0.95	27.2	12
	.008	.087	.157	.354			.004	.061	.037	1.073	.472
	0.20	2.7	4	10.0	CXS-04T098-15-2710R	☆	0.2	2.05	1.20	27.3	13
	.008	.106	.157	.394			.006	.081	.047	1.073	.512
	0.20	3.2	4	15.0	CXS-04T098-15-3215R	☆	0.2	2.55	1.45	32.3	18
	.008	.126	.157	.591			.006	.100	.057	1.270	.709
	0.20	3.7	4	15.0	CXS-04T098-15-3715R	☆	0.2	3.05	1.70	32.2	18
	.008	.146	.157	.591			.006	.120	.067	1.270	.709
	0.30	4.2	4	10.0	CXS-04T098-15-4210R	☆	0.2	3.45	1.95	27.3	13
	.012	.165	.157	.394			.006	.136	.077	1.073	.512
0.30	4.2	4	15.0	CXS-04T098-15-4215R	☆	0.2	3.45	1.95	32.3	18	
.012	.165	.157	.591			.006	.136	.077	1.270	.709	
0.30	4.2	4	20.0	CXS-04T098-15-4220R	☆	0.2	3.45	1.95	37.3	23	
.012	.165	.157	.787			.006	.136	.077	1.467	.906	
0.30	4.2	4	25.0	CXS-04T098-15-4225R	☆	0.2	3.45	1.95	43.3	28	
.012	.165	.157	.984			.006	.136	.077	1.703	1.102	
05	0.50	5.2	5	10.0	CXS-05T098-20-5210R	☆	0.2	4.25	2.4	32.2	13
	.020	.205	.197	.394			.008	.167	.096	1.270	.512
	0.50	5.2	5	20.0	CXS-05T098-20-5220R	☆	0.2	4.25	2.45	42.2	23
	.020	.205	.197	.787			.008	.167	.096	1.663	.906
	0.50	5.2	5	25.0	CXS-05T098-20-5225R	☆	0.2	4.25	2.45	47.2	28
	.020	.205	.197	.984			.008	.167	.096	1.860	1.102
0.50	5.2	5	30.0	CXS-05T098-20-5230R	☆	0.2	4.25	2.45	57.2	33	
.020	.205	.197	1.181			.008	.167	.096	2.254	1.299	
06	0.50	6.2	6	15.0	CXS-06T098-20-6215R	☆	0.2	5.25	2.95	37.2	18
	.020	.244	.236	.591			.008	.207	.116	1.467	.709
	0.50	6.2	6	20.0	CXS-06T098-20-6220R	☆	0.2	5.25	2.95	42.2	23
	.020	.244	.236	.787			.008	.207	.116	1.663	.906
	0.50	6.2	6	25.0	CXS-06T098-20-6225R	☆	0.2	5.25	2.95	47.2	28
	.020	.244	.236	.984			.008	.207	.116	1.860	1.102
	0.50	6.2	6	30.0	CXS-06T098-20-6230R	☆	0.2	5.25	2.95	52.2	33
	.020	.244	.236	1.181			.008	.207	.116	2.057	1.299
0.50	6.2	6	40.0	CXS-06T098-20-6240R	☆	0.2	5.25	2.95	62.2	43	
.020	.244	.236	1.575			.008	.207	.116	2.451	1.693	
07	0.50	7.2	7	25.0	CXS-07T098-20-7225R	☆	0.2	6.25	3.45	47.2	28
	.020	.283	.276	.984			.008	.246	.136	1.860	1.102
	0.50	7.2	7	30.0	CXS-07T098-20-7230R	☆	0.2	6.25	3.45	52.2	33
	.020	.283	.276	1.181			.008	.246	.136	2.057	1.299
	0.50	7.2	7	40.0	CXS-07T098-20-7240R	☆	0.2	6.25	3.45	62.2	43
	.020	.283	.276	1.575			.008	.246	.136	2.451	1.693
0.50	7.2	7	50.0	CXS-07T098-20-7250R	☆	0.2	6.25	3.45	72.2	53	
.020	.283	.276	1.968			.008	.246	.136	2.844	2.087	

For code key, see Turning tools catalogue 2011

R = Right hand

TSYC	Tolerances, mm				Tolerances, inch			
	RETOLL	RETOLU	LLTOLL	LLTOLU	RETOLL"	RETOLU"	LLTOLL"	LLTOLU"
CXS-xxT098..R/L	-0.02	0.02	-0.02	0.02	-.0008	.0008	-.0008	.0008

LLTOLL, LLTOLU Tolerances LF

CoroTurn® XS inserts

Grooving

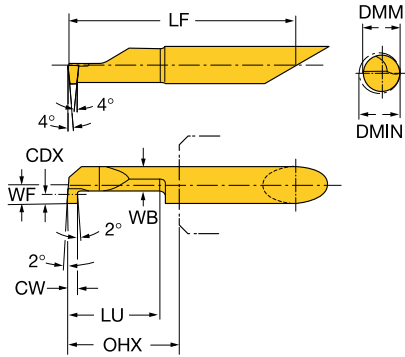

CZC MS	CDX	DMIN	DMM	LU	Ordering code	H 7015	Dimensions, mm, inch				
							WB	WF	LF	OHX	CW
06	1.8	6.2	6.0	15.0	CXS-06G100-6215R	☆	3.95	2.95	37.3	18	1.0
	.071	.244	.236	.591			.156	.116	1.469	.709	.039
	1.8	6.2	6.0	15.0	CXS-06G150-6215R	☆	3.95	2.95	37.3	18	1.5
	.071	.244	.236	.591			.156	.116	1.469	.709	.059

R = Right hand

Threading

V-profile 60°

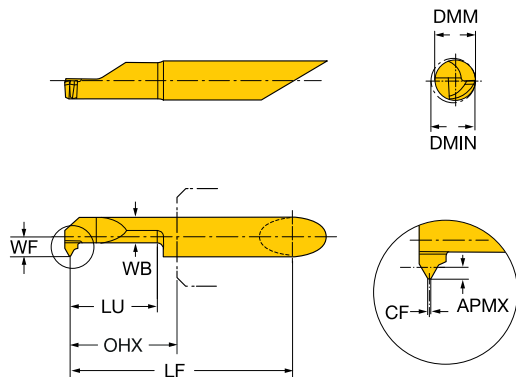

CZC MS	APMX	DMIN	DMM	LU	Ordering code	H 7015	Dimensions, mm, inch				
							WB	WF	LF	OHX	CF
06	0.55	6.2	6.0	15.0	CXS-06TH100VM-6215R	☆	3.55	2.95	37.3	18	0.12
	.022	.244	.236	.591			.140	.116	1.469	.709	.005
	0.81	6.2	6.0	15.0	CXS-06TH150VM-6215R	☆	3.55	2.95	37.3	18	0.18
	.032	.244	.236	.591			.140	.116	1.469	.709	.007

For code key, see Turning tools catalogue 2011

R = Right hand

TSYC	Tolerances, mm				Tolerances, inch			
	CWTOLL	CWTOLU	LLTOLL	LLTOLU	CWTOLL"	CWTOLU"	LLTOLL"	LLTOLU"
CXS-xxT098..R/L	-0	0.05	-0.02	0.02	-0	.002	-.0008	.0008

LLTOLL, LLTOLU Tolerances LF

CoroCut® 1- and 2-edge

Grooving

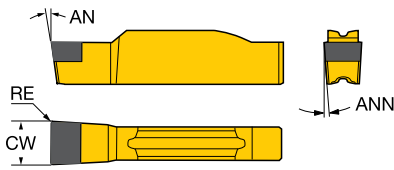
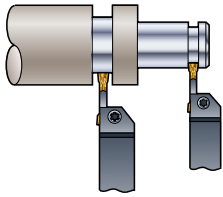

Tailor Made

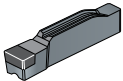
		Dimensions, mm, inch							H	
		SSC	CW	CW"	ANN	AN	RE	RE"	7015	CB20
Low feed		Ordering code								
		G	3.00	.118	7°	7°	0.20	.008	N123G1-0300-0002-GE	☆
			3.18	.125	7°	7°	0.20	.008	N123G1-0318-0002-GE	☆
		H	4.00	.157	7°	7°	0.20	.008	N123H1-0400-0002-GE	☆
			4.70	.185	7°	7°	0.20	.008	N123H1-0470-0002-GE	☆
			5.00	.197	7°	7°	0.20	.008	N123H1-0500-0002-GE	☆
		J	6.00	.236	7°	7°	0.20	.008	N123J1-0600-0002-GE	☆
		K	6.35	.250	7°	7°	0.20	.008	N123K1-0635-0002-GE	☆
		L	8.00	.315	7°	7°	0.20	.008	N123L1-0800-0002-GE	☆
		G	3.00	.118	7°	7°	0.40	.016	N123G1-030004S01025	☆
		H	4.00	.157	7°	7°	0.40	.016	N123H1-040004S01025	☆
			5.00	.197	7°	7°	0.40	.016	N123H1-050004S01025	☆
J	6.00	.236	7°	7°	0.40	.016	N123J1-060004S01025	☆		
L	8.00	.315	7°	7°	0.80	.031	N123L1-080008S01025	☆		

N = Neutral

For code key, see Turning tools catalogue 2011

TSYC	Tolerances, mm				Tolerances, inch			
	CWTOLL	CWTOLU	RETOLL	RETOLU	CWTOLL"	CWTOLU"	RETOLL"	RETOLU"
N123x1..S	-0.02	0.02	-0.05	0.05	-.0008	.0008	-.002	.002

CoroCut® 1- and 2-edge

Profiling

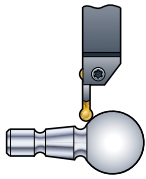

TSYC N123x1..S

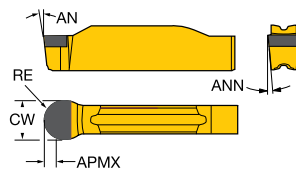

N/R/L123x1-RE

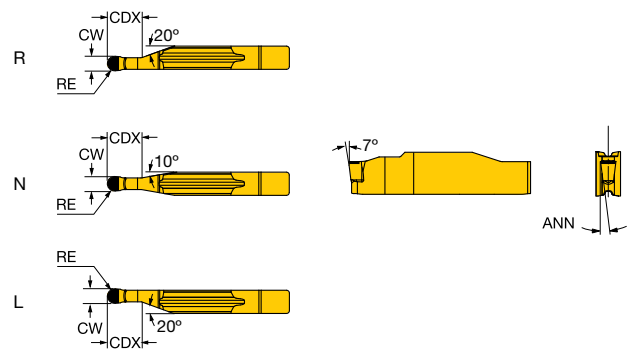

		Dimensions, mm, inch												H
		SSC	CW	CW"	ANN	AN	RE	RE"	APMX	APMX"	Ordering code		7015	
Low feed		F	3.00	.118	7°	7°	1.50	.059	1.30	.051	N123F1-0300S01025	☆		
		H	4.00	.157	7°	7°	2.00	.079	1.80	.071	N123H1-0400S01025	☆		
			5.00	.197	7°	7°	2.50	.098	2.30	.091	N123H1-0500S01025	☆		
		J	6.00	.236	7°	7°	3.00	.118	2.80	.110	N123J1-0600S01025	☆		

		Dimensions, mm, inch												H	
		SSC	CW	CW"	ANN	RE	RE"	CDX	CDX"	APMX	APMX"	Ordering code		7015	CB20
Low feed		H	2.00	.079	7°	1.00	.039	5.0	.197	0.80	.031	R/L123H1-0200-RE	☆		
			2.00	.079	7°	1.00	.039	5.0	.197	0.80	.031	N123H1-0200-RE	☆		
		F	3.00	.118	7°	1.50	.059			1.30	.051	N123F1-0300-RE	☆	☆	
			3.18	.125	7°	1.59	.063			1.40	.055	N123F1-0318-RE	☆	☆	
		H	4.00	.157	7°	2.00	.079			1.80	.071	N123H1-0400-RE	☆	☆	
			5.00	.197	7°	2.50	.098			2.30	.091	N123H1-0500-RE	☆	☆	
		J	6.00	.236	7°	3.00	.118			2.80	.110	N123J1-0600-RE	☆	☆	
			6.35	.250	7°	3.18	.125			3.00	.118	N123J1-0635-RE	☆	☆	
		L	8.00	.315	7°	4.00	.157			3.80	.150	N123L1-0800-RE	☆	☆	

For code key, see Turning tools catalogue 2011

N = Neutral, R = Right hand, L = Left hand

TSYC	Tolerances, mm				Tolerances, inch			
	CWTOLL	CWTOLU	RETOLL	RETOLU	CWTOLL"	CWTOLU"	RETOLL"	RETOLU"
N123x1..S	-0.02	0.02	-0.01	0.01	-0.0008	.0008	-0.004	.0004
N123x1-RE	-0.02	0.02	-0.01	0.01	-0.0008	.0008	-0.004	.0004
R/L123x1-RE	-0.02	0.02	-0.01	0.01	-0.0008	.0008	-0.004	.0004

CoroCut® MB inserts

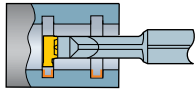

TSYC MB..G

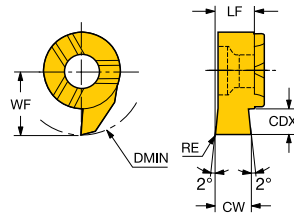

MB..T093

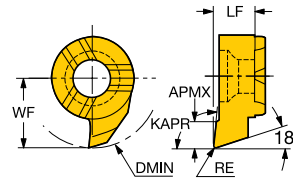

MB-xxTH..MM..R/L

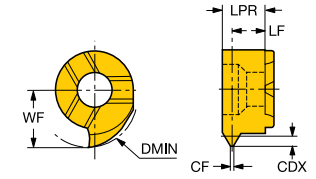

Grooving

							H		Dimensions, mm, inch							
		SSC	RE	RE"	CDX	CDX"	Ordering code	7015	DMIN	DMIN"	WF	WF"	LF	LF"	CW	CW"
		07	0	0	2.8	.110	MB-07G100-00-11R	☆	11.00	.433	6.8	.268	3.9	.154	1.0	.039
			0	0	2.8	.110	MB-07G150-00-11R	☆	11.00	.433	6.8	.268	3.9	.154	1.5	.059

R = Right hand

Turning

								H		Dimensions, mm, inch					
		SSC	RE	RE"	APMX	APMX"	KAPR	Ordering code	7015	DMIN	DMIN"	WF	WF"	LF	LF"
		07	0.20	.008	1.80	.071	93°	MB-07T093-02-10R	☆	10.00	.394	5.6	.220	3.9	.154

R = Right hand

Threading

Metric 60°

								H		Dimensions, mm, inch							
		SSC	CDX	CDX"	CF	CF"	TP	Ordering code	7015	DMIN	DMIN"	WF	WF"	LF	LF"	LPR	LPR"
		07	0.5	.021	0.12	.005	1.0	MB-07TH100MM-10R	☆	10.00	.394	5.8	.228	3.2	.126	3.8	.150
			0.8	.032	0.18	.007	1.5	MB-07TH150MM-10R	☆	10.00	.394	5.8	.228	3.0	.118	3.8	.150

For code key, see Turning tools catalogue 2011

R = Right hand

	Tolerances, mm						Tolerances, inch					
	CWTOLL	CWTOLU	RETOLL	RETOLU	LLTOLL	LLTOLU	CWTOLL"	CWTOLU"	RETOLL"	RETOLU"	LLTOLL"	LLTOLU"
TSYC												
MB..G	-0	0.05			-0.02	0.02	-0	.002			-0.008	.0008
MB..T093			-0.02	0.02	-0.02	0.02			-0.008	.0008	-0.008	.0008
MB-xxTH..MM..R/L					-0.02	0.02					-0.008	.0008

LLTOLL, LLTOLU Tolerances LF

CoroThread® 266

V-profile 60° Non-topping

Threading

TSYC 266R/LG..VM..A

266R/LL..VM..A

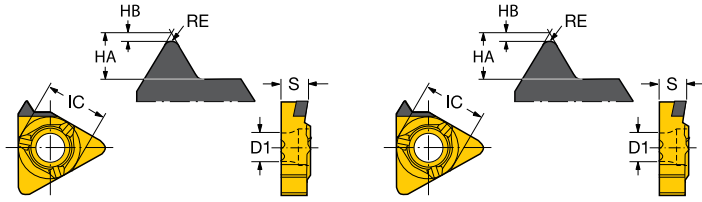

External

							H	Dimensions, mm, inch						
							7015	HA	HB	RE	IC	D1	S	
			TPN	TPX	TPIN	TPIX	Ordering code							
	16	3/8	1.0	2.0	12	24	266RG-16VM01A001EE	☆	1.68	0.14	0.13	9.53	4.4	3.97
									.066	.006	.005	.375	.173	.156
	16	3/8	1.5	3.0	8	16	266RG-16VM01A002EE	☆	2.64	0.20	0.20	9.53	4.4	3.97
									.104	.008	.008	.375	.173	.156

Internal

							H	Dimensions, mm, inch						
							7015	HA	HB	RE	IC	D1	S	
			TPN	TPX	TPIN	TPIX	Ordering code							
	16	3/8	1.5	3.0	8	16	266RL-16VM01A002EE	☆	2.54	0.09	0.09	9.52	4.4	3.97
									.100	.004	.004	.375	.173	.156

For code key, see Turning tools catalogue 2011

266R = Right hand

To make life easier, a new standard is developed

ISO 13399 is an international standard that will simplify the exchange of data for cutting tools. You will notice a slight difference, through the new parameters and descriptions of each tool.

For the first time ever, there is a standardized way of describing product data regarding cutting tools. When all tools in the industry share the same parameters and definitions, communicating tool information between software systems becomes very straightforward.

What does this mean to you?

Basically, it means that your systems can talk to ours, as they all speak the same language. Download product data from our web site and use it directly in your CAD/ CAM software to assemble tools that you use in production. No need to look for information in catalogues and interpret data from one system to another. Imagine how much time this will save you!

Parameters in Hard Part Turning 2012

Short name	Preferred Name
ANN	Clearance angle minor
APMX	Depth of cut maximum
BN	Face land width
CDX	Cutting depth maximum
CF	Spot chamfer
CW	Cutting width
CWTOLL	Cutting width lower tolerance
CWTOLU	Cutting width upper tolerance
CZC MS	Connection size code machine side
D1	Fixing hole diameter
DMIN	Minimum bore diameter
DMM	Shank diameter
GB	Face land angle
HA	Thread height theoretical
HB	Thread height difference
IC	Inscribed circle diameter
KAPR	Tool cutting edge angle
L	Cutting edge length
LE	Cutting edge effective length
LF	Functional length
LLTOLL	Length tolerance lower
LLTOLU	Length tolerance upper
LPR	Protruding length
LU	Usable length (max. recommended)
OHX	Overhang maximum
RE	Corner radius
RETOLL	Corner radius lower tolerance
RETOLU	Corner radius upper tolerance
S	Insert thickness
SSC	Insert seat size code
TP	Thread pitch
TPIN	Threads per inch minimum
TPIX	Threads per inch maximum
TPN	Thread pitch minimum
TPX	Maximum thread pitch
TSYC	Tool style code
WB	Body width
WF	Functional width
WSC	Clamping width
WT	Weight of item
W1	Insert width



**[www.sandvik.
coromant.com](http://www.sandvik.coromant.com)**

Head office:

AB Sandvik Coromant
SE-811 81 Sandviken, Sweden
www.sandvik.coromant.com
E-mail: info.coromant@sandvik.com