

High pressure coolant machining

for better productivity and results



What does high pressure coolant application contribute to machining?

High pressure coolant can provide the following benefits especially in challenging workpiece materials :

- higher machining security,
- consistent machining process,
- fewer machine stoppages,
- better component quality,
- shorter machining times,
- better utilization of machine capabilities.

These benefits can be applied to external and internal turning, milling and drilling through CoroTurn® HP, CoroMill® and CoroDrill® concepts.

When to apply high pressure coolant?	3
What is high pressure coolant?	4
How is high pressure coolant applied?	6
Broad application area	8
Compare the difference	10
Jet effect	12
Engineered solutions	13
How to get started with HPC	14
Turning titanium with HPC	16
Turning inconel with HPC	18
Turning stainless steels with HPC	20
Turning steel/aluminum with HPC	22
Pioneering that paved the way	23
Coromant Capto® - the basis for tooling	24
High pressure coolant - assortment	25

When to apply high pressure coolant

Defined role for coolants

The application of coolants in machining is undergoing somewhat of a re-evaluation. Many machine shops have used coolant in a conventional way, directing a tube which floods the machining zone. Today, some machine shops question the use of coolant altogether and introduce dry turning. Some use it only to control dust, chip evacuation or for finishing to achieve required surface quality and tolerance.

Strategic use of coolants

Just flooding the machining zone with coolant is not enough any more. If coolants are to be applied effectively they need to be applied through high pressure jets that are directed correctly. Such a jet, when controlled in a laminar flow, shortens the contact length between chip and rake face. In this form, coolants can affect how the generated heat is distributed and removed, the amount of tool wear generated, how chips are formed and broken as well as the amount of smearing of workpiece material on the cutting edge. This becomes especially important when machining demanding materials, where heat and chip control need extra measures.

The means are there, in place

Today, two main basic conditions are in place to improve machining with high pressure coolant: many CNC machines have coolant supplies at pressures of at least 1015 psi (70 bar) as standard or optional and many have a tool holding system that is suited for high pressure coolant supply. The challenge thus is to make better use of the available machine tool capability, using the best tooling system. The aim is to achieve the best balance of running time – the right continuous machining rate rather than excessive rates with numerous stoppages or rates that are unnecessarily low.

Even handling tools equipped with high pressure coolant is as easy and efficient as ordinary tools, with no operator settings of coolant jets. The benefits apply to both external and internal operations as well as grooving, profiling and pocketing.



Attractive payback

These production advantages will lead to a higher utilization of the available machine and available production time and thereby maximize the payback on investment. An optimized system with high pressure coolant machining can pay for itself in a few months.

While a system can be relatively easily retro-fitted to a machine and provide benefits, the big returns come with the equipment being specified along with a machine investment. Some benefits are achieved, to a lesser extent, even when coolants are applied through well-directed jets at lower pressures.

What is high pressure coolant?

Pressure, flow rate and coolant nozzle

High pressure coolant is more than pressure; it is coolant flow rate and coolant outlet size in the system, from pump to tool. The principle behind the application of high pressure coolant is that a reduction in the fluid outlet (nozzle on toolholder) produces an increase in the fluid velocity coming out of the nozzle. The larger the nozzle, the higher the flow rate of the fluid has to be in the tube and vice versa. Moreover, the number of nozzles (accumulated outlet area) will affect the resulting fluid outlet pressure. (The nozzle efficiency and fluid density are also factors.)

Thus, there is a proven theory (Bernoulli) that expresses the relationship between pressure, velocity and flow rate of a fluid, such as a coolant. As the fluid passes from a larger-diameter tube to a tube that is smaller in diameter, the flow rate requirements are smaller to achieve a high-velocity jet – the effect of putting a nozzle on the end of a garden hose. The larger the nozzle outlet diameter, the greater the flow rate requirement needed to deliver a certain pressure.



Constant velocity

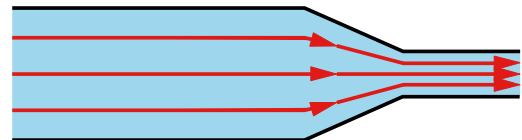

Increased velocity

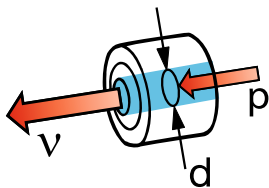

$$v = C_D \times n \times \frac{\pi d^2}{4} \times \sqrt{\frac{2p}{\rho}}$$

- Flow v expressed in m^3/s
- C_D - nozzle efficiency
 - 80% 20 to 300bars
 - 70% 300 to 1000bars
- d - nozzle diameter (m)
- p - pressure (Pa) - 1 bar = 0.1MPa
- ρ - fluid density - for water and cutting fluids the density is $\approx 1000 \text{ kg/m}^3$
- n - number of nozzles

Definitions

Pressure is force per unit of area on a plane in the fluid. Units are bar, psi or Pascal (N/square-meter).

Area is an imagined plane in the fluid in the tube.

Flow rate is the volume of fluid per time unit. Units are liters or gallons per minute.

Velocity of the fluid is distance per time unit. Units are meters or feet per second.

Key values for high pressure machining

In turning, the nozzle size recommended to produce a CoroTurn HP precision coolant jet with laminar flow is .039 inch (1 mm) in diameter.

A flow rate of at least 5.3 gallons (20 liters) per minute is recommended.

Exchangeable nozzles with outlet holes are available between .024 to .055 inch (0.6 to 1.4 mm).

The coolant pressure recommended for optimum CoroTurn HP turning, as well as for CoroMill milling and CoroDrill drilling, for high performance and results in most workpiece materials is 80 bar (1160 psi).

For each .039 inch (1 mm) nozzle being employed in the tool, a coolant flow-rate of 1.3 gallons (5 liters) per minute is required to maintain pressure. The variation in nozzle-outlet size should be used to maximize the pressure and utilize the available flow rate.

In milling, using multi-insert tooling, a higher flow rate is required in relation to the number of nozzles in use.

Flow requirement can be reduced by using nozzles with smaller outlet holes: (.039 inch (1 mm) diameter nozzle holes for up to ten outlets, .031 inch (0.8 mm) for ten to twenty outlets and .024 inch (0.6 mm) for more than twenty.

In drilling, the flow is as important as the pressure to ensure good chip evacuation through the flutes. High pressure helps to ensure good flow and therefore a secure drilling process. Coolant-hole sizes are optimized to the drill diameter and pump capability to maximize coolant flow. A relatively high flow rate is required to also efficiently evacuate chips out through flutes. For drill diameters smaller than .472 inch (12 mm), 4.2 gallons (16 liters) per minute is sufficient. For drill diameters .472 to 1.575 inch (12 to 40 mm), 8 gallons (30 liters) per minute and for over 1.575 inch (40 mm), 13 gallons (50 liters) will suffice.

A coolant pump capable of at least 13 gallons (50 liters) per minute is recommended when indexable insert milling cutters and drills over 1.575 inch (40 mm) are used – the higher capability, the better. A minimum coolant flow rate is 8 gallons (30 liters) per minute but standard pumps are available giving 20 gallons (75 liters) per minute.



How is high pressure coolant applied?

CoroTurn® HP

..... is a standard concept for external and internal turning of especially demanding materials with high pressure coolant. It is suited for application on lathes, multi-task machines, vertical turning machines and turning centers.

The toolholder is equipped with two to three nozzles positioned and directed depending upon the tool type and the application it is intended for. It will connect to the machine tool or extra pump equipment for supplying coolant at pressure needed, ideally at 1160 psi (80 bar). This supply is widely available and sufficient to improve performance and results, making good use of an asset many machine shops have already or can invest in for the future.



Optimization with high pressure coolant

The application of high pressure machining should not be seen as a means with which to compensate shortcomings due to other application factors – such as unsuitable inserts, instability, incorrect cutting data, etc. Basically CoroTurn HP is an optimizer when operations are correctly established. It will provide added means for even shorter cycle times, improved component quality consistency and higher process security.

CoroTurn HP is a standard turning product available in a range of toolholders in C4, C5, C6 and C8 sizes of the Coromant Capto system as well as in the CoroTurn SL modular blade system 32, 40 and 70.



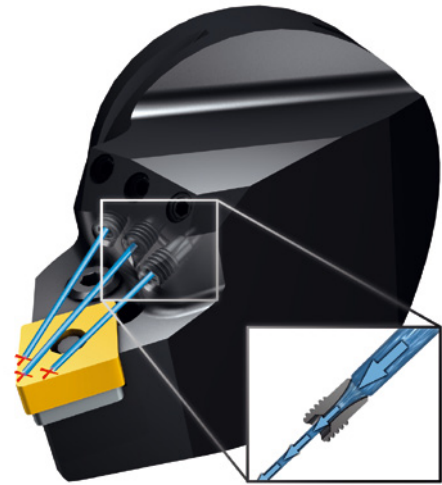

Fixed coolant-nozzle technology

The high pressure coolant application by way of CoroTurn® HP is based on carefully developed nozzle technology based on decades of experience. Optimized nozzles give parallel laminar jets of coolant with high velocity accurately directed at the right place on the insert. The precision and character of these jets make the difference. CoroTurn® HP has fixed, pre-directed, high precision nozzles mounted on the tool targeting the right place, at the right angle on the cutting edge. No setting with trials are needed; performance and security is built in with only normal tool maintenance required.



Silent Tools®

Broad application area

Internal turning

Operations, such as straight boring, profiling, grooving or pocketing, are characterized by being the most challenging with regard to applying the coolant optimally, achieving suitable chips and evacuating chips safely and efficiently. For high pressure coolant applications there are a number of CoroTurn HP solutions that provide the benefits for internal machining – whatever the depth of hole.

The CoroTurn SL 32 and 40 boring bars with a round serrated lock coupling between boring bar and cutting head provide high pressure coolant machining for a large range of internal operations as part of boring bars. Silent Tools dampening provides reliable boring when tool overhangs are more than 10 times the diameter complemented by carbide reinforced dampening bars for up to 14 times the diameter.

With the advantages that high pressure coolant and vibration-dampening machining provide, Silent Tools and CoroTurn HP solutions ensure high security and the right surface finish and tolerance levels while allowing larger depths of cut, a reduced number of passes and higher feed rates – all of which means optimizing productivity.

The large range of boring bar, adapter and toolholder alternatives provides the flexibility to build many different, optimized tools from a limited inventory. This suits configurations and gives accessibility in external or internal confined spaces using standard as well as engineered tooling.



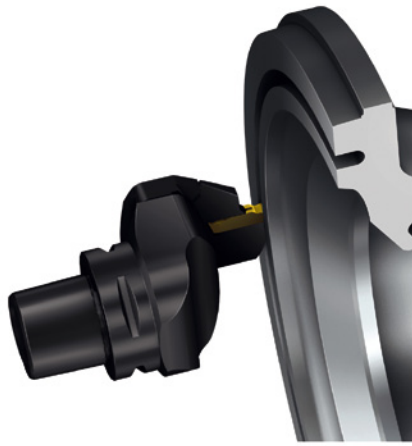

Grooving, profiling and pocketing

The typical, common geometrical features that occur in many aerospace and power related components make demands on accessibility in external and internal confined spaces. This background has formed the basis for developing the CoroTurn SL70 concept for grooving, pocketing and profiling with the aid of high pressure coolant. An oval, serrated-face type coupling - between the modular tooling adapter and the actual tool-blade holding the indexable insert - fulfills the requirements for stability and accuracy at long tool reach.

The range of SL70 blades in combination with Coromant Capto adapters, which present cutting edges at different angles and overhangs, give the flexibility to build optimized tools from a limited standard-tool inventory.

Blades, some of which have built-in dampening as specials, perform extended reach deep into angled grooves or pockets of various sizes and shape. CoroTurn HP then adds the benefit of a fixed, accurate high-pressure coolant jet supplied through the tool to the cutting edge. The high pressure coolant provides the means to more efficiently machine materials typical in these types of components through reducing heat accumulation, improving chip breaking and also assisting in evacuating chips from recesses. As such, it changes a turning operation, which has by tradition been problematic, into a secure and productive process.

Multi-task machine benefit

Along with lathes and turning centers, the rising population of multi-task machines have also highlighted the benefits of turning with high pressure coolant especially from the chip control point of view. The disturbance due to stringy-chip accumulation when machining demanding alloys is critical as these machines are increasingly used by machine shops making aerospace, oil-industry and other similar components. Particularly when there is automated tool changing, long chips present a high risk to reliable unmanned production.

High pressure coolant machining targets these applications with the ability to force a fluid wedge into the machining zone, especially in turning operations classified as medium to finish turning, where the chip thickness is more controllable and chip breaking is generally more of a challenge.



Compare the difference

Better chip control in all materials

A sample of some of the impressive results from various materials at a depth of cut of 0.25 mm (0.01 inch) and a feed rate of 0.15 mm/rev (0.006 inch/rev).

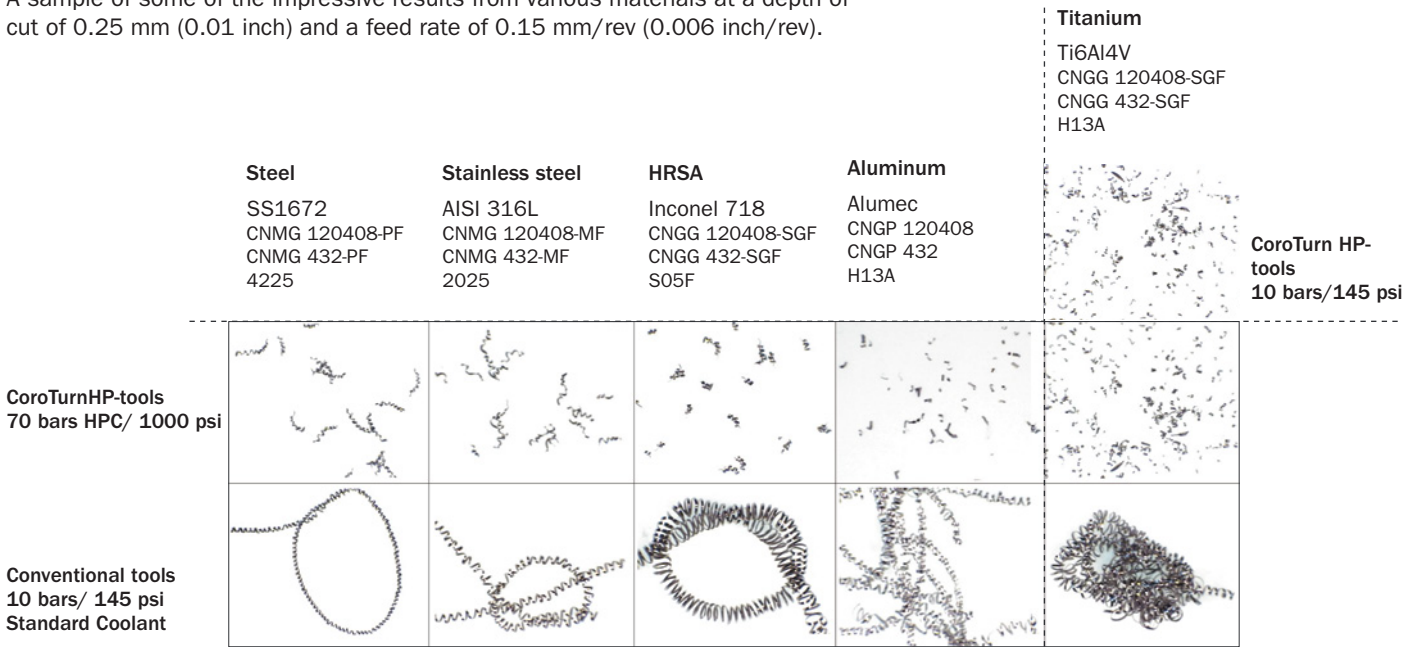

Higher removal rate

The tests below show the result of metal removed with CoroTurn HP in different materials.

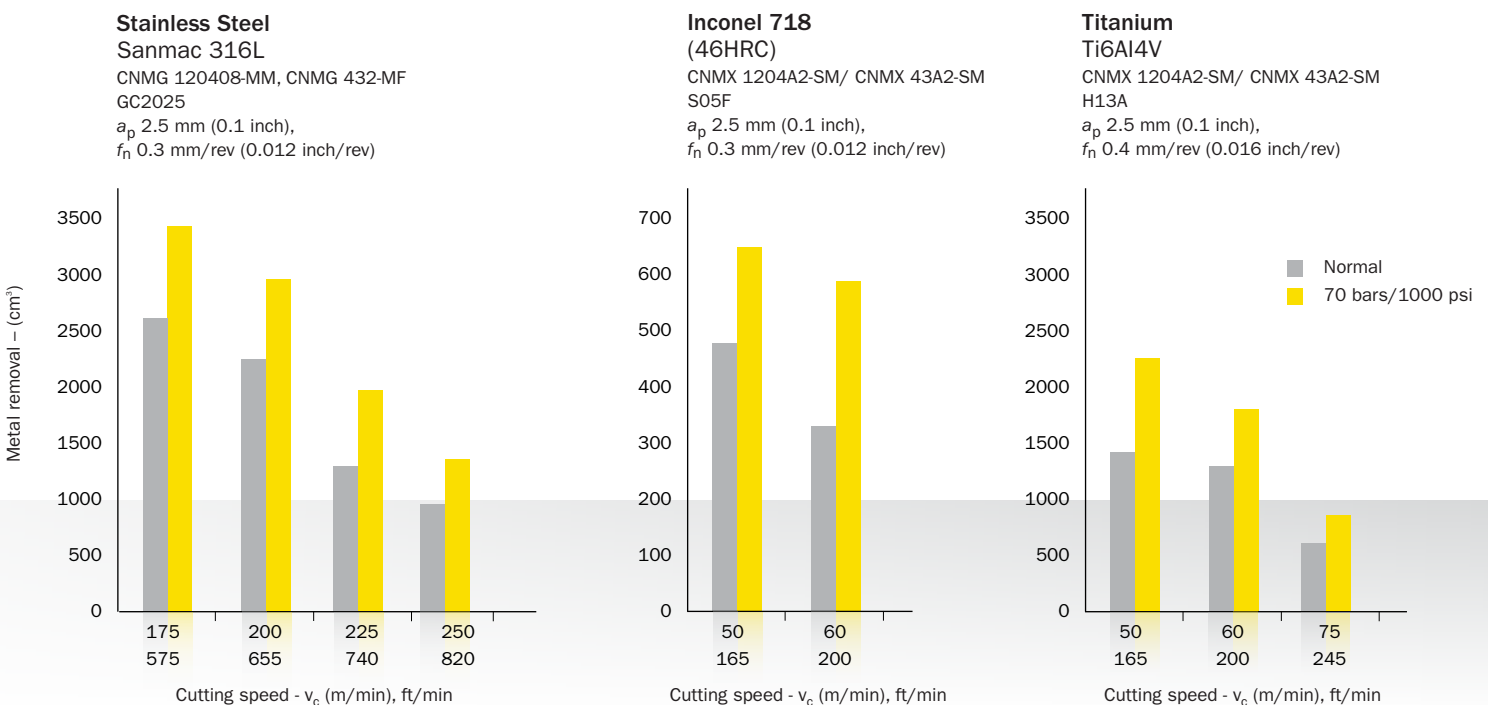

High pressure implemented result

Material	Titanium
Component	Disc – 2nd stage high pressure compressor
Competitor	Standard coolant – RCMT 10T3M0-SM H13A
Cutting parameters	v_c 60 m/min ; f_z 0.15 mm/rev ; a_p 1 mm v_c 200 sfm ; f_z 0.006 inch/rev ; a_p 0.04 inch
Coromant solution	SL70 - RCMT 10T3M0-SM H13A
Coromant cutting parameters	v_c 90 m/min ; f_z 0.35 mm/rev ; a_p 1.5 mm v_c 300 sfm ; f_z 0.014 inch/rev ; a_p 0.59 inch
Success factor	Higher metal removal rate Improved chip control
	<p>Cycle time reduced from 184 mins to 128 mins 42% productivity increase</p> <p>1523 hours saved in production/year</p>

Jet effect

Control of heat generation

At today's high machining rates using modern cemented-carbide indexable inserts, if coolant is applied conventionally into the machining zone with temperatures up to a thousand degrees C, instant evaporation takes place. This then leads to the formation of a pressurized vapor zone which prevents the effective flow of low-pressure coolant to reach the cutting edge. One answer to this is dry machining which does away with the costs of coolants altogether, as is often recommended in milling operations.

However, some of the more demanding materials are best machined by applying coolants because of the heat generated. If strategically applied, in well-directed jets at high-pressure, coolants can be advantageous in several applications by reducing the length of contact between chip and insert and consequently the heat generated.

The temperature generated when machining titanium and heat resistant super-alloys is high, mainly due to the high strength and poor thermal conductivity. The heat is concentrated due to the very highly sheared chips with a short contact length between the chip and the rake face – this contact zone is generally only half that of steel.

Effectively cooling the machining zone is today an easily-applied means with which to minimize tool wear, prolong tool life and provide a potential for higher cutting speed.

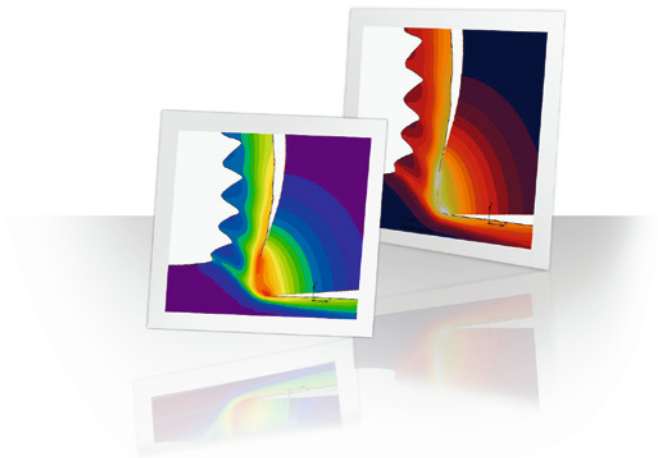

Coolant pressure
10 bar/ 145 psi

HPC
70 bar/ 1000 psi

1.



2 passes



4 passes

2.



4 passes



8 passes

Standard Ø32 CoroMill 390-17- full slot

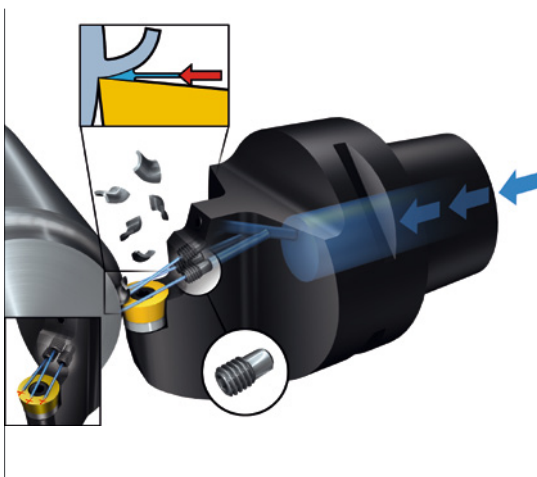

Control of chip formation

Turning with high pressure coolant means improved chip control. The laminar jet accurately directed at the cutting edge with the fixed-nozzle solution of CoroTurn HP produces a hydraulic wedge between chip and insert, reducing the shear plane angle through the force of the jet acting on the chip. In so doing, the wedge reduces the tendency for built-up edge and the jet helps to lift the chip, thereby curling and breaking it more rapidly.

Also the cooling effect on the chip helps to make the chip more brittle and easier to break.

A marked improvement of chipbreaking in turning is achieved with high pressure coolant in all workpiece materials characterized by troublesome chip formation. This results in a dramatic effect on both machining security, through less risk of chip entanglement, machine stoppage to clear chips and the amount of operator supervision needed.

Engineered solutions

Extended offer

Sandvik Coromant's standard tools are a good platform for optimized solutions utilizing high pressure coolant. However, sometimes engineered solutions dedicated to specific applications are needed. In the examples below the high pressure coolant technique is used to obtain chip control, tool life and process security.

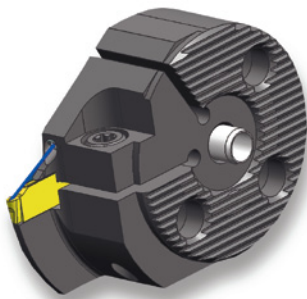

CoroTurn SL cutting head with reduced overhang for maximum stability and rigidity when machining to close tolerances with CoroCut-RO standard inserts.



External Coromant Capto unit for pressures over 1160 psi (80 bar) (Ultra High Pressure Coolant). UHPC is generally recommended for titanium. Chip breaking in heat resistant materials and improved performance are also possible.

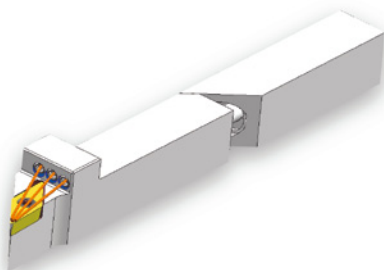

Short holders for QS holding systems dedicated to sliding head machines. Use together with standard CoroTurn 107 D and V-style inserts or with CoroCut XS. The solution combines the benefit of easy changing of the tool holder with the benefits of high pressure coolant giving better surfaces and tolerances.

Please contact your local Sandvik Coromant representative for more information about our non-standard offer for high pressure coolant tools.



How to get started with HPC

Most modern machine tools, already installed in machine shops, can be retrofitted with high pressure pumps. But introducing equipment post-installation will inevitably lead to some disruption in production with redundant hardware as a result when the advantages become apparent.

Equipping a machine with high pressure coolant is best done as part of the purchase for a new plant and equipment. This is to minimize costs and to ensure that programs and cutting data reflect new technology capability. It is an advantage to have the full picture right from the start.

When specifying the equipment, the following should be ensured :

- Machine capability – should be specified to run with pressures of up to 80 bar (1160 psi); check seals and valves.
- High pressure option – make sure that in the machine package the correct M-codes are available for operating the coolant pump.
- Pump selection – the volume capability has to be confirmed. Often the pressure is checked but the volume needs to be as well. The pump volume should be 20 liters (5 gallons) per minute for normal turning operations.
- Pumps for multi-task machines, or when large-diameter drills are used on lathes, as the volume requirement is greater. For these applications it is recommended to have pump volumes from 40 up to 80 liters (10-20 gallons) per minute.





- For applications requiring high volumes of coolant, a machine option where variable pressure is available can be very useful to have.
- Spindle interface - confirm with machine tool supplier that this is Coromant Capto. The system is a standard, integrated rotating-spindle option on most multi-task machines and vertical turning lathes (C6 or C8). For turning centers, machine adapted clamping units are available with Coromant Capto (C3, C4 or C5). The standard high-pressure program has been concentrated around the C5, C6 and C8 sizes as these are the most popular sizes for industries wanting to use high pressure tools - a plug and play solution.
- Tool selection - consultation with Sandvik Coromant at an early stage always pays off. It's especially beneficial to discuss the best insert shape and entry angle of turning tools. The insert shape selection, regardless of pressure, has a dramatic effect on metal removal and insert consumption rates.
- Programming – maximize cutting speeds or cutting length before indexing. Utilize the spiral cutting length (SCL) for long cuts to define where program stops. (M0) should be added.
- Production – green light production, a ‘foot down and feet up’ approach, requiring speed capability and secure production, is the goal for machining with high pressure coolant as part of the application.

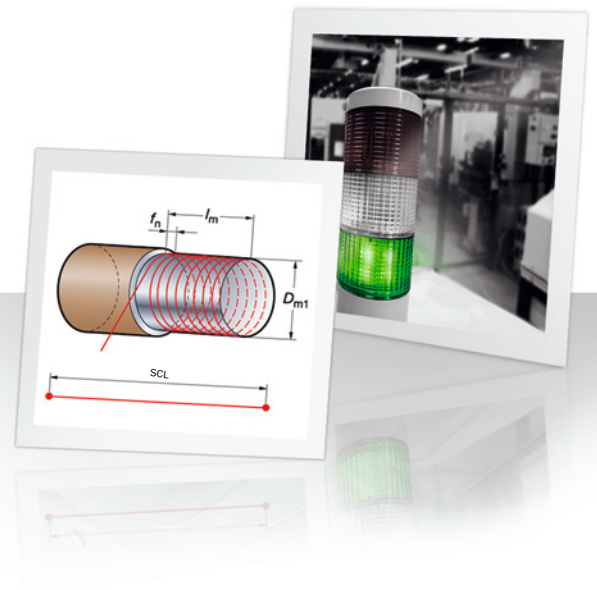

Turning titanium with HPC

Titanium - Ti6Al4V (30HRC)

CNMG 120408-SM H13A - v_c 60 m/min, a_p 1.5 mm, f_n 0.25 mm/rev

CNMG 432-SM H13A - v_c 200 sfm, a_p 0.06 inch, f_n 0.009 inch/rev

Normal pressure

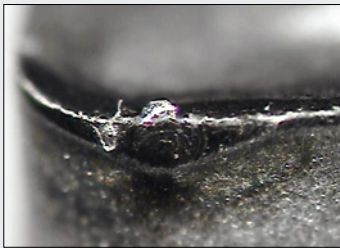

2.5 min

80 bars, 1160 psi

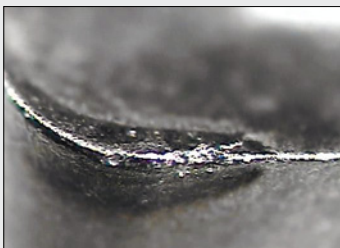

2.5 min

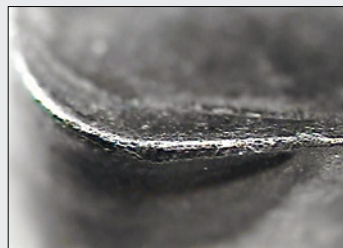

8 min

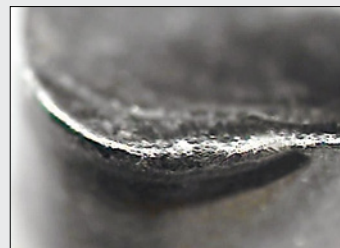

10.5 min

Titanium - Ti6Al4V (30HRC)

Total material removed (TMR)

CNMX 1204A2-SM H13A - a_p 2.5 mm, f_n 0.4 mm/rev

CNMX 43A2-SM H13A - a_p 0.1 inch, f_n 0.016 inch/rev

Total material - Q (cm³)

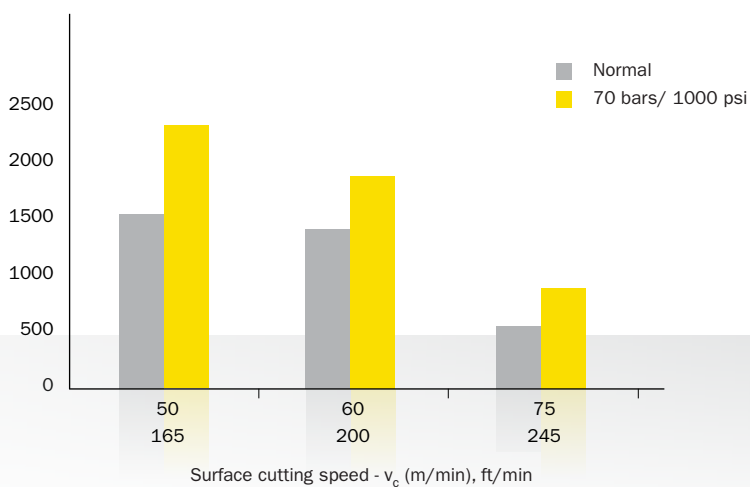

- With CoroTurn HP 70 bars
 - Metal removal +50% at same speed
 - Cutting speed +20% with +20% total metal removal

Titanium - Ti6Al4V (30HRC)

Chip control

CNGP 120408 H13A - v_c 60 m/min

CNGP 432 H13A - v_c 200 sfm

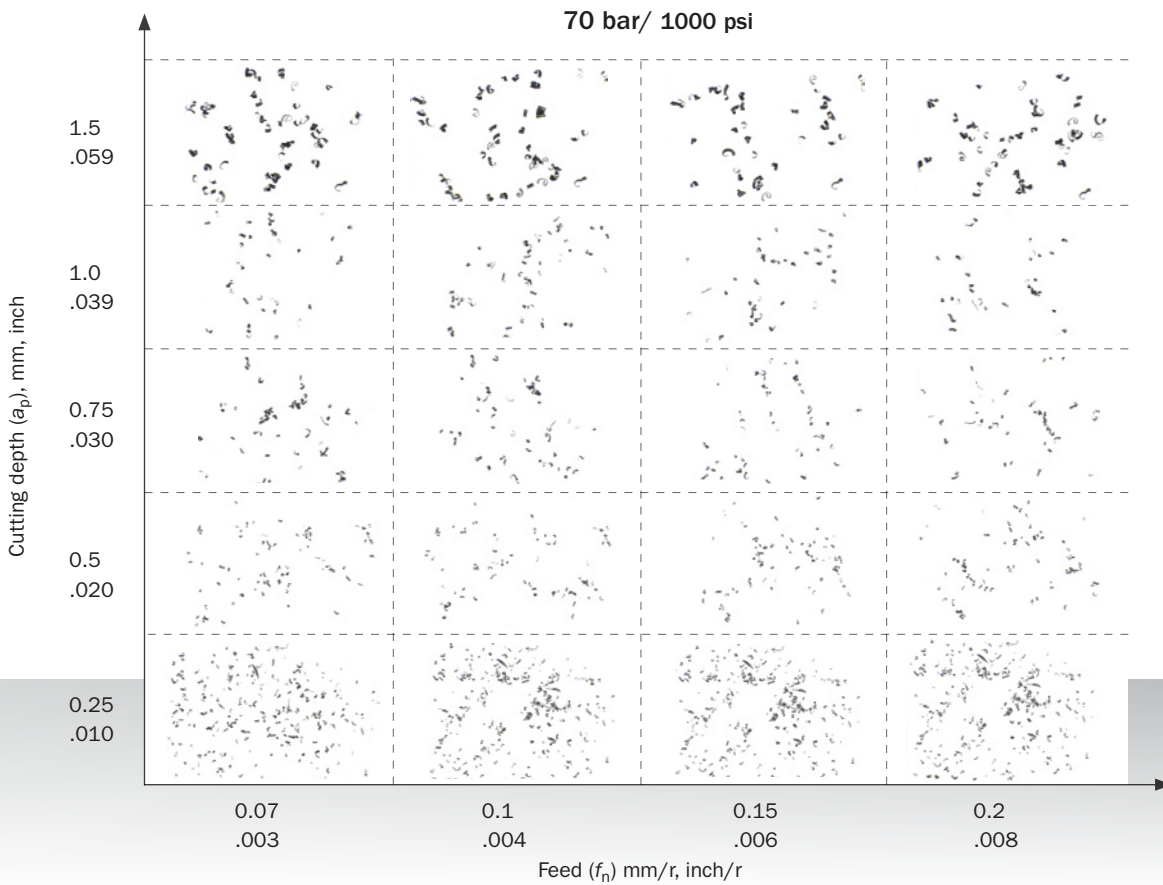
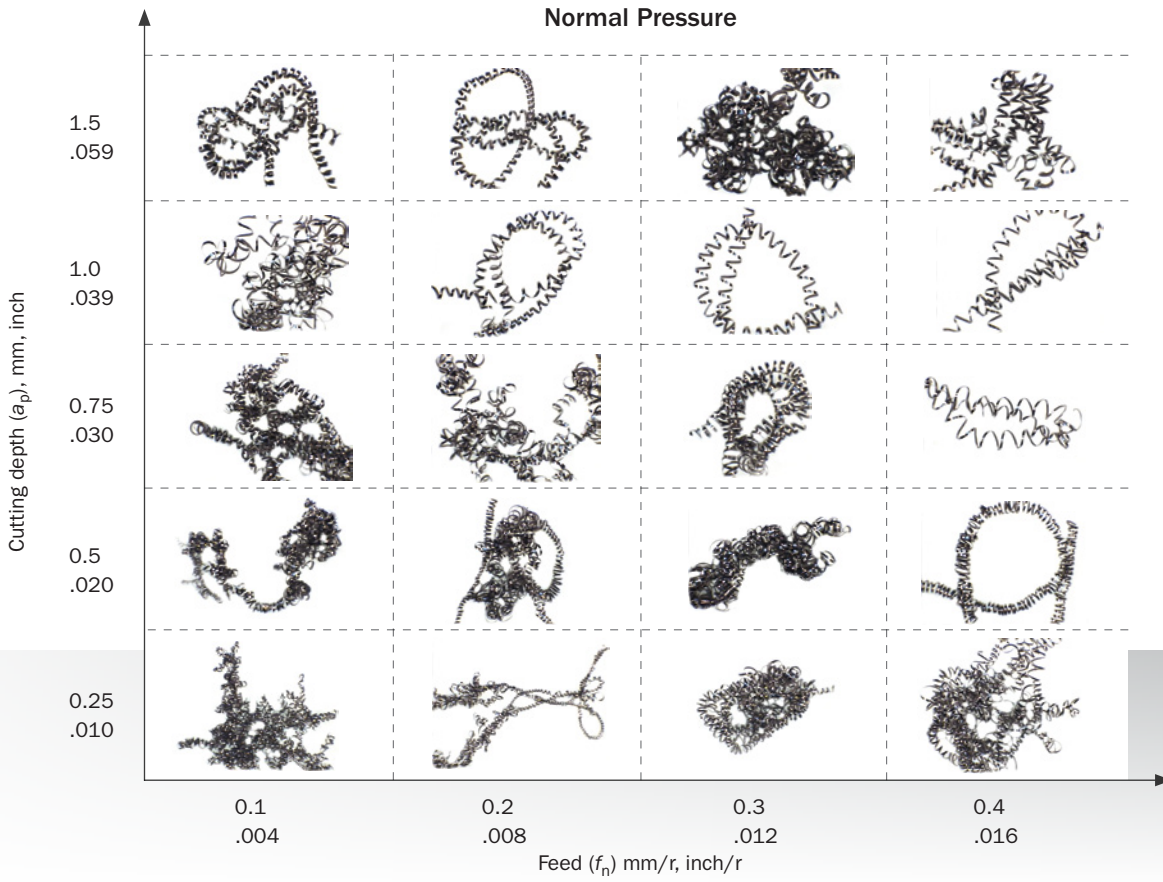

Turning inconel with HPC

Inconel 718 (46HRC)

Demonstration

CNGG 120408-SGF 1105 - a_p 0.25 mm, f_n 0.15 mm/rev

CNGG 432-SGF 1105 - a_p 0.01 inch, f_n 0.006 inch/rev



CoroTurn® RC
normal pressure



CoroTurn® HP
80 bars, 1160 psi

Inconel 718 (46HRC)

Total material removed (TMR)

CNMX 1204A2-SM S05F - a_p 2.5 mm, f_n 0.3 mm/rev

CNMX 43A2-SM S05F - a_p 0.1 inch, f_n 0.012 inch/rev

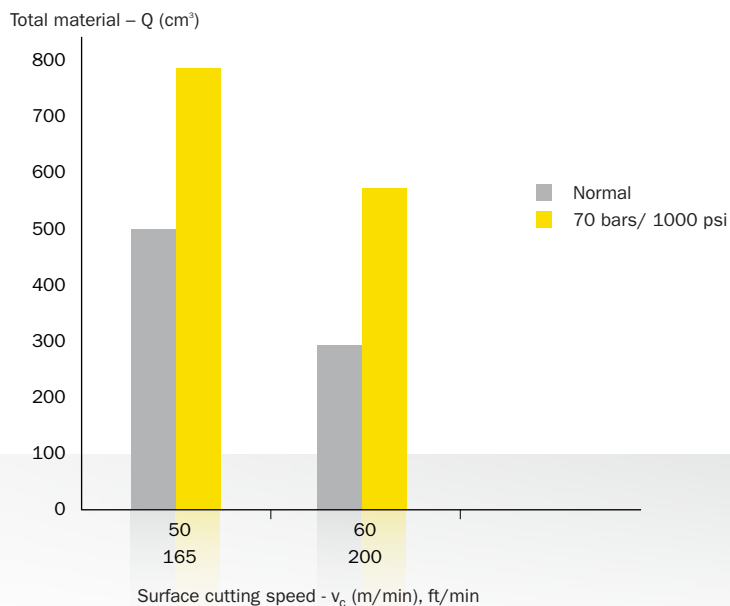

- **With CoroTurn HP 70 bars**
 - Metal removal +50% at same speed
 - Cutting speed +20% with +20% total metal removal

Inconel 718

Chip control

CNGG 120408-SGF - v_c 65 m/min

CNGG 432-SGF - v_c 210 sfm

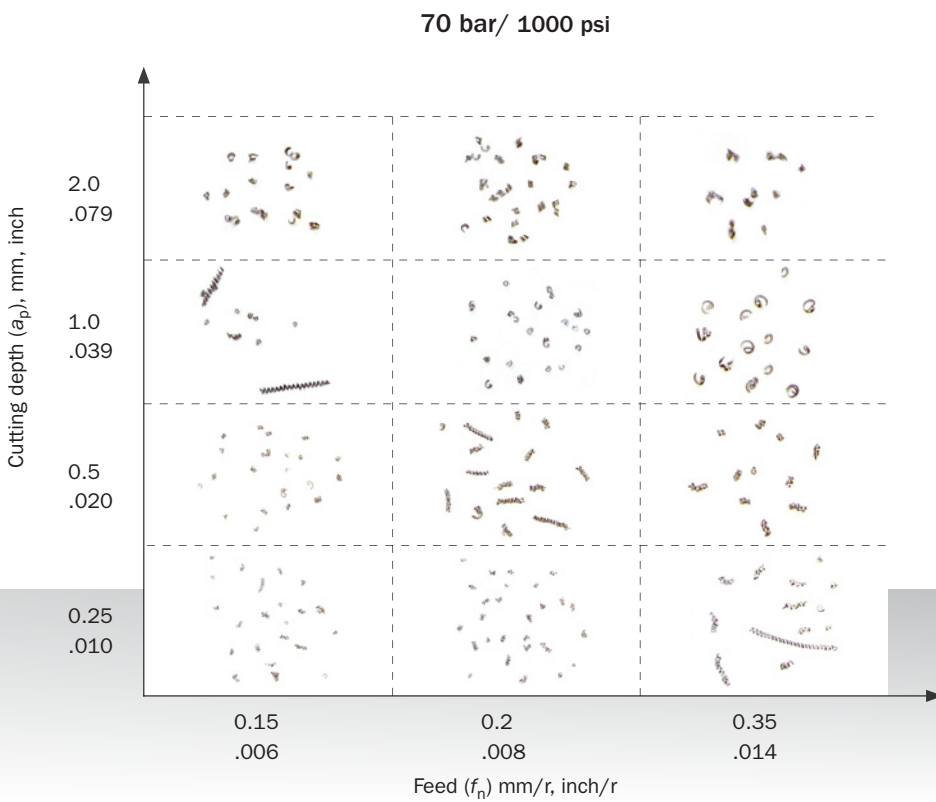
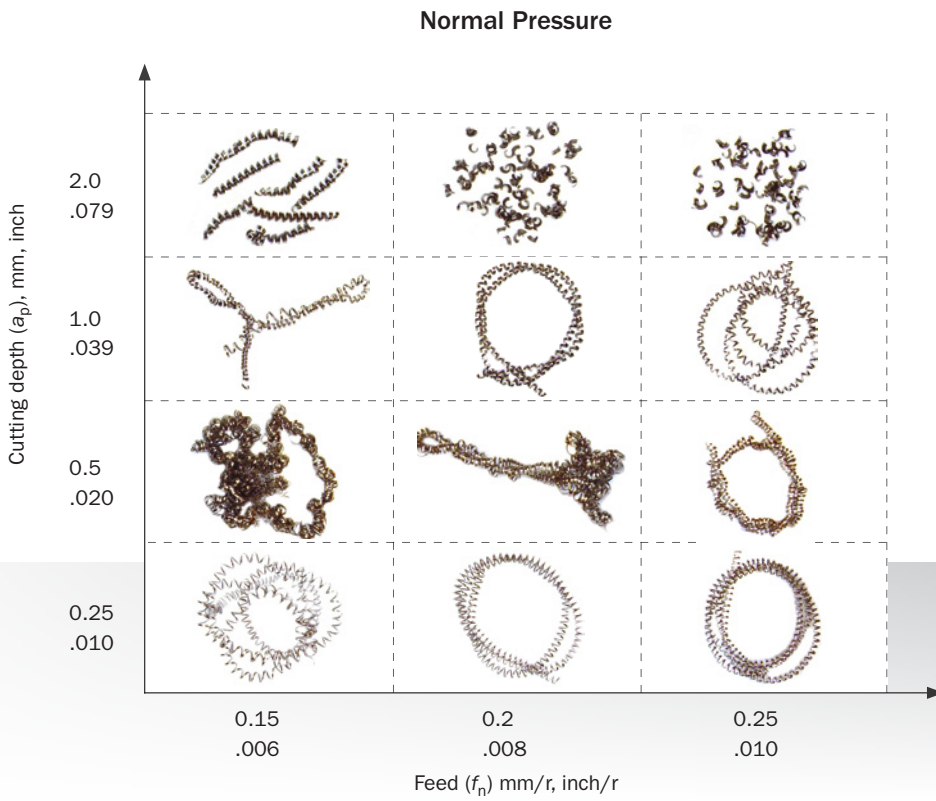

Turning stainless steels with HPC

Stainless steel - 316L

CNMG 120408-MF 2015 - v_c 250 m/min, a_p 0.4 mm, f_n 0.20 mm/rev

CNMG 432-MF 2015 - v_c 820 sfm, a_p 0.016 inch, f_n 0.008 inch/rev

7 bar/100 psi - 18.3 min

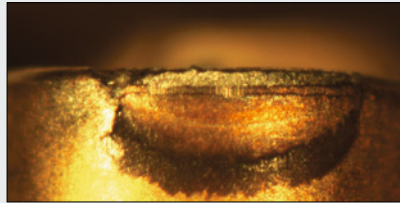

70 bar/1000 psi - 40 min

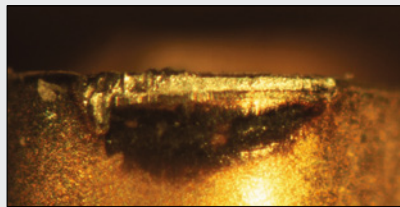

Stainless steel - Sanmac 316L

Total material removed

CNMG 120408-MM 2025 - a_p 2.5 mm, f_n 0.3 mm/rev

CNMG 432-MM 2025 - a_p 0.1 inch, f_n 0.012 inch/rev

Total material – Q (cm³)

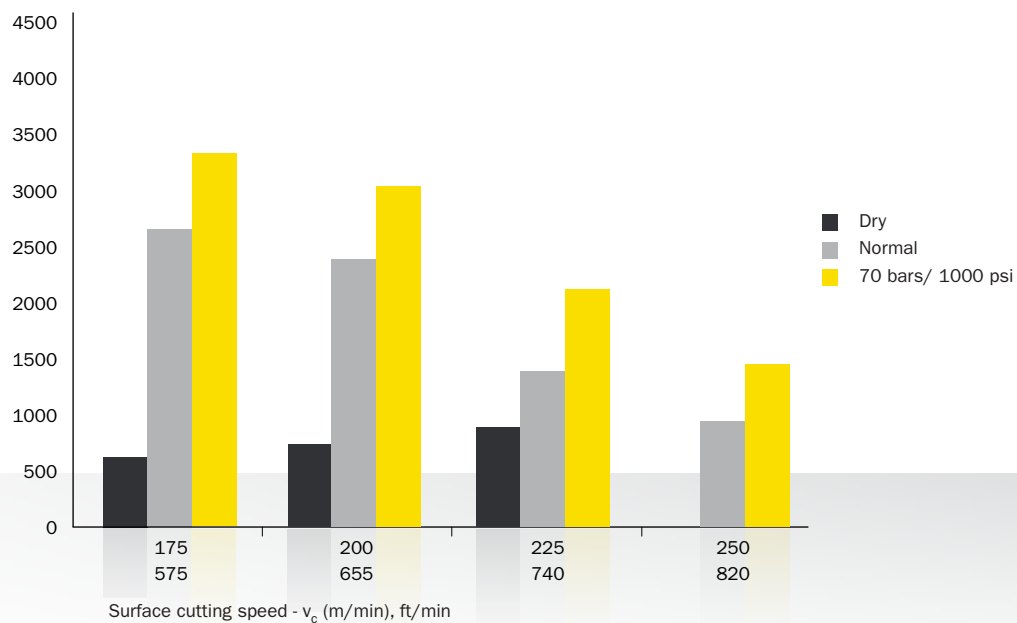

Stainless steel

Sanmac 316L

CNMG 120408-MF 2025 - v_c 200 m/min

CNMG 432-MF 2025 - v_c 650 sfm

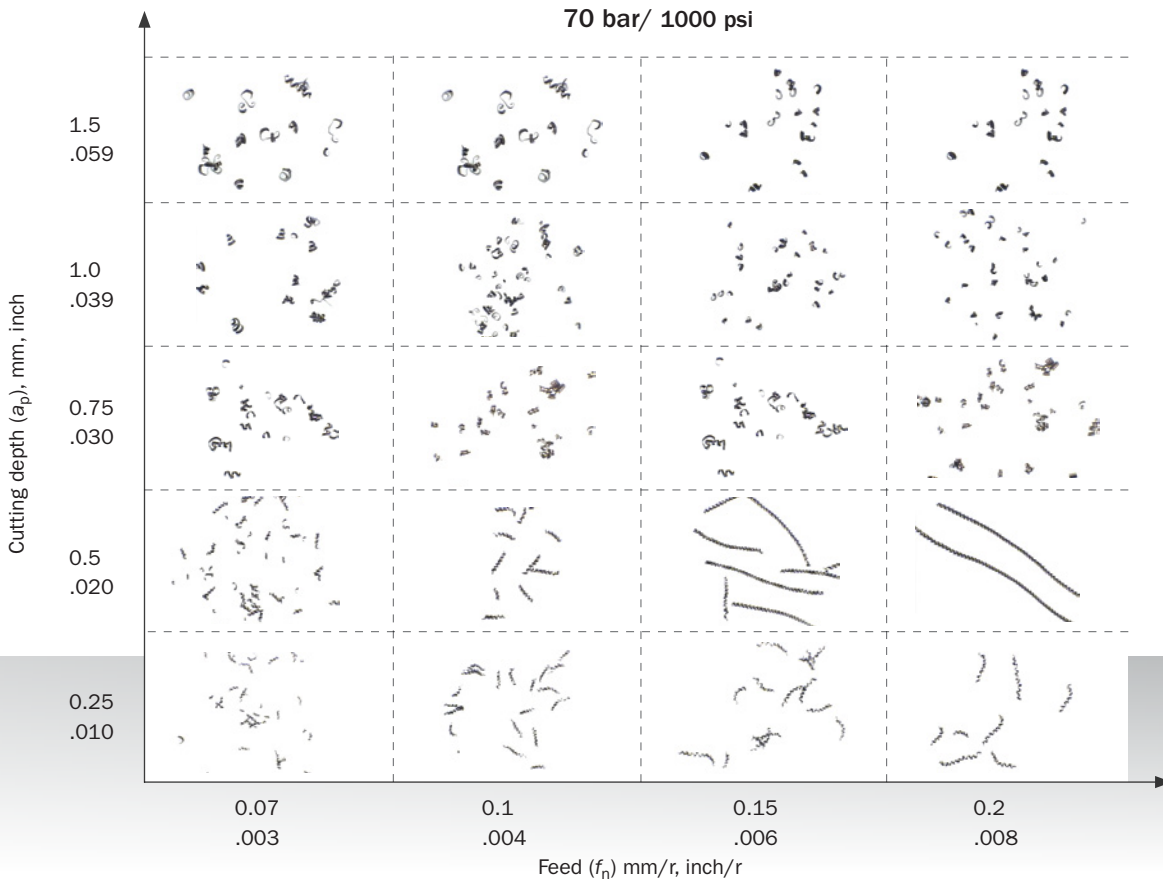
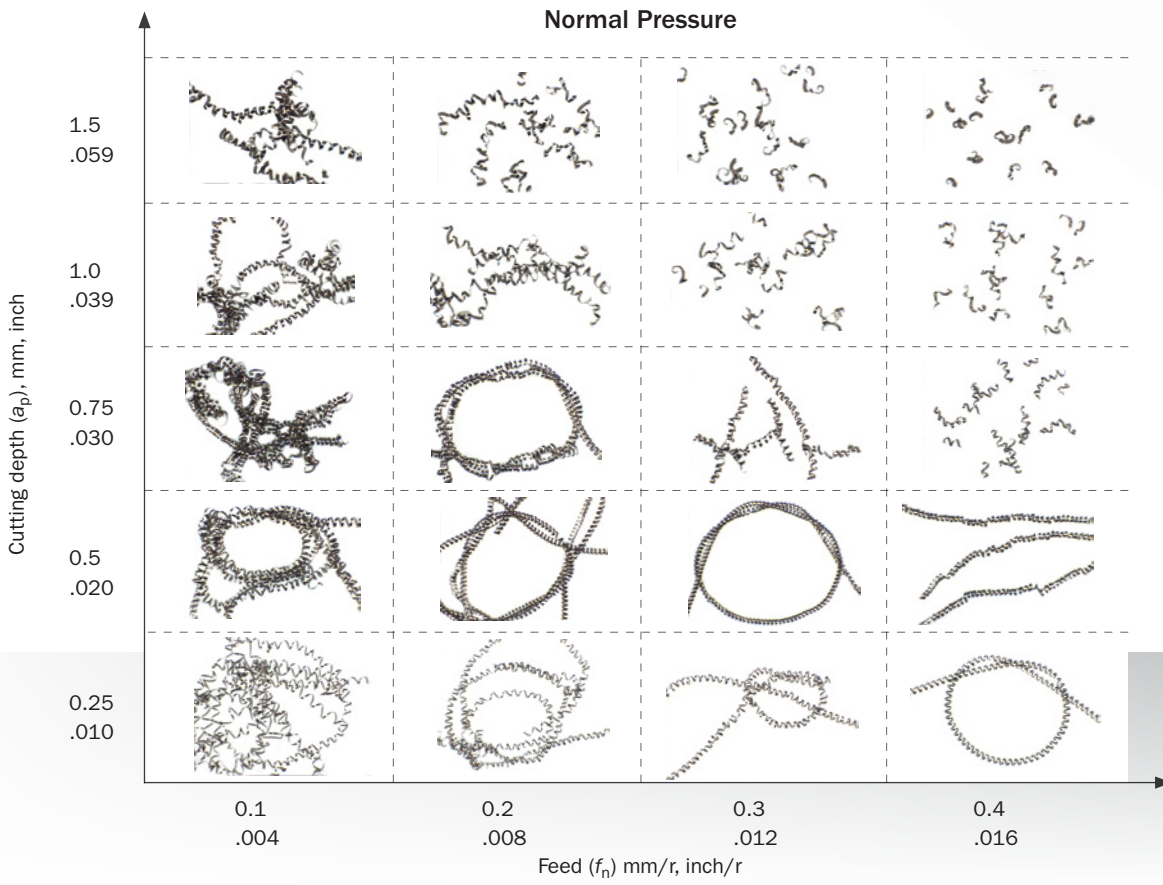

Turning steel/aluminum with HPC

Low alloy steel - case hardening CNMG 120408-PF 4225 - v_c 250 m/min, CNMG 432-PF 4225 - v_c 820 sfm

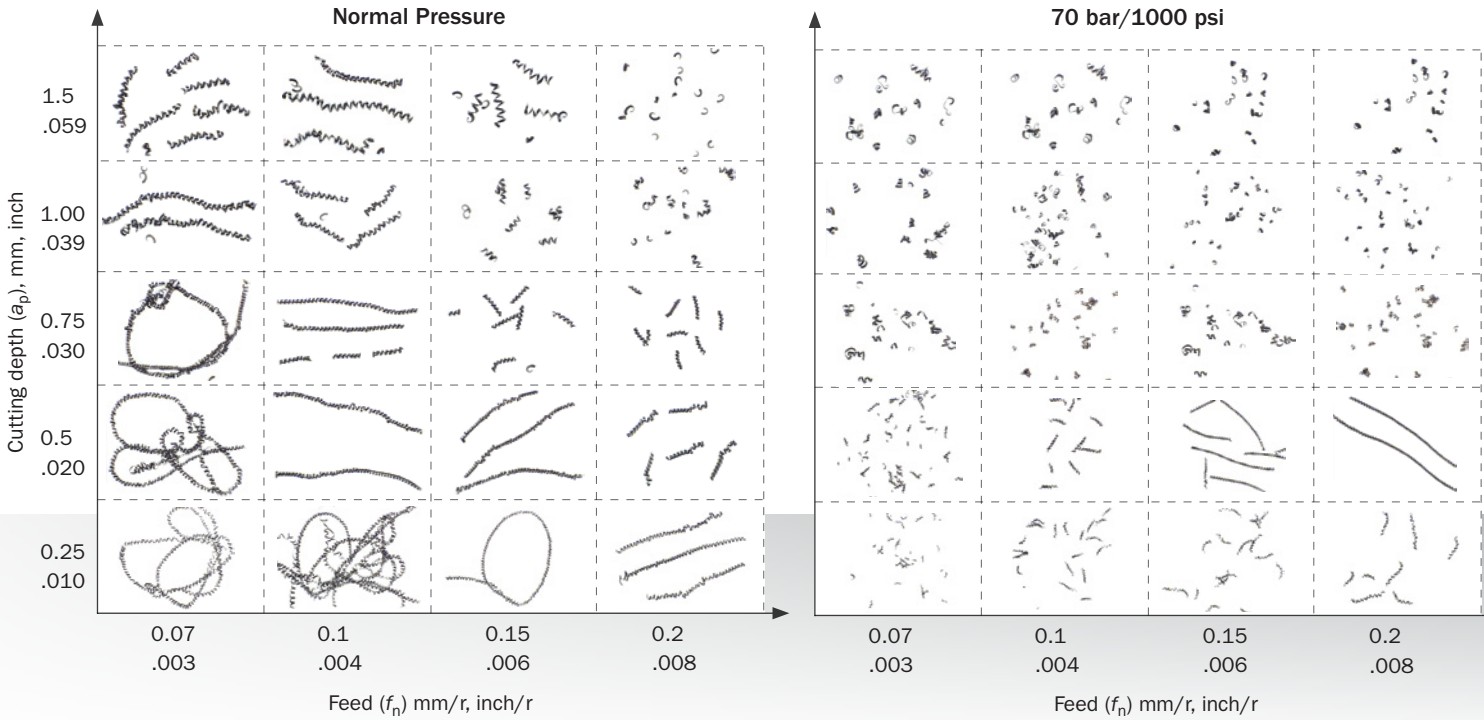

Aluminum - Alumecc CNGP 120408 H13A - v_c 200 m/min, CNGP 432 H13A - v_c 650 sfm

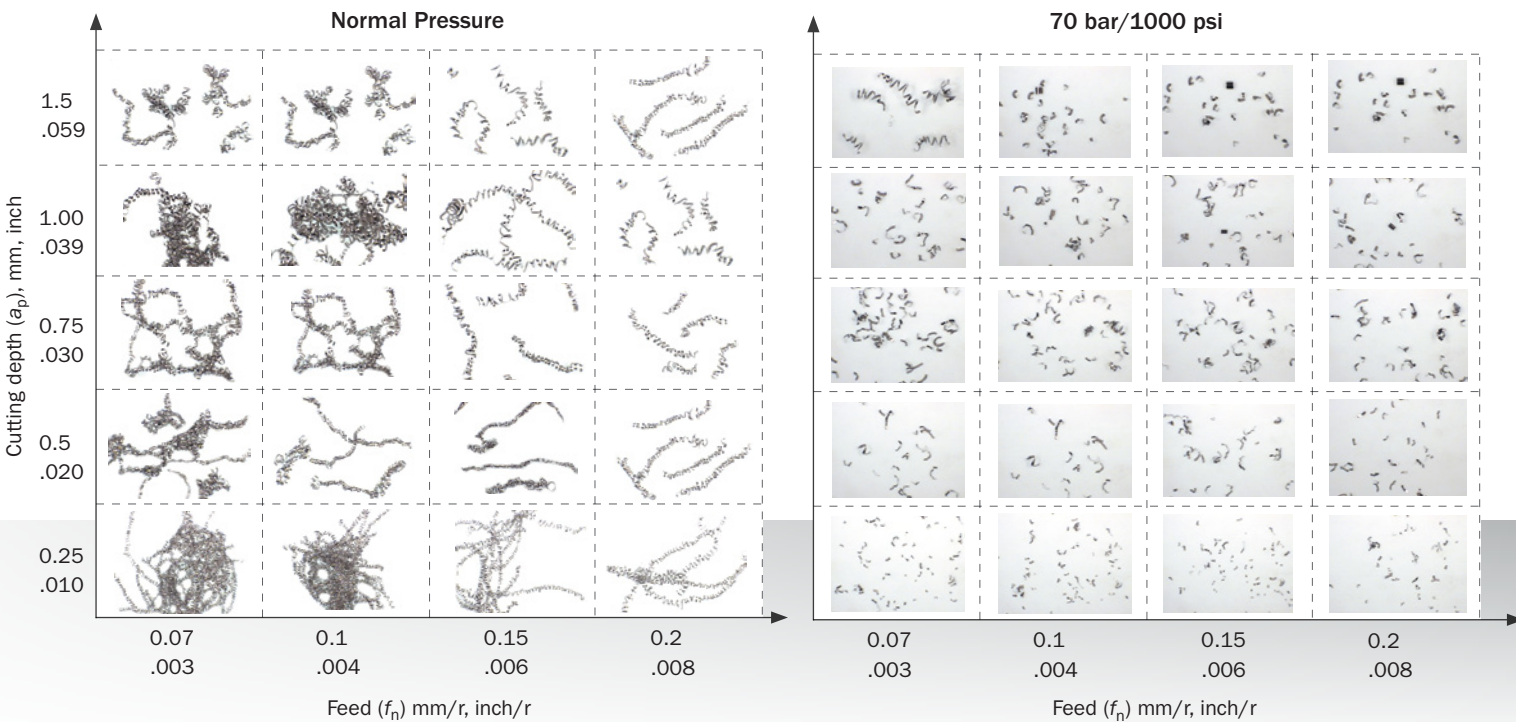

Pioneering that paved the way

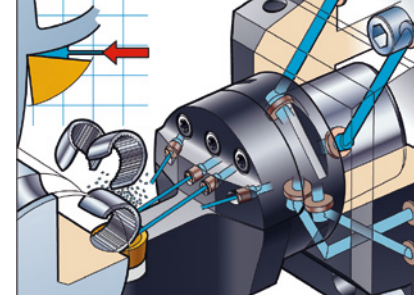

During the 1980s and 90s, Sandvik Coromant developed high pressure machining which resulted in Jetbreak, an ultra-high pressure coolant system. Based on research, precisely directed jets of coolant at very high pressure of up to 1000 bar, as part of the cutting tool, can be used advantageously to machine materials, such as superalloys, titanium and stainless steels, that are demanding, both with regard to machinability and troublesome chips.

It was found that the coolant jets forced their way in, forming a fluid wedge between the chip and rake face of the tool. The contact length between chip and tool was shortened with a lowering of the temperature at the machining zone. Another interesting result was how the curl and cooling of chips was influenced, improving the control of the chip and the chipbreaking.

Ultra-high pressure coolant application, in the form of Jetbreak, became the solution for a limited number of special tool operations, particularly for turning titanium and heat resistant super-alloys but also stainless steel and low-carbon steels – all known for their poor machinability and/or troublesome chips. A lot was learned about the effect of coolant-pressure distribution and coolant-nozzle size.

By varying the jet data, a variable chip-former was achieved and it became possible to guide the stringy chips in a desired direction and even control the length of chips. Installations were made on a limited scale to solve problems particularly in the oil, aerospace and ball bearing industries. Modern concepts in turning, milling and drilling with high pressure coolant (HPC) – now made more easily available - are based on the R&D and experience gained through several years of applications.

Today's state-of-the-art in milling with HPC

Titanium machining is dependent on coolant being applied – the more qualified, the better the machining result. High pressure coolant application at around 1160 psi (80 bar) pressure has proved to provide clear advantages for milling. Consequently, as pressure-coolant is a standard feature on many of today's machines, it is a potential resource to optimize especially the many radial milling operations on titanium components.

Dedicated to titanium milling, CoroMill 690 is an advanced long-edge milling cutter that has coolant channels and outlets for providing high pressure coolant machining for each insert. With several inserts making up each radial edge, coolant nozzles can be positioned to provide the benefits of high pressure jets adapted for milling titanium. In cases where the whole axial depth capability of the cutter is not used, plugs can be used instead of nozzles, in that way avoiding wasted coolant pressure through unnecessary jets.

As coolant is always part of titanium machining, high pressure coolant application is a proven boost for performance, security and results. The volume of coolant is a factor when it comes to delivering sufficient supply to provide high pressure jets for the numerous holes on a long-edge cutter. A calculation of flow and pressure can therefore solve the question of nozzles at selected holes based on machine, cutting data, axial cutting depth and tool specifics.



Coromant Capto® – the basis for tooling



Coromant Capto is both a machine tool interface and a modular tool holding system. It is one system that forms an equally good solution for most types of machining operations, external and internal, for entire machine shops. As an established ISO-standard it is available as a standard or option on most CNC-machinery, with stationary and/or rotating tools.

The Coromant Capto system has the advantage of having the high pressure coolant facility already installed. The plumbing has been prepared and it is therefore only a matter of connecting the tooling elements together in the normal way. The fixed-nozzle concept of CoroTurn HP then ensures that the coolant jet is accurately directed where it is most needed.

The total Coromant Capto range includes six different sizes, C3 to C10, with a wide-ranging program of basic holders, tool holders, integrated cutting tools, adapters and chucks. CoroTurn HP is covered by C4, C5, C6 and C8 as well as Coromant Capto to CoroTurn SL modular blade system.

Coromant Capto - thanks to its coupling - is unique with regard to the combination of properties:

- high torque transmission
- high bending strength
- balanced and concentric
- high basic stability and accuracy
- flexible with extensive modularity
- quick-change and automated tool change
- and, vital for machining with high pressure coolant: through-tool delivery of coolant, from machine to cutting edge. Coromant Capto is as such the basis for CoroTurn HP

Coromant Capto fulfills the needs of a tooling system in all machine types. In lathes and turning centers as a quick-change, modular tooling system. In multi-task machines and machining centers as a rotating-spindle interface and as modular tooling.

The majority of machine tool manufacturers have Coromant Capto as a standard or option as part of the tooling setup and rotating spindle interface. Sandvik Coromant has a range of standard static- and driven-tool machine-adapted clamping units for the majority of leading brand lathes.



High pressure coolant - assortment

CoroTurn® HP cutting units

T-Max P lever design

With high pressure coolant



- CNMM, CNGP
- CNMG
- CNMA, CNGA

Entering angle:
Lead angle

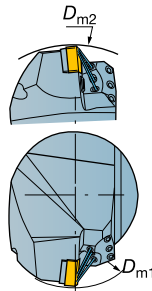

Cx-PCLNR/L-HP

κ_r 95°
-5°

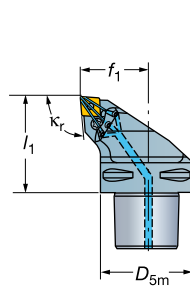

Cx-PCNR/L-HP

κ_r 75°
15°

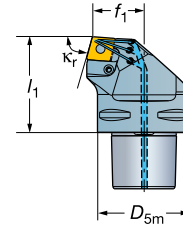

Right hand style shown

Main application	\square	iC	Ordering code	Dimensions, mm, inch							ρ kg	Gauge inserts		
				D_{5m}	D_{m1} min ⁴⁾	D_{m2} min ⁴⁾	f_1	h	$\gamma^1)$	$\lambda_s^2)$		ISO	ANSI	Nm ³⁾
	12	1/2	C4-PCLNR/L-27050-12HP	40	110	140	27	50	-6°	-6°	0.4	CNMG 12 04 08	CNMG 432	5.0
			C5-PCLNR/L-35060-12HP	50	110	165	35	60	-6°	-6°	0.8	CNMG 12 04 08	CNMG 432	5.0
			C6-PCLNR/L-45065-12HP	63	110	195	45	65	-6°	-6°	1.2	CNMG 12 04 08	CNMG 432	5.0
			C8-PCLNR/L-55080-12HP	80	110	250	55	80	-6°	-6°	2.5	CNMG 12 04 08	CNMG 432	5.0
	16	5/8	C5-PCLNR/L-35060-16HP	50	125	165	35	60	-6°	-6°	0.8	CNMG 16 06 12	CNMG 543	5.0
			C6-PCLNR/L-45065-16HP	63	110	195	45	65	-6°	-6°	1.2	CNMG 16 06 12	CNMG 543	5.0
			C8-PCLNR/L-55080-16HP	80	125	250	55	80	-6°	-6°	2.5	CNMG 16 06 12	CNMG 543	5.0
			C6-PCLNR/L-45065-19HP	63	110	195	45	65	-6°	-6°	1.2	CNMG 19 06 12	CNMG 643	10.0
19	3/4	C8-PCLNR/L-55080-19HP	80	150	250	55	80	-6°	-6°	2.5	CNMG 19 06 12	CNMG 643	10.0	
		C6-PCNR/L-35065-16HP	63	190	35	65	-6°	-6°	1.4	CNMG 16 06 12	CNMG 543	5.0		
	16	5/8	C6-PCNR/L-35065-19HP	63	190	35	65	-6°	-6°	1.3	CNMG 19 06 12	CNMG 643	10.0	
				2.480	7.480	1.378	2.559	-6°	-6°					

1) γ = Rake angle (valid with flat insert).

2) λ = Angle of inclination

3) Insert tightening torque, ft-lbs (Nm).

4) Valid in combination with clamping unit R/LC2090.

R = Right hand, L = Left hand

Main spare parts

Insert size		Lever	Screw	Key (mm)	Shim	Nozzle (hole dia.)
\square	iC					
12	1/2	174.3-841M	174.3-821	174.1-864 (3.0)	171.31-850M	5691 026-03 (1.0)
16	5/8	438.3-840	438.3-831	174.1-864 (3.0)	171.31-852	5691 026-03 (1.0)
19	3/4	174.3-842M	174.3-822M	3021 010-040 (4.0)	171.31-851M	5691 026-03 (1.0)

CoroTurn® HP cutting units

Lever design

With high pressure coolant



- CNMM, CNGP
- CNMG
- CNMA, CNGA

Entering angle:
Lead angle

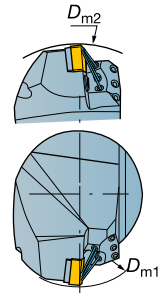

Cx-PCLNR/L-HP
 $\kappa_r 95^\circ$
 -5°

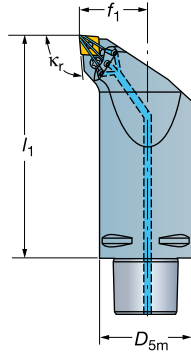

Cx-PCMNN-HP
 $\kappa_r 50^\circ (95^\circ)$
 -5°

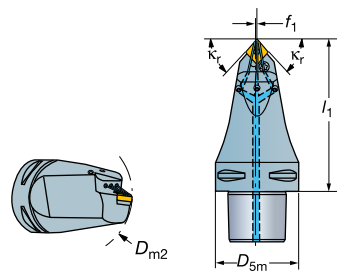

Neutral

Right hand style shown

Main application		iC	Ordering code	Dimensions, mm, inch							Gauge insert		
				D_{sm}	D_{m1} min ⁴⁾	f_1	l_1	$\gamma^1)$	$\lambda_s^2)$		ISO	ANSI	Nm ³⁾
	12	1/2	C6-PCLNR/L-45165-12HP	63	110	45.0	165	-6°	-6°	3.50	CNMG 12 04 08	CNMG 432	5.0
				2.480	4.331	1.772	6.496	-6°	-6°				

Main application		iC	Ordering code	Dimensions, mm, inch							Gauge insert		
				D_{sm}	D_{m2} min ⁴⁾	f_1	l_1	$\gamma^1)$	$\lambda_s^2)$		ISO	ANSI	Nm ³⁾
	12	1/2	C6-PCMNN-00115-12HP	63	110	0.0	115	-6°	-6°	1.84	CNMG 12 04 08	CNMG 432	5.0
				2.480	4.331	.000	4.528	-6°	-6°				
	12	1/2	C8-PCMNN-00150-12HP	80	315	0.0	150	-6°	-6°	3.80	CNMG 12 04 08	CNMG 432	5.0
				3.150	12.402	.000	5.906	-6°	-6°				

1) γ = Rake angle (valid with flat insert).

2) λ_s = Angle of inclination.

3) Insert tightening torque, ft-lbs (Nm).

4) Valid in combination with clamping unit R/LC2090.

N = Neutral, R = Right hand, L = Left hand

Main spare parts

Insert size		Main spare parts				
	iC	Lever	Screw	Key (mm)	Shim	Nozzle (hole dia mm.)
12	1/2	174.3-841M	174.3-821	174.1-864 (3.0)	171.31-850M	5691 026-03 (1.0)

CoroTurn® HP cutting units

T-Max P lever design

With high pressure coolant

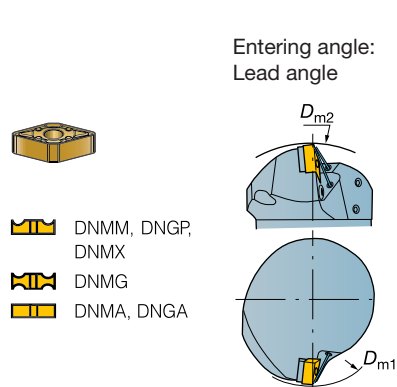

Cx-PDJNR/L-15HP
 $\kappa_r 93^\circ$
 -3°

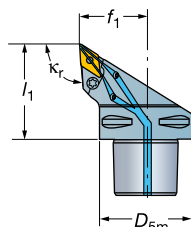

Cx-PDMNR/L-15HP
 $\kappa_r 48^\circ (93^\circ)$
 $42^\circ (-3^\circ)$

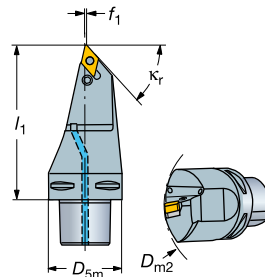

Right hand style shown

Main application		iC	Ordering code	Dimensions, mm, inch							Gauge inserts			
				D_{sm}	D_{m1} min ⁴⁾	D_{m2} min ⁴⁾	f_1	h_1	$\gamma^1)$	$\lambda_s^2)$	$\frac{R}{kg}$	ISO	ANSI	Nm ³⁾
	15	1/2	C4-PDJNR/L-27055-15HP	40	65	145	27	55	-6°	-7°	0.4	DNMG 15 06 08	DNMG 442	5.0
			C5-PDJNR/L-35060-15HP	50	65	165	35	60	-6°	-7°	0.7	DNMG 15 06 08	DNMG 442	5.0
			C5-PDJNR-35060-1504HP	50	70	165	35	60	-6°	-7°		DNMG 15 04 08	DNMG 432	5.0
			C6-PDJNR/L-45065-1504HP	63	95	195	45	65	-6°	-7°	1.2	DNMG 15 04 08	DNMG 432	5.0
			C6-PDJNR/L-45065-15HP	63	95	195	45	65	-6°	-7°		DNMG 15 06 08	DNMG 442	5.0
			C8-PDJNR/L-55080-15HP	80	130	250	55	80	-6°	-7°	4.3	DNMG 15 06 08	DNMG 442	5.0
			C8-PDJNR/L-55080-1504HP	80	130	250	55	80	-6°	-7°		DNMG 15 04 08	DNMG 432	5.0
				3.150	5.118	9.842	2.165	3.150	-6°	-7°				

Main application		iC	Ordering code	Dimensions, mm, inch				Gauge insert			
				D_{sm}	f_1	h_1	$\gamma^1)$	$\lambda_s^2)$	ISO	ANSI	Nm ³⁾
	15	1/2	C6-PDMNR/L-00130-15HP	63	0.6	130	-5°	-15°	DNMG 15 06 08	DNMG 442	5.0
				2.480	.022	5.118	-5°	-15°			

1) γ = Rake angle (valid with flat insert).

2) λ_s = Angle of inclination.

3) Insert tightening torque, ft-lbs (Nm).

4) Valid in combination with clamping unit R/LC2090.

R = Right hand, L = Left hand

Main spare parts

Insert size		Coromant Capto® size					
	iC	Lever	Screw	Key (mm)	Shim	Nozzle (hole dia mm.)	
15 06	1/2 (DNMG 44)	C4-C8	174.3-847M	174.3-830	174.1-864 (3.0)	171.35-851M	5691 026-03 (1.0)
15 04	1/2 (DNMG 43)	C5	174.3-847M	174.3-830	174.1-864 (3.0)	171.35-856	5691 026-03 (1.0)
15 04	1/2 (DNMG 43)	C6-C8	174.3-847M	174.3-830	174.1-864 (3.0)	171.35-851M	5691 026-03 (1.0)

CoroTurn® HP cutting units

Lever design



With high pressure coolant

Cx-PDJNR/L-HP

κ_r 93°
-3°



Entering angle:
Lead angle

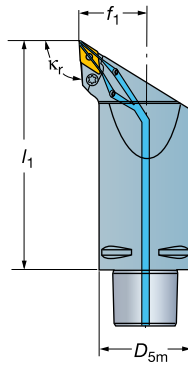
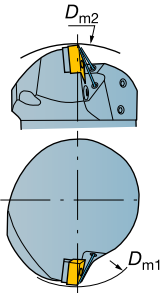

-  DNMM, DNGP, DNMX
-  DNMG
-  DNMA, DNGA

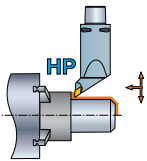

Right hand style shown

Main application		iC	Ordering code	Dimensions, mm, inch							Gauge insert			
				D_{5m}	D_{m1} min ⁴⁾	D_{m2} min ⁴⁾	f_1	h	$\gamma^1)$	$\lambda_s^2)$	 kg	ISO	ANSI	Nm ³⁾
	15	1/2	C6-PDJNR/L-45165-15HP	63	95	290	45.0	165	-6°	-7°	3.52	DNMG 15 06 08	DNMG 442	5.0
				2.480	3.740	11.417	1.772	6.496	-6°	-7°				

1) γ = Rake angle (valid with flat insert).

2) λ_s = Angle of inclination.

3) Insert tightening torque, ft-lbs (Nm).

4) Valid in combination with clamping unit R/LC2090.

R = Right hand, L = Left hand

Main spare parts

Insert size		Lever	Screw	Key (mm)	Shim	Nozzle (hole dia mm.)
	iC					
15	1/2	174.3-847M	174.3-830	174.1-864 (3.0)	171.35-851M	5691 026-03 (1.0)

CoroTurn® HP cutting units

T-Max P lever design

With high pressure coolant

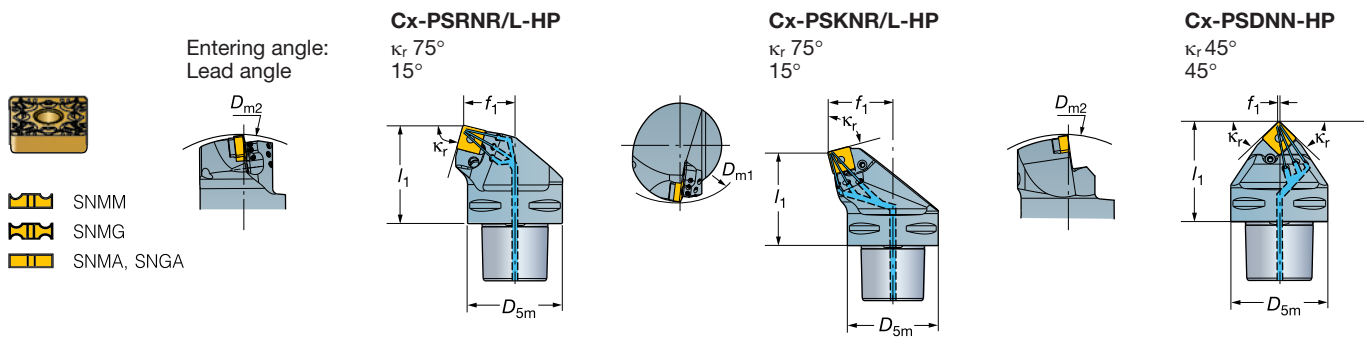

Right hand style shown

Main application	□ iC	iC	Ordering code	Dimensions, mm, inch								Gauge inserts		
				D _{5m}	D _{m1} min ⁴⁾	D _{m2} min ⁴⁾	f ₁	h ₁	γ ¹⁾	λ _s ²⁾	κ _{IC}	ISO	ANSI	Nm ³⁾
	15	5/8	C6-PSRNR/L-35065-15HP	63	190	35	65	-6°	-6°	1.3	SNMG 15 06 12	SNMG 543	3.7	
			2.480	7.480	1.378	2.559	-6°	-6°						
			19	3/4	C6-PSRNR/L-35065-19HP	63	190	35	65	-6°	-6°	1.3	SNMG 19 06 12	SNMG 643
			C8-PSRNR/L-45080-19HP	80	250	45	80	-6°	-6°	2.7	SNMG 19 06 12	SNMG 643	8.8	
			3.150	9.842	1.772	3.150	-6°	-6°						
	15	5/8	C6-PSKNR/L-45065-15HP	63	125	45	65	-6°	-6°	1.4	SNMG 15 06 12	SNMG 543	5.0	
			2.480	4.921	1.772	2.559	-6°	-6°						
			19	3/4	C6-PSKNR/L-45065-19HP	63	125	45	65	-6°	-6°	1.5	SNMG 19 06 12	SNMG 643
			C8-PSKNR/L-55080-19HP	80	125	55	80	-6°	-6°	2.8	SNMG 19 06 12	SNMG 643	10.0	
			3.150	4.921	2.165	3.150	-6°	-6°						
	15	5/8	C6-PSDNN-00065-15HP	63	190	0.5	65	-6°	-6°	1.1	SNMG 15 06 12	SNMG 543	5.0	
			2.480	7.480	.020	2.559	-6°	-6°						
			19	3/4	C6-PSDNN-00065-19HP	63	190	0.5	65	-6°	-6°	1.2	SNMG 19 06 12	SNMG 643
			2.480	7.480	.020	2.559	-6°	-6°						

1) γ = Rake angle (valid with flat insert).

2) λ = Angle of inclination

3) Insert tightening torque, ft-lbs (Nm).

4) Valid in combination with clamping unit R/LC2090.

N = Neutral, R = Right hand, L = Left hand

Main spare parts

Insert size						
□ iC	iC	Lever	Screw	Key (mm)	Shim	Nozzle (hole dia.)
15	5/8	438.3-840	438.3-831	174.1-864 (3.0)	174.3-857	5691 026-03 (1.0)
19	3/4	174.3-842M	174.3-822M	3021 010-040 (4.0)	174.3-852M	5691 026-03 (1.0)

CoroTurn® HP cutting units

T-Max P lever design

With high pressure coolant



- SNMM
- SNMG
- SNMA, SNGA

Entering angle:
Lead angle

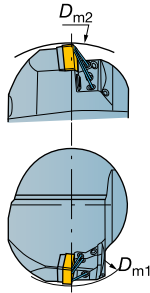

Cx-PSSNR/L-HP

κ_r 45°
45°

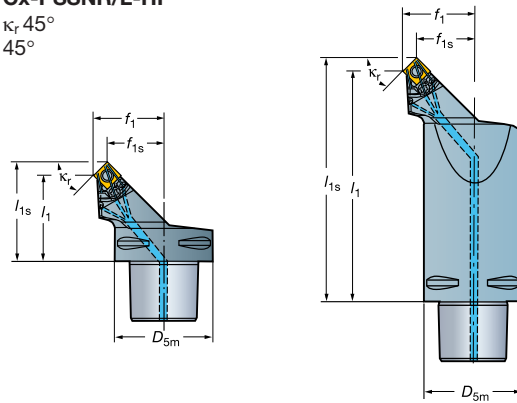

Right hand style shown

Main application	□	iC	Ordering code	Dimensions, mm, inch										Gauge insert		Nm ³⁾
				D _{5m}	D _{m1} min ⁴⁾	D _{m2} min ⁴⁾	f ₁	f _{1s}	h ₁	h _{1s}	γ ¹⁾	λ _s ²⁾	⊖ mm	ISO	ANSI	
	12	1/2	C5-PSSNR/L-35052-12HP	50	110	165	35.0	26.9	52	60.3	-8°	0°	0.70	SNMG 12 04 08	SNMG 432	5.0
			C6-PSSNR/L-45056-12HP	63	110	200	45.0	36.7	56	64.3	-8°	0°	1.05	SNMG 12 04 08	SNMG 432	5.0
			C8-PSSNR/L-55080-12HP	80	200	260	55.0	46.7	80	88.3	-8°	0°	2.40	SNMG 12 04 08	SNMG 432	5.0
				2.480	4.331	7.874	1.772	1.445	2.205	2.532	-8°	0°				
	15	5/8	C5-PSSNR/L-35050-15HP	50	110	165	35.0	25.5	50	60.2	-8°	0°	0.70	SNMG 15 06 12	SNMG 543	5.0
			C6-PSSNR/L-45054-15HP	63	110	200	45.0	34.8	54	64.2	-8°	0°	1.10	SNMG 15 06 12	SNMG 543	5.0
				2.480	4.331	7.874	1.772	1.370	2.126	2.528	-8°	0°				
			C6-PSSNR/L-45052-19HP	63	110	180	45.0	32.5	52	64.5	-8°	0°	1.07	SNMG 19 06 12	SNMG 643	5.0
19	3/4	C6-PSSNR/L-45052-19HP	63	110	180	45.0	32.5	52	64.5	-8°	0°	1.07	SNMG 19 06 12	SNMG 643	5.0	
		C8-PSSNR/L-55080-19HP	80	200	260	55.0	42.5	80	92.5	-8°	0°	2.55	SNMG 19 06 12	SNMG 643	5.0	
			2.480	4.331	7.087	1.772	1.280	2.047	2.539	-8°	0°					
			3.150	7.874	10.236	2.165	1.673	3.150	3.642	-8°	0°					

Right hand style shown

Main application	□	iC	Ordering code	Dimensions, mm, inch										Gauge insert		Nm ³⁾
				D _{5m}	D _{m1} min ⁴⁾	f ₁	f _{1s}	h ₁	h _{1s}	γ ¹⁾	λ _s ²⁾	⊖ mm	ISO	ANSI		
	12	1/2	C6-PSSNR/L-45156-12HP	63	110	45.0	36.7	156	164.3	-8°	0°	3.38	SNMG 12 04 08	SNMG 432	5.0	
				2.480	4.331	1.772	1.445	6.142	6.468	-8°	0°					

1) γ = Rake angle (valid with flat insert).

2) λ_s = Angle of inclination.

3) Insert tightening torque, ft-lbs (Nm).

4) Valid in combination with clamping unit R/LC2090.

R = Right hand, L = Left hand

Main spare parts

Insert size		Lever	Screw	Key (mm)	Shim	Nozzle (hole dia.)
□	iC					
12	1/2	174.3-841M	174.3-821	174.1-864 (3.0)	174.3-851M	5691 026-03 (1.0)
15	5/8	438.3-840	438.3-831	174.1-864 (3.0)	174.3-857	5691 026-03 (1.0)
19	3/4	174.3-842M	174.3-822M	3021 010-040 (4.0)	174.3-852M	5691 026-03 (1.0)

CoroTurn® HP cutting units

CoroTurn 107 – Screw clamp design

With high pressure coolant



RCMT
RCGX-AL

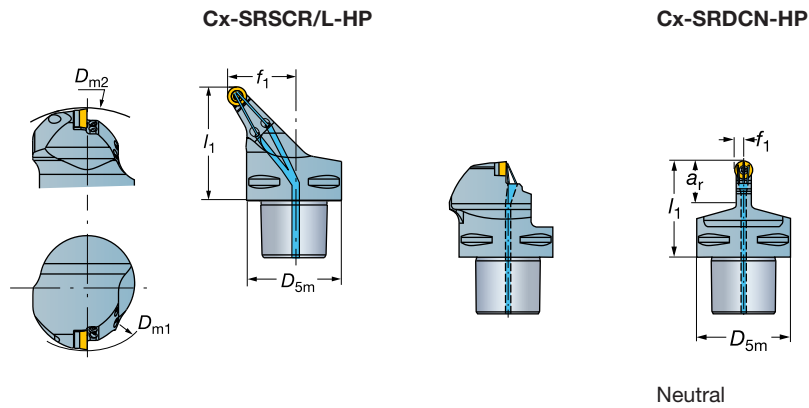

Right hand style shown

Main application	ISO	iC	Ordering code	Dimensions, mm, inch								Gauge insert		
				D _{5m}	D _{m1} min ⁴⁾	D _{m2} min ⁴⁾	f ₁	l ₁	γ ¹⁾	λ _s ²⁾	λ _s	ISO	ANSI	Nm ³⁾
	10	.394	C5-SRSCN-35060-10HP	50	130	270	35.0	60	0°	0°	0.63	RCMT 10 T3 M0	RCMT 10 T3 M0	3.0
			C5-SRSCR-35060-10HP	1.968	5.118	10.630	1.378	2.362	0°	0°	0.63	RCMT 10 T3 M0	RCMT 10 T3 M0	3.0
			C6-SRSCR/L-45065-10HP	63	140	300	45.0	65	0°	0°	1.10	RCMT 10 T3 M0	RCMT 10 T3 M0	3.0
				2.480	5.512	11.811	1.772	2.559	0°	0°				
			C5-SRSCR/L-35060-12HP	50	130	270	35.0	60	0°	0°	0.63	RCMT 12 04 M0	RCMT 12 04 M0	3.0
				1.968	5.118	10.630	1.378	2.362	0°	0°				
	12	.472	C6-SRSCR/L-45065-12HP	63	120	195	45.0	65	0°	0°	1.24	RCMT 12 04 M0	RCMT 12 04 M0	3.0
				2.480	4.724	7.677	1.772	2.559	0°	0°				
			C6-SRDCN-00065-12HP	63	300	200	6.0	65	0°	0°	1.00	RCMT 12 04 M0	RCMT 12 04 M0	3.0
				2.480	11.811	7.874	.236	2.559	0°	0°				

1) γ = Rake angle (valid with flat insert).

2) λ_s = Angle of inclination.

3) Insert tightening torque, ft-lbs (Nm).

4) Valid in combination with clamping unit R/LC2090.

N = Neutral, R = Right hand, L = Left hand

Main spare parts

Insert size		Main spare parts						Nozzle (hole dia.)	
ISO	iC	Insert screw (thread)	Key (Torx Plus)	Shim	Shim screw	Key (mm)			
10	.394	5513 020-01 (M3.5)	5680 049-01 (15IP)	5322 110-01	5512 090-01	5680 049-01 (3.5)	5691 026-03 (1.0)		
12	.472	5513 020-01 (M3.5)	5680 049-01 (15IP)	5322 110-02	5512 090-01	5680 049-01 (3.5)	5691 026-03 (1.0)		

CoroTurn® HP cutting units

CoroTurn 107 – Screw clamp design

With high pressure coolant



VBMT, VBGT
VCGX, VCEX,
VCGT, VCET



VBMW, VCMW

Entering angle:
Lead angle:

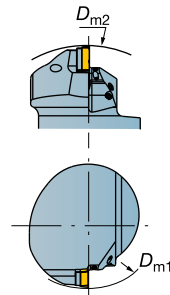

Cx-SVJBR/L-HP

κ_r 93°
-3°

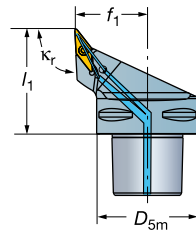

Entering angle:
Lead angle

Cx-SVMBR/L-HP

κ_r 50°
40°

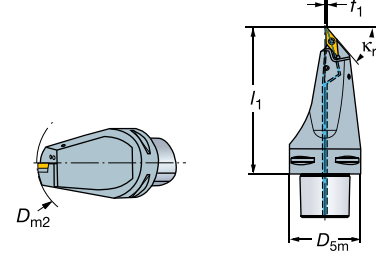

Main application		iC	Ordering code	Dimensions, mm, inch							Gauge insert		Nm ³⁾	
				D _{5m}	D _{m1} min ⁴⁾	D _{m2} min ⁴⁾	f ₁	h ₁	γ ¹⁾	λ _s ²⁾		ISO		ANSI
	16	3/8	C5-SVJBR/L-35060-16HP	50	180	200	35.0	60	0°	0°	0.64	VBMT 16 04 08	VBMT 332	3.0
			C6-SVJBR/L-45065-16HP	63	200	200	45.0	65	0°	0°	1.14	VBMT 16 04 08	VBMT 332	3.0
			C8-SVJBR/L-55080-16HP	80	240	240	55.0	80	0°	0°	2.35	VBMT 16 04 08	VBMT 332	3.0

Right hand style shown

Main application		iC	Ordering code	Dimensions, mm, inch							Gauge insert		Nm ³⁾
				D _{5m}	D _{m2} min ⁴⁾	f ₁	h ₁	γ ¹⁾	λ _s ²⁾		ISO	ANSI	
	16	3/8	C6-SVMBR/L-00130-16HP	63	145	0.0	130	0°	0°	1.84	VBMT 16 04 08	VBMT 332	3.0
				2.480	5.709	.000	5.118	0°	0°				

1) γ = Rake angle (valid with flat insert).

2) λ_s = Angle of inclination.

3) Insert tightening torque, ft-lbs (Nm).

4) Valid in combination with clamping unit R/LC2090.

R = Right hand, L = Left hand

Main spare parts

Insert size		Insert screw (thread)	Key (Torx Plus)	Shim	Shim screw	Key (mm)	Nozzle (hole dia.)
	iC	5513 020-01 (M3.5)	5680 049-01 (15IP)	5322 270-01	5512 090-01	5680 049-01 (3.5)	5691 026-13 (1.0)

SL cutting heads with CoroTurn® HP

T-Max P lever clamp design

With high pressure coolant

Entering angle:
Lead angle:

PCLNR/L-HP

κ_r 95°
-5°

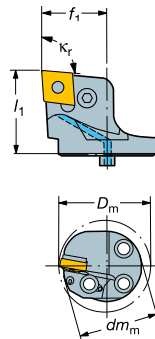

PDUNR/L-HP

κ_r 93°
-3°

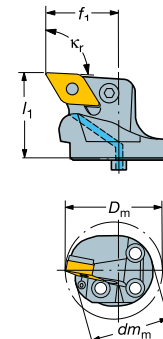

- CNMM, CNGP
- CNMG
- CNMA, CNGA

- DNMM, DNGP, DNMX
- DNMG
- DNMA, DNGA

Right hand style shown

Main application		iC	Ordering code	Dimensions, mm, inch						Gauge insert	
				$dm_m^{4)}$	D_m min	f_1	l_1	$\gamma^1)$	$\lambda_s^2)$	ISO	ANSI
	12	1/2	SL-PCLNR/L-32-12HP	32	40.0	22.0	32	-6°	-10°	CNMG 12 04 08	CNMG 432
			SL-PCLNR/L-40-12HP	40	50.0	27.0	35	-6°	-10°	CNMG 12 04 08	CNMG 432
	16	5/8	SL-PCLNR/L-40-16HP	40	56.0	27.0	42	-6°	-10°	CNMG 16 06 08	CNMG 542
				1.575	2.205	1.063	1.654	-6°	-10°		

Main application		iC	Ordering code	Dimensions, mm, inch						Gauge insert	
				$dm_m^{4)}$	D_m min	f_1	l_1	$\gamma^1)$	$\lambda_s^2)$	ISO	ANSI
	11	3/8	SL-PDUNR/L-32-11HP	32	40.0	22.0	32	-6°	-10°	DNMG 11 04 08	DNMG 332
			SL-PDUNR/L-40-15HP	40	56.0	30.0	36	-6°	-11°	DNMG 15 06 08	DNMG 442
				1.575	2.205	1.181	1.417	-6°	-11°		

1) γ = Rake angle (valid with flat insert).

2) λ_s = Angle of inclination.

4) Coupling size, mm

R = Right hand, L = Left hand

Main spare parts

Insert size						Lever	Screw	Key (mm)	Shim	Nozzle (hole dia.)	Locating tube
CNM.			DNM.								
	iC	Bar dia.		iC	Bar dia.						
12	1/2	32				174.3-848M	174.3-858	174.1-864 (3.0)	171.31-850M	5691 026-03 (1.0)	5638 031-01
12	1/2	40				174.3-841M	174.3-821	174.1-864 (3.0)	171.31-850M	5691 026-03 (1.0)	5638 031-01
16	5/8	40				438.3-840	438.8-831	174.1-864 (3.0)	171.31-852	5691 026-03 (1.0)	5638 031-01
			11	3/8	1.260	5432 001-01	174.3-820M	174.1-863 (2.5)	5322 255-01	5691 026-03 (1.0)	5638 031-01
			15	1/2	1.575	174.3-847M	174.3-830	174.1-864 (3.0)	171.35-851M	5691 026-03 (1.0)	5638 031-01

SL cutting heads with CoroTurn® HP

T-Max P lever clamping

With high pressure coolant



- TNMM, TNMX
- TNMG
- TNMA, TNGA

Entering angle:
Lead angle:

PTFNR/L-HP

κ_r 91°
-1°

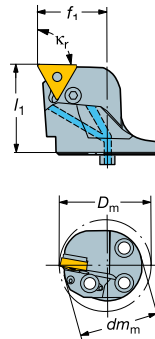

Right hand style shown when nothing else is stated

Main application		iC	Ordering code	Dimensions, mm, inch						Gauge insert	
				$dm_m^{4)}$	D_m min	f_1	h_1	$\gamma^1)$	$\lambda_s^{2)}$	ISO	ANSI
	16	3/8	SL-PTFNR/L-32-16HP	32	40.0	22.0	35	-6°	-8°	TNMG 16 04 08	TNMG 332
				1.260	1.575	.866	1.378	-6°	-8°		
			SL-PTFNR/L-40-16HP	40	50.0	27.0	35	-6°	-10°	TNMG 16 04 08	TNMG 332
				1.575	1.968	1.063	1.378	-6°	-10°		

1) γ = Rake angle (valid with flat insert).

2) λ_s = Angle of inclination.

4) Coupling size, mm

R = Right hand, L = Left hand

Main spare parts

Insert size		Lever	Screw	Key (mm)	Shim	Nozzle (hole dia.)	Locating tube
	iC	174.3-840M	174.3-820M	170.3-860 (2.5)	179.3-850M	5691 026-03 (1.0)	5638 031-01

SL cutting heads with CoroTurn® HP

T-Max P lever clamp design

For external turning

With high pressure coolant

PDJNR/L-HP

Entering angle:

κ_r 93°

Lead angle:

-3°



- DNMM, DNGP, DNMX
- DNMG
- DNMA, DNGA

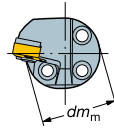
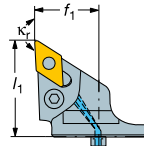

Right hand style shown

Main application	□ iC	iC	Ordering code	Dimensions, mm, inch					Gauge insert		Nm ³⁾
				dm ⁴⁾	f ₁	l ₁	γ ¹⁾	λ _s ²⁾	ISO	ANSI	
	15	1/2	SL-PDJNR/L-32-15HP	32	27.0	40	-6°	-7°	DNMG 15 06 08	DNMG 442	3.9
				1.260	1.063	1.575	-6°	-7°			
			SL-PDJNR/L-40-15HP	40	27.0	40	-6°	-7°	DNMG 15 06 08	DNMG 442	3.9
				1.575	1.063	1.575	-6°	-7°			

1) γ = Rake angle (valid with flat insert).

R = Right hand, L = Left hand

2) λ_s = Angle of inclination.

3) Insert tightening torque, ft-lbs (Nm).

4) Coupling size, mm

Main spare parts

Insert size		Coupling size, mm	Lever	Screw	Key (mm)	Shim	Nozzle (hole dia.)	Shim pin	Shim pin punch	Locating tube
□ iC	iC									
15	1/2	32-40	174.3-847M	174.3-830	174.1-864 (3.0)	171.35-851M	5691 026-03 (1 mm)	174.3-861	174.3-871	5638 031-01

SL cutting heads with CoroTurn® HP

T-Max P lever clamp design

For external turning

With high pressure coolant

Entering angle:
Lead angle:

PSSNR/L-HP-X
 κ_r 45°
45°

PSRNR/L-HP
 κ_r 75°
15°



- SNMM
- SNMG
- SNMA, SNGA

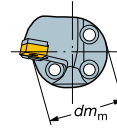
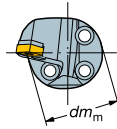
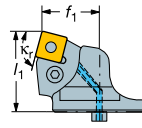
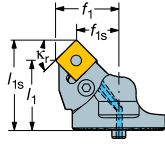

Right hand style shown

Main application	□ 12	iC 1/2	Ordering code	Dimensions, mm, inch					Gauge insert		Nm ³⁾
				$dm_m^{4)}$	f_1	l_1	$\gamma^{1)}$	$\lambda_s^{2)}$	ISO	ANSI	
			SL-PSSNR/L-40-12HP-X	40	27.0	30	-8°	0°	SNMG 12 04 08	SNMG 432	3.9
				1.575	1.063	1.181	-8°	0°			

Main application	□ 12	iC 1/2	Ordering code	Dimensions, mm, inch					Gauge insert		Nm ³⁾
				$dm_m^{4)}$	f_1	l_1	$\gamma^{1)}$	$\lambda_s^{2)}$	ISO	ANSI	
			SL-PSRNR/L-40-12HP	40	22.0	35	-6°	-6°	SNMG 12 04 08	SNMG 432	3.9
				1.575	.866	1.378	-6°	-6°			

- 1) γ = Rake angle (valid with flat insert).
- 2) λ_s = Angle of inclination.
- 3) Insert tightening torque, ft-lbs (Nm).
- 4) Coupling size, mm

R = Right hand, L = Left hand

Main spare parts

Insert size		Coupling size, mm	Lever	Screw	Key (mm)	Shim	Nozzle (hole dia.)	Shim pin	Shim pin punch	Locating tube
□ 12	iC 1/2									
12	1/2	40	174.3-841M	174.3-821	174.1-864 (3.0)	174.3-851M	5691 026-03 (1.0)	174.3-861	174.3-871	5638 031-01

SL cutting heads with CoroTurn® HP

CoroTurn® TR screw clamp design

With high pressure coolant

Entering angle:
Lead angle:

TR-SL-D13UCR/L

κ_r 93°
-3°



TR-DC

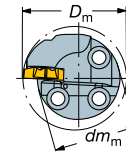
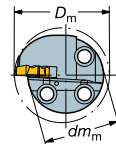
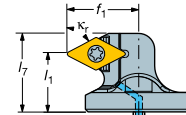
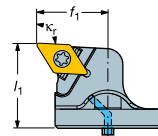

Right hand style shown when nothing else is stated

Main application	13	Ordering code	Dimensions, mm, inch					Gauge insert		
			$dm_m^{(4)}$	f_1	h_1	$\gamma^{(1)}$	$\lambda_s^{(2)}$	ISO	ANSI	Nm ⁽³⁾
		TR-SL-D13UCR/L-32HP	32	22.0	38	0°	-5°	TR-DC1308	TR-DC1308	3.0
		TR-SL-D13UCR/L-40HP	40	27.0	38	0°	-3°	TR-DC1308	TR-DC1308	3.0
			1.260	.866	1.496	0°	-5°			
			1.575	1.063	1.496	0°	-3°			

Right hand style shown when nothing else is stated

Main application	13	Ordering code	Dimensions, mm, inch							Gauge inserts		
			$dm_m^{(4)}$	D_m min	f_1	h_1	h_2	$\gamma^{(1)}$	$\lambda_s^{(2)}$	ISO	ANSI	Nm ⁽³⁾
		TR-SL-D13XCR-32HP	32	45.0	27.0	27.0	34.0	0°	-5°	TR-DC1308	TR-DC1308	3.0
		TR-SL-D13XCR-40HP	40	50.0	29.0	22.0	29.5	0°	-3°	TR-DC1308	TR-DC1308	3.0
			1.260	1.772	1.063	1.063	1.339	0°	-5°			
			1.575	1.968	1.142	.866	1.161	0°	-3°			

1) γ = Rake angle (valid with flat insert).

2) λ_s = Angle of inclination.

3) Insert tightening torque, ft-lbs (Nm).

4) Coupling size, mm

R = Right hand, L = Left hand

Main spare parts

Insert size	Insert screw	Key (Torx Plus/mm)	Torque wrench ¹⁾	Nozzle (hole dia.)	Locating tube
13	5513 020-01	5680 049-01 (15IP)	5680 100-06	5691 026-03 (1.0)	5638 031-01

1) Accessories, must be ordered separately.

SL cutting heads with CoroTurn® HP

CoroTurn® TR screw clamp design

With high pressure coolant



TR-VB

Entering angle:
Lead angle:

TR-SL-V13LBR/L-HP

κ_r 95°
-5°

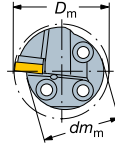
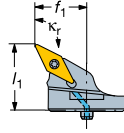

Right hand style shown when nothing else is stated

Main application	13	Ordering code	Dimensions, mm, inch					Gauge insert		Nm ³⁾
			$dm_m^{4)}$	f_1	l_1	$\gamma^{1)}$	$\lambda_s^{2)}$	ISO	ANSI	
 $\leq 45^\circ$ HP		TR-SL-V13LBR/L-32HP	32	22.0	40	0°	-5°	TR-VB1308	TR-VB1308	2.0
			1.260	.866	1.575	0°	-5°			
		TR-SL-V13LBR/L-40HP	40	27.0	38	0°	-4°	TR-VB1308	TR-VB1308	2.0
			1.575	1.063	1.496	0°	-4°			

¹⁾ γ = Rake angle (valid with flat insert).

²⁾ λ_s = Angle of inclination.

³⁾ Insert tightening torque, ft-lbs (Nm).

⁴⁾ Coupling size, mm

R = Right hand, L = Left hand

Main spare parts

Insert size	Insert screw	Key (Torx Plus/mm)	Torque wrench ¹⁾	Nozzle (hole dia.)	Locating tube
13	5513 020-64	5680 049-04 (10IP)	5680 100-05	5691 026-03 (1.0)	5638 031-01

¹⁾ Accessories, must be ordered separately.

SL cutting heads with CoroTurn® HP

For external turning
 CoroTurn® TR screw clamp design
 With high pressure coolant

Entering angle:
 Lead angle:

TR-SL-D13JCR/L-HP-X

κ_r 93°
 -3°



TR-DC

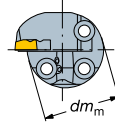
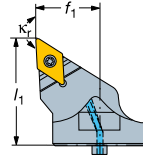

Right hand style shown when nothing else is stated

Main application	Insert size	Ordering code	Dimensions, mm, inch					Gauge insert		Nm ³⁾
			dm_m ⁴⁾	f_1	l_1	γ ¹⁾	λ_s ²⁾	ISO	ANSI	
	13	TR-SL-D13JCR/L-32HP-X	32	22.0	40	0°	0°	TR-DC1308	TR-DC1308	3.0
		TR-SL-D13JCR/L-40HP-X	40	27.0	45	0°	0°	TR-DC1308	TR-DC1308	3.0
			1.260	.866	1.575	0°	0°			
			1.575	1.063	1.772	0°	0°			

- 1) γ = Rake angle (valid with flat insert).
- 2) λ_s = Angle of inclination.
- 3) Insert tightening torque, ft-lbs (Nm).
- 4) Coupling size, mm

R = Right hand, L = Left hand

Main spare parts

Insert size	Insert screw	Key (Torx Plus/mm)	Torque wrench ¹⁾	Nozzle (hole dia.)	Locating tube
13	5513 020-01	5680 049-01 (15IP)	5680 100-06	5691 026-03 (1.0)	5638 031-01

1) Accessories, must be ordered separately.

SL cutting heads with CoroTurn® HP

For external turning

CoroTurn® TR screw clamp design

With high pressure coolant

Entering angle:
Lead angle:

TR-SL-V13JBR/L-HP-X

κr 93°
-3°



 TR-VB

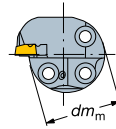
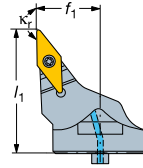

Right hand style shown when nothing else is stated

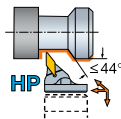
Main application	Insert size	Ordering code	Dimensions, mm, inch					Gauge insert		Nm ³⁾	
			$dm_m^{4)}$	f_1	l_1	$\gamma^{1)}$	$\lambda_s^{2)}$	ISO	ANSI		
	13	TR-SL-V13JBR/L-32HP-X	32	22.0	42	0°	0°	TR-VB1308	TR-VB1308	2.0	
				1.260	.866	1.654	0°	0°			
		TR-SL-V13JBR/L-40HP-X	40	27.0	42	0°	0°	TR-VB1308	TR-VB1308	2.0	
					1.575	1.063	1.654	0°	0°		

1) γ = Rake angle (valid with flat insert).

2) λ_s = Angle of inclination.

3) Insert tightening torque, ft-lbs (Nm).

4) Coupling size, mm

R = Right hand, L = Left hand

Main spare parts

Insert size	Insert screw	Key (Torx Plus/mm)	Torque wrench ¹⁾	Nozzle (hole dia.)	Locating tube
13	5513 020-64	5680 049-04 (10IP)	5680 100-05	5691 026-03 (1.0)	5638 031-01

1) Accessories, must be ordered separately.

CoroTurn® SL70

Coromant Capto® adapter

Coromant Capto® 0°

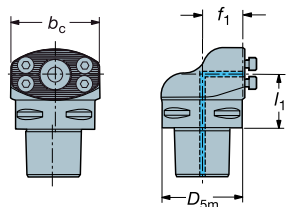

Left hand style shown

Coromant Capto® 5°

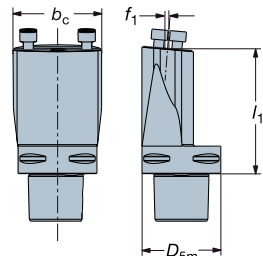

Coromant Capto® 45°

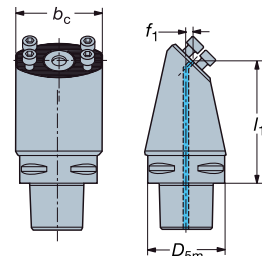

Coromant Capto® 90°

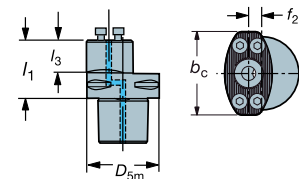

With internal coolant supply

Right hand style shown when nothing else is stated

Type	Ordering code	Shank style	Coupling size, mm		Dimensions, mm, inch					
			b_c	D_{5m}	f_1	f_{21}	l_1	l_3	$\frac{R}{mm}$	
	C5-SL70-LF-043	0°	70	50	33		43			1.3
	C6-SL70-LF-043		70	63	33		43			1.7
	C8-SL70-LF-051		70	80	41.5		51			3.1
	C6-SL70-RX-005-100	5°	70	63			100			2.0
				2.480			3.937			
	C6-SL70-RX-045-100	45°	70	63	5		100			2.7
				2.480	.197		3.937			
	C5-SL70-RG-050	90°	70	50		11.5	50	30.5		0.9
	C6-SL70-RG-050		70	63	11.5	11.5	50	28.5		1.3
	C8-SL70-RG-090		70	80		35	90	61		2.9
				3.150		1.378	3.543	2.402		

Spare parts

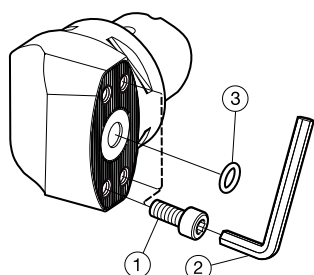

	1	2	3
Ordering code	Screw	Key (mm)	O-ring
C5-SL70-LF-043	3212 010-409	3021 010-060 (6.0)	3671 010-119
C5-SL70-RG-050	3212 010-409	3021 010-060 (6.0)	3671 010-119
C6-SL70-LF-043	3212 010-409	3021 010-060 (6.0)	3671 010-119
C6-SL70-RX-005-100	3212 010-409	3021 010-060 (6.0)	3671 010-119
C6-SL70-RX-045-100	3212 010-409	3021 010-060 (6.0)	3671 010-119
C6-SL70-RG-050	3212 010-409	3021 010-060 (6.0)	3671 010-119
C8-SL70-LF-051	3212 010-409	3021 010-060 (6.0)	3671 010-119
C8-SL70-RG-090	3212 010-409	3021 010-060 (6.0)	3671 010-119

Cutting heads with CoroTurn® SL70 coupling

For round inserts

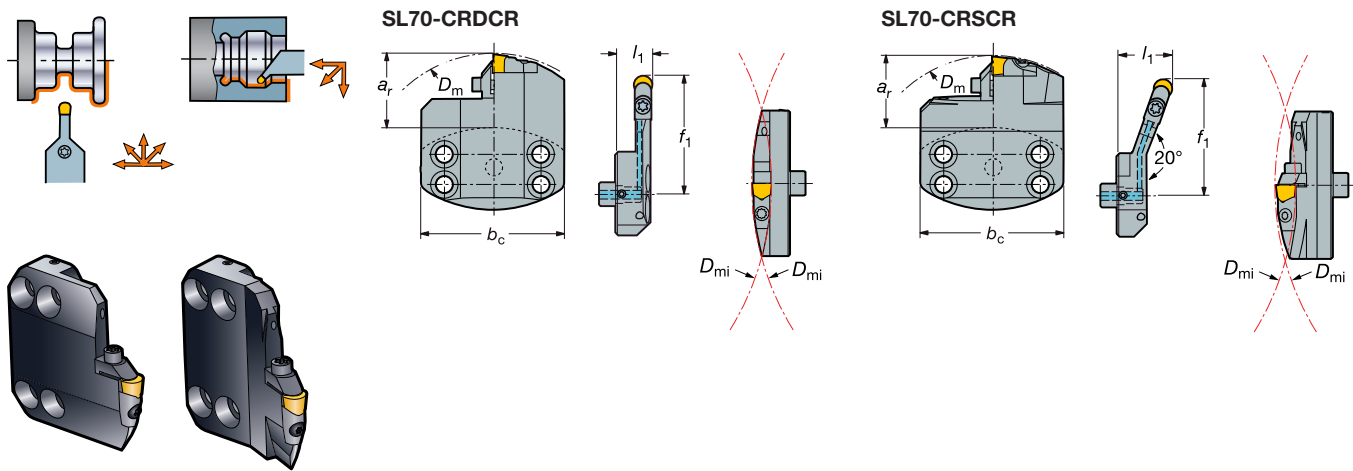

With internal coolant supply

Right hand style shown when nothing else is stated

First cut diameter, mm, inch				Coupling size, mm	Dimensions, mm, inch				Gauge inserts	Nm ¹⁾
D_{mi}	iC	iC	Ordering code	b_c	a_r	$D_{m \text{ min}}$	f_1	l_1		
270 10.630	09	3/8	SL70-CRDCR/L-18-09	70	18 .738	125.0 4.921	39.0 1.535	18.0 .709	RCGX 09 07 00	7.5
270 10.630			SL70-CRDCR/L-35-09	70	35 1.407	125.0 4.921	56.0 2.205	18.0 .709	RCGX 09 07 00	7.5
270 10.630			SL70-CRSCR/L-35-09	70	35 1.378	130.0 5.118	55.0 2.165	26.7 1.051	RCGX 09 07 00	7.5
500 19.684			SL70-CRDCR/L-50-09	70	50 1.998	125.0 4.921	71.0 2.795	16.5 .650	RCGX 09 07 00	7.5
270 10.630	12	1/2	SL70-CRDCR/L-35-12	70	35 1.407	180.0 7.087	56.0 2.205	18.0 .709	RCGX 12 07 00	7.5
270 10.630			SL70-CRDCR/L-50-12	70	50 1.998	180.0 7.087	71.0 2.795	18.0 .709	RCGX 12 07 00	7.5
320 12.598			SL70-CRDCR/L-75-12	70	75 2.982	180.0 7.087	96.0 3.780	18.0 .709	RCGX 12 07 00	7.5

1) Insert tightening torque, ft-lbs. Use torque wrench, see page B7.

R = Right hand, L = Left hand

Main spare parts

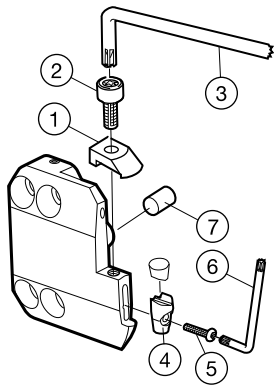

Insert size	1.	2.	3.	4.	5.	6.	7.
iC	Clamp	Clamp screw	Key	Seat	Seat screw	Key	Guide bush
09 3/8	5412 100-01	3212 035-452	5680 043-16 (27IP)	5321 067-01	3212 106-352	5680 043-12 (10IP)	5552 058-04
12 1/2	5412 100-02	3212 106-504	5680 043-16 (27IP)	5321 067-02	3212 105-453	5680 043-15 (25IP)	5552 058-04

Cutting heads with CoroTurn® SL70 coupling

CoroTurn® 107 screw clamp

With high pressure coolant

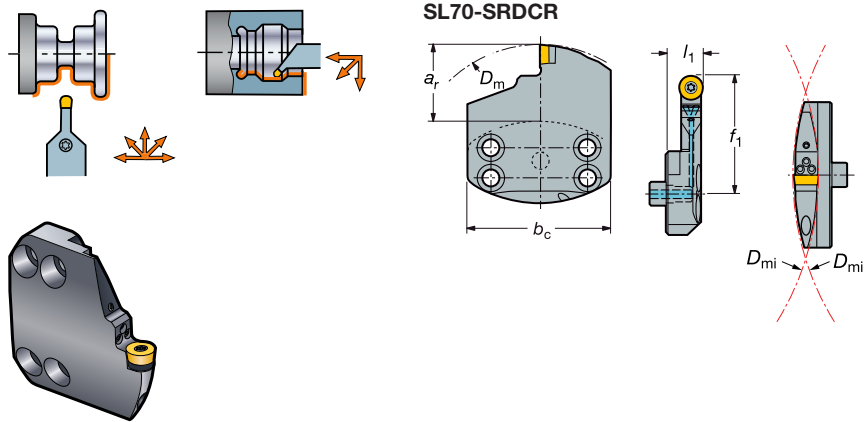

With internal coolant supply

Right hand style shown when nothing else is stated

Metric version

First cut diameter, inch			Coupling size, mm	Dimensions					Gauge inserts	Nm ¹⁾
D_{mi}	$\frac{\text{O}}{\text{H}}$	Ordering code	b_c	a_r	$D_{m \text{ min}}$	f_1	l_1			
250	10	SL70-SRD CR/L-20-10HP	70	20	120	41	17	RCMT 10 T3 M0	3.0	
250		SL70-SRD CR/L-35-10HP	70	35	120	56	17	RCMT 10 T3 M0	3.0	
300	12	SL70-SRD CR/L-35-12HP	70	35	120	56	18	RCMT 12 04 M0	3.0	
300		SL70-SRD CR/L-50-12HP	70	50	120	71	18	RCMT 12 04 M0	3.0	
300		SL70-SRD CR/L-75-12HP	70	75	120	96	18	RCMT 12 04 M0	3.0	

¹⁾ Insert tightening torque, ft-lbs. Use torque wrench, see page B7.

R = Right hand, L = Left hand

Main spare parts

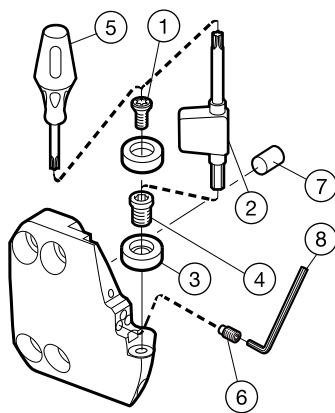

Insert size	1.	2.	3.	4.	5.	6.	7.	8.	
$\frac{\text{O}}{\text{H}}$	iC	Insert screw	Key (Torx Plus)	Shim	Shim screw	Torque wrench	Nozzle (hole diameter, mm)	Guide bush	Coolant nozzle key
10	.394	5513 020-10	5680 049-01 (15IP)	5322 110-01	5512 090-01	5680 100-06 (15IP)	5691 026-03 (1.0)	5552 058-04	174.1-870 (2mm)
12	.472	5513 020-01	5680 049-01 (15IP)	5322 110-02	5512 090-01	5680 105-05 (15IP)	5691 026-13 (1.0)	5552 058-04	174.1-872 (1.5mm)

Optional nozzles (to be ordered separately)

Ordering code	Hole diameter, mm
5691 026-01	0.6
5691 026-02	0.8
5691 026-04	1.2
5691 026-05	1.4

Cutting heads with CoroTurn® SL70 coupling

CoroTurn® 107 screw clamp

With high pressure coolant

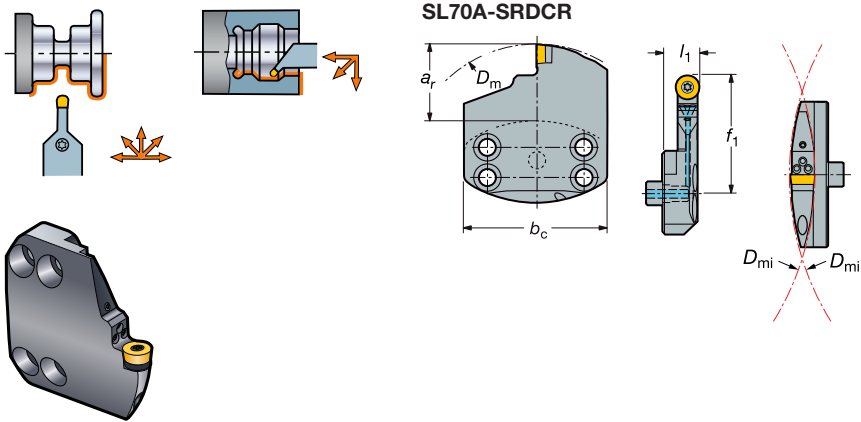

With internal coolant supply

Right hand style shown when nothing else is stated

Inch version

First cut diameter, inch		Ordering code	Coupling size, inch		Dimensions, inch			Gauge inserts	ft-lbs ¹⁾
D_{mi}	iC		b_c	a_r	$D_{m \text{ min}}$	f_1	l_1		
10.236	1/2	SL70A-SRDCR/L-125-4HP	2.756	1.250	4.724	2.205	.669	RCMT 12 04 00	2.2
10.236		SL70A-SRDCR/L-200-4HP	2.756	2.000	4.724	2.795	.709	RCMT 12 04 00	2.2
10.236		SL70A-SRDCR/L-300-4HP	2.756	3.000	4.724	2.205	.709	RCMT 12 04 00	2.2

¹⁾ Insert tightening torque, ft-lbs. Use torque wrench, see page B7.

R = Right hand, L = Left hand

Main spare parts

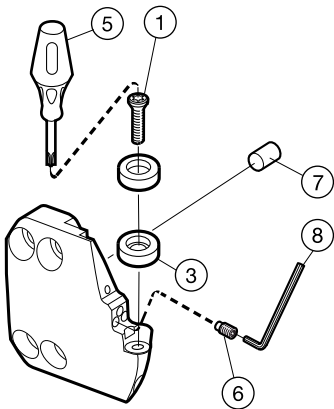

Insert size	1.	3.	5.	6.	7.	8.	
				Thread, M4x.7			
$\frac{\text{O}}{\text{I-C}}$	iC	Insert screw	Shim	Torque wrench	Nozzle (hole diameter, mm)	Guide bush	Coolant nozzle key
12.7	1/2	5513 020-01	5322 120-02	5680 049-01	5691 026-13 (1.0)	5552 058-04	174.1-862 (1.5 mm)

Optional nozzles (to be ordered separately)

Ordering code	Hole diameter, mm
5691 026-01	0.6
5691 026-02	0.8
5691 026-04	1.2
5691 026-05	1.4

CoroCut® SL70

Blade for grooving, profiling and turning

Screw clamp

With high pressure coolant

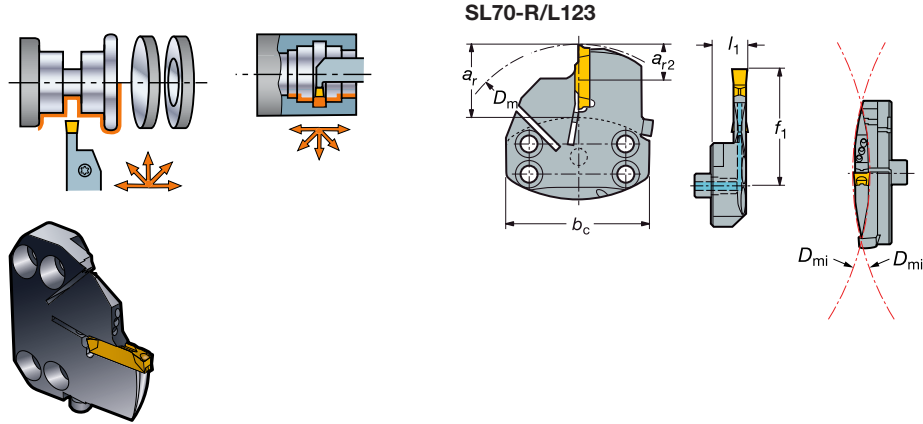

With internal coolant supply

Right hand style shown

First cut diameter, mm, inch				Seat size ¹⁾	Ordering code	Coupling size, mm	Dimensions, mm, inch		Gauge inserts	Nm ²⁾
D_{mi}	D_m min	a_r max	a_{r2} ³⁾				b_c	l_1		
800	100	15		G	SL70-R/L123G15A-HP	70	15.5 .610	48 1.890	N123G2-0300- GM	2.0
31.496	3.937	.591								
800	100	30		H	SL70-R/L123H30A-HP	70	16 .630	56 2.205	N123H2-0400- GM	5.0
31.496	3.937	1.181								
320	120	15.75		K	SL70-R/L123K15A-HP	70	18 .709	36 1.417	N123K2-0600- GM	2.0
12.598	4.724	.620								
320	120	30.35			SL70-R/L123K30A-HP-M	70	17 .669	55 2.165	N123K2-0600- GM	6.0
12.598	4.724	1.195								
320	120	45			SL70-R/L123K45A-HP	70	18 .709	71 2.795	N123K2-0600- GM	6.0
12.598	4.724	1.772								
270	90	35.75		L	SL70-R/L123L35A-HP-M	70	18 .709	61 2.402	N123L2-0800- GM	6.5
10.630	3.543	1.407								
340	105	50			SL70-R/L123L50A-HP	70	18 .709	81 3.189	N123L2-0800- GM	6.5
13.386	4.134	1.968								
450	100	50	25	M	SL70-R/L123M50A-HP	70	17.5 .689	71 2.795	N123M1-1100- GM	5.0
17.716	3.937	1.968	.984							
500	125	65		R	SL70-R/L123R65A-HP	70	16.5 .650	71 2.795	N123R1-1500- GR	6.5
19.685	4.921	2.560								

¹⁾ To correspond with seat size on insert.

²⁾ Insert tightening torque, ft-lbs. Use torque wrench, see page B7.

³⁾ a_{r2} = max face grooving depth

Spare parts

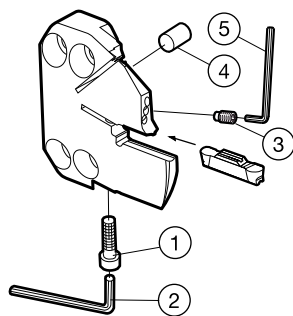

	1.	2.	3.	4.	5.
Ordering code	Screw	Key	Nozzle (hole diameter, mm)	Guide bush	Coolant nozzle key
SL70-R/L123G15A-HP	3212 010-312	3021 010-040 (4.0)	5691 026-23 (1.0)	5552 058-04	3021 012-013 (1.3 mm)
SL70-R/L123H30A-HP	3212 010-312	3021 010-040 (4.0)	5691 026-23 (1.0)	5552 058-04	3021 012-013 (1.3 mm)
SL70-R/L123K15A-HP	3212 010-306	3021 010-040 (4.0)	5691 026-13 (1.0)	5552 058-04	174.1-862 (1.5 mm)
SL70-R/L123K30A-HP	3212 010-314	3021 010-040 (4.0)	5691 026-13 (1.0)	5552 058-04	174.1-862 (1.5 mm)
SL70-R/L123K45A-HP	3212 010-313	3021 010-040 (4.0)	5691 026-13 (1.0)	5552 058-04	174.1-862 (1.5 mm)
SL70-R/L123L35A-HP	3212 010-314	3021 010-040 (4.0)	5691 026-13 (1.0)	5552 058-04	174.1-862 (1.5 mm)
SL70-R/L123L50A-HP	3212 010-313	3021 010-040 (4.0)	5691 026-13 (1.0)	5552 058-04	174.1-862 (1.5 mm)
SL70-R/L123M50A-HP	3212 010-314	3021 010-040 (4.0)	5691 026-13 (1.0)	5552 058-04	174.1-862 (1.5 mm)
SL70-R/L123R65A-HP	3212 010-365	3021 010-050 (5.0)	5691 026-13 (1.0)	5552 058-04	174.1-862 (1.5 mm)

Optional nozzles (to be ordered separately)

Ordering code	Hole diameter, mm
5691 026-11	0.6
5691 026-12	0.8
5691 026-14	1.2
5691 026-15	1.4

CoroCut® SL70

Blade for face grooving

Screw clamp

With high pressure coolant

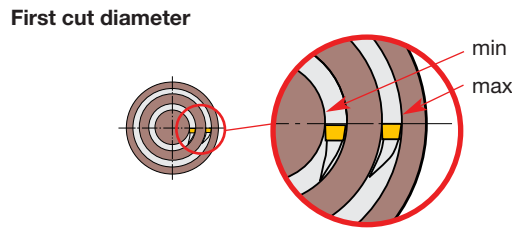
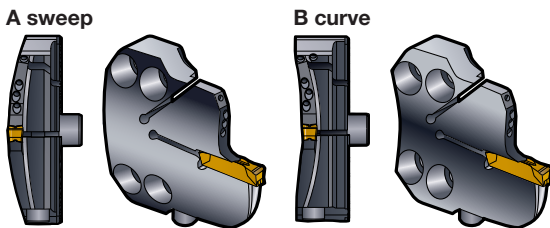
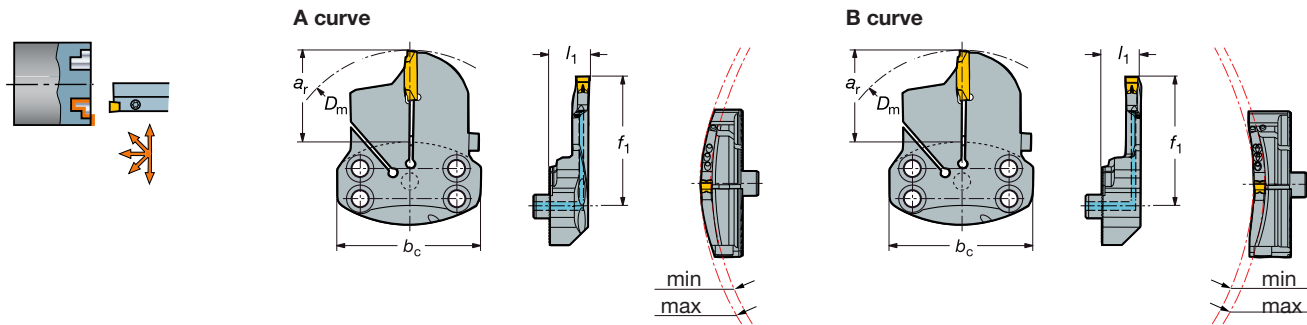

With internal coolant supply

Right hand style shown

A curve

First cut diameter, millimeter, inch (mm, in.)						A curve		Dimensions, millimeter, inch (mm, in.)						
min mm	min in.	max mm	max in.	ar max mm	ar max in.	Seat size ¹⁾	Ordering code	bc ³⁾	f1 mm	f1 in.	h mm	h in.	Gauge inserts	Nm ²⁾
290	11.417	500	19.685	40	1.575	H	SL70-R/L123H40B290A-HP	70	66	2.598	17	.669	N123H2-0400- TF	5.6
290	11.417	500	19.685	40	1.575	J	SL70-R/L123J40B290A-HP	70	66	2.598	17.5	.689	N123J2-0500- TF	5.6
168	6.614	300	11.811	40	1.575	K	SL70-R/L123K40B168A-HP	70	66	2.598	20	.709	N123K2-0600- TF	5.6
288	11.339	500	19.685	40	1.575		SL70-R/L123K40B288A-HP	70	66	2.598	18	.709	N123K2-0600- TF	5.5

B curve

First cut diameter, millimeter, inch (mm, in.)						B curve		Dimensions, millimeter, inch (mm, in.)						
min mm	min in.	max mm	max in.	ar max mm	ar max in.	Seat size ¹⁾	Ordering code	bc ³⁾	f1 mm	f1 in.	h mm	h in.	Gauge inserts	Nm ²⁾
80	3.150	130	5.118	15	.591	H	SL70-R/L123H15B080B-HP	70	53	2.087	15	.591	N123H2-0400- TF	4.0
120	4.724	200	7.874	15	.591		SL70-R/L123H15B120B-HP	70	53	2.087	15	.591	N123H2-0400- TF	4.0
190	7.480	300	11.811	15	.591		SL70-R/L123H15B190B-HP	70	53	2.087	15	.591	N123H2-0400- TF	4.0
290	11.417	500	19.685	40	1.575		SL70-R/L123H40B290B-HP	70	66	2.598	17	.669	N123H2-0400- TF	5.6
290	11.417	500	19.685	40	1.575	J	SL70-R/L123J40B290B-HP	70	66	2.598	17.5	.689	N123J2-0500- TF	5.6
168	6.614	300	11.811	40	1.575	K	SL70-R/L123K40B168B-HP	70	66	2.598	20	.709	N123K2-0600- TF	5.6
288	11.339	500	19.685	40	1.575		SL70-R/L123K40B288B-HP	70	66	2.598	18	.709	N123K2-0600- TF	5.5

1) To correspond with seat size on insert.

2) Insert tightening torque, ft-lbs. Use torque wrench, see page B7.

3) Coupling size, mm

R = Right hand, L = Left hand

Spare parts

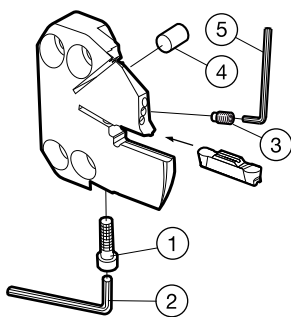

	1.	2.	3.	4.	5.
Seat size	Screw	Key	Nozzle (hole diameter, mm)	Guide bush	Coolant nozzle key
H	3212 010-312	3021 010-040(4.0)	5691 026-23 (1.0)	5552 058-04	3021 012-013 (1.3 mm)
J, K	3212 010-313	3021 010-040(4.0)	5691 026-13 (1.0)	5552 058-04	174.1-862 (1.5 mm)

Optional nozzles (to be ordered separately)

Ordering code	Hole diameter, mm
5691 026-11	0.6
5691 026-12	0.8
5691 026-14	1.2
5691 026-15	1.4

Torque wrenches for correct insert clamping

Information

To get the best performance out of our tools, especially in parting and grooving, it is of great importance to have the correct insert tightening torque. In the Sandvik Coromant assortment, four metric and four inch torque wrenches using bits for different Torx Plus sizes are available.

Sizes -01, -02, -03, -04



Sizes -05, -06, -07, -08

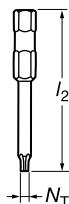
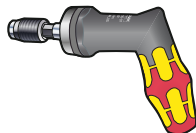

Torque wrench	Torque range		Handle
	Nm	In-lbs	
5680 105-01	0.3 - 1.2		Straight
5680 105-02	1.2 - 3.0		Straight
5680 105-05	3.0 - 6.0		Angled
5680 105-06	4.0 - 8.8		Angled
5680 105-03		2.5 - 11.5	Straight
5680 105-04		11.0 - 26.0	Straight
5680 105-07		26.0 - 55.0	Angled
5680 105-08		35.4 - 78.0	Angled

Bit	l ₂		N _T Torx Plus
	mm	Inch	
5680 084-01	50	1.969	8IP
5680 084-02	50	1.969	15IP
5680 084-03	89	3.504	15IP
5680 084-04	50	1.969	7IP
5680 084-05	50	1.969	9IP
5680 084-06	50	1.969	10IP
5680 084-07	50	1.969	20IP
5680 084-08	89	3.504	20IP
5680 084-09	89	3.504	25IP
5680 084-10	89	3.504	30IP
5680 084-11	50	1.969	6IP
5680 084-12	80	3.150	27IP

Hexagon bits for CoroTurn SL70 cutting heads

Hexagon bits are now available to set the correct insert tightening torque for CoroTurn SL70 heads.

All bits are available in one box, which includes all of the required sizes.

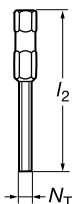

Bit	l ₂		N _T mm	N _T Inch
	mm	Inch		
5680 110-01	50	1.969	1.5, 2.0, 2.5, 3.0, 4.0, 5.0, 6.0	
5680 111-01	50	1.969		1/16", 5/64", 3/32", 7/64", 1/8", 9/64", 5/32", 3/16", 7/32", 1/4"



The power of precision.

Just as high pressure can turn coal into diamonds, it can turn your machining into a gold mine. High pressure coolant significantly improves chip control, allowing unmanned production, increased speeds and over 50% more tool life for roughing to finishing, even in difficult materials like titanium and nickel alloys.

CoroTurn HP is a pioneering high pressure coolant system combined with the ultra-secure Coromant Capto coupling. The system's fixed nozzles target the coolant precisely where you need it every time, with no manual adjustment required, a high precision and accuracy which can even be experienced at low pressure.

When the pressure is on to increase your machine's efficiency talk to your local Sandvik Coromant representative for more information.

Think smart | Work smart | Earn smart

For more information please check our catalog supplement or visit www.aero-knowledge.com

1-800-SANDVIK (1-800-726-3845)
www.sandvik.coromant.com/us
E-mail: us.coromant@sandvik.com

C-1040:091 US/01 © AB Sandvik Coromant 2010.06
Printed on recyclable paper. Printed in Sweden, AB Sandvikens Tryckeri.



Your success in focus