

GENERAL INFORMATION

POWER-STUD® + SD1

Wedge Expansion Anchor

PRODUCT DESCRIPTION

The Power-Stud+ SD1 anchor is a fully threaded, torque-controlled, wedge expansion anchor which is designed for consistent performance in cracked and uncracked concrete. Suitable base materials include normal-weight concrete, sand-lightweight concrete, concrete over steel deck, and grouted concrete masonry. The anchor is manufactured with a zinc plated carbon steel body and expansion clip for premium performance. Nut and washer are included.

GENERAL APPLICATIONS AND USES

- Structural connections, i.e., beam and column anchorage
- Safety-related attachments
- Interior applications / low level corrosion environment
- Tension zone applications, i.e., cable trays and strut, pipe supports, fire sprinklers
- Seismic and wind loading

FEATURES AND BENEFITS

- + Consistent performance in high and low strength concrete
- + Nominal drill bit size is the same as the anchor diameter
- + Anchor can be installed through standard fixture holes
- + Length ID code and identifying marking stamped on head of each anchor
- + Anchor design allows for follow-up expansion after setting under tensile loading

APPROVALS AND LISTINGS

- International Code Council, Evaluation Service (ICC-ES), ESR-2818 for concrete Code compliant with the 2015 IBC, 2015 IRC, 2012 IBC, 2012 IRC, 2009 IBC, 2009 IRC, 2006 IBC and 2006 IRC.
- International Code Council, Evaluation Service (ICC-ES), ESR-2966 for masonry Code compliant with the 2012 IBC, 2012 IRC, 2009 IBC, 2009 IRC, 2006 IBC, and 2006 IRC.
- Tested in accordance with ACI 355.2/ASTM E 488 and ICC-ES AC193 for use in structural concrete under the design provisions of ACI 318 (Strength Design method using Appendix D)
- Evaluated and qualified by an accredited independent testing laboratory for recognition in cracked and uncracked concrete including seismic and wind loading (Category 1 anchors)
- Tested in accordance with ICC-ES AC01 for use in Masonry
- Underwriters Laboratories (UL Listed) - File No. EX1289. See listing for sizes.

GUIDE SPECIFICATIONS

CSI Divisions: 03 16 00 - Concrete Anchors, 04 05 19.16 - Masonry Anchors and 05 05 19 - Post-Installed Concrete Anchors. Expansion anchors shall be Power-Stud+ SD1 as supplied by Brewster, NY. Anchors shall be installed in accordance with published instructions and the Authority Having Jurisdiction.

SECTION CONTENTS

General Information..... 1
 Material Specifications.....2
 Installation Instructions.....2
 Reference Data (ASD).....3
 Strength Design (SD).....9
 Ordering Information..... 14



POWER-STUD+ SD1 ASSEMBLY

THREAD VERSION

- UNC threaded stud

ANCHOR MATERIALS

- Zinc plated carbon steel body with expansion clip, nut and washer

ANCHOR SIZE RANGE (TYP.)

- 1/4" diameter through 1-1/4" diameter

SUITABLE BASE MATERIALS

- Normal-weight concrete
- Structural sand-lightweight concrete
- Concrete over steel deck
- Grouted concrete masonry (CMU)

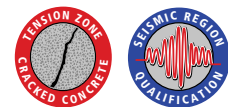

This Product Available In



Powers Design Assist®
 Real-Time Anchor Design Software
www.powersdesignassist.com

CODE LISTED
 ICC-ES ESR-2818
 CONCRETE

CODE LISTED
 ICC-ES ESR-2966
 MASONRY

MATERIAL SPECIFICATIONS

Anchor component	Specification
Anchor Body	Medium carbon steel
Hex nut	Carbon steel, ASTM A 563, Grade A
Washer	Carbon Steel, ASTM F 844; meets dimensional requirements of ANSI B18.22.2. Type A Plain
Expansion wedge (clip)	Carbon Steel
Plating	Zinc plating according to ASTM B 633, SC1 Type III (Fe/Zn 5). Minimum plating requirements for Mild Service Condition.

INSTALLATION INSTRUCTIONS

Installation Instructions for Power-Stud+ SD1

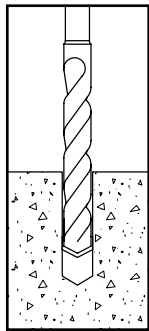

Step 1
Using the proper drill bit size, drill a hole into the base material to the required depth. The tolerances of the drill bit used should meet the requirements of ANSI Standard B212.15.

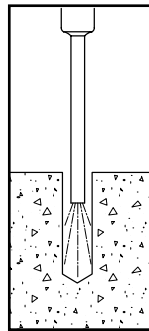

Step 2
Remove dust and debris from the hole, using a hand pump, compressed air or a vacuum to remove loose particles left from drilling.

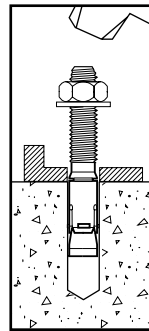

Step 3
Position the washer on the anchor and thread on the nut. If installing through a fixture, drive the anchor through the fixture into the hole. Be sure the anchor is driven to the minimum required embedment depth, h_{nom} .

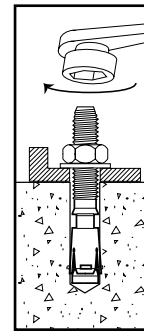

Step 4
Tighten the anchor with a torque wrench by applying the required installation torque, T_{inst} . Note: The threaded stud will draw up during tightening of the nut; the expansion wedge (clip) remains in original position.

Power-Stud+ SD1 Anchor Detail

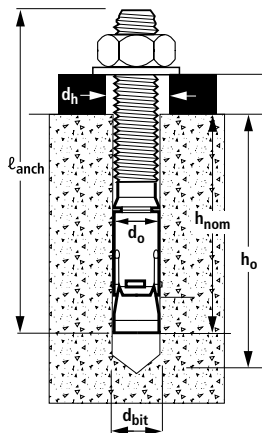

Power-Stud+ SD1 Anchor Assembly

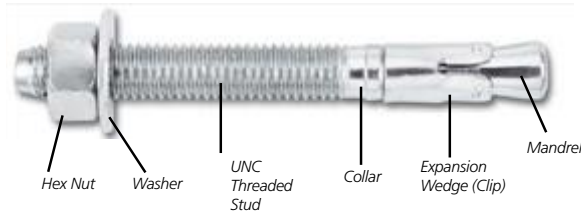

Head Marking



- Legend**
- Letter Code = Length Identification Mark
 - '+' Symbol = Strength Design Compliant Anchor (see ordering information)
 - Number Code = Carbon Steel Body and Carbon Steel Expansion Clip (not on 1/4" diameter anchors)

Length Identification

Mark	A	B	C	D	E	F	G	H	I	J	K	L	M	N	O	P	Q	R	S	T
From	1-1/2"	2"	2-1/2"	3"	3-1/2"	4"	4-1/2"	5"	5-1/2"	6"	6-1/2"	7"	7-1/2"	8"	8-1/2"	9"	9-1/2"	10"	11"	12"
Up to but not including	2"	2-1/2"	3"	3-1/2"	4"	4-1/2"	5"	5-1/2"	6"	6-1/2"	7"	7-1/2"	8"	8-1/2"	9"	9-1/2"	10"	11"	12"	13"

Length identification mark indicates overall length of anchor.

MECHANICAL ANCHORS
POWER-STUD® + SD1
Wedge Expansion Anchor

REFERENCE DATA (ASD)

Installation Specifications for Power-Stud+ SD1 in Concrete^{1,2}

Anchor Property/ Setting Information	Notation	Units	Nominal Anchor Diameter							
			1/4	3/8	1/2	5/8	3/4	7/8	1	1-1/4
Anchor diameter	d _o	in. (mm)	0.250 (6.4)	0.375 (9.5)	0.500 (12.7)	0.625 (15.9)	0.750 (19.1)	0.875 (22.2)	1.000 (25.4)	1.250 (31.8)
Minimum diameter of hole clearance in fixture	d _h	in. (mm)	5/16 (7.5)	7/16 (11.1)	9/16 (14.3)	11/16 (17.5)	13/16 (20.6)	1 (25.4)	1-1/8 (28.6)	1-3/8 (34.9)
Nominal drill bit diameter	d _{bit}	in. ANSI	1/4" ANSI	3/8" ANSI	1/2" ANSI	5/8" ANSI	3/4" ANSI	7/8" ANSI	1" ANSI	1-1/4" ANSI
Minimum nominal embedment depth	h _{nom}	in. (mm)	1-1/8 (29)	1-5/8 (41)	2-1/4 (57)	2-3/4 (70)	3-3/8 (86)	4-1/2 (114)	4-1/2 (114)	6-1/2 (165)
Minimum hole depth	h _o	in. (mm)	1-1/4 (48)	1-3/4 (44)	2-1/2 (64)	3-1/8 (79)	3-5/8 (92)	4-7/8 (122)	4-7/8 (122)	7-1/4 (184)
Installation torque	T _{inst}	ft.-lbf. (N-m)	4 (5)	20 (27)	40 (54)	80 (108)	110 (149)	175 (237)	225 (305)	375 (508)
Torque wrench/ socket size	-	in.	7/16	9/16	3/4	15/16	1-1/8	1-5/16	1-1/2	1-7/8
Nut height	-	In.	7/32	21/64	7/16	35/64	41/64	3/4	55/64	1-1/16

For SI: 1 inch = 25.4 mm, 1 ft-lbf = 1.356 N-m.

- The minimum base material thickness should be 1.5h_{nom} or 3", whichever is greater.
- See Performance Data in Concrete for additional embedment depths.

Ultimate Load Capacities for Power-Stud+ SD1 in Normal-Weight Concrete^{1,2}

Nominal Anchor Diameter in.	Minimum Embedment Depth in. (mm)	Minimum Concrete Compressive Strength							
		f'c = 2,500 psi (17.3 MPa)		f'c = 3,000 psi (20.7 MPa)		f'c = 4,000 psi (27.6 MPa)		f'c = 6,000 psi (41.4 MPa)	
		Tension lbs. (kN)	Shear lbs. (kN)	Tension lbs. (kN)	Shear lbs. (kN)	Tension lbs. (kN)	Shear lbs. (kN)	Tension lbs. (kN)	Shear lbs. (kN)
1/4	1-1/8 (28)	-	-	1,435 (6.4)	1,255 (5.6)	1,660 (7.4)	1,255 (5.6)	-	-
	1-3/4 (44)	2,775 (12.4)	1,255 (5.6)	2,775 (12.4)	1,255 (5.6)	2,775 (12.4)	1,255 (5.6)	2,775 (12.4)	1,255 (5.6)
3/8	1-5/8 (41)	-	-	2,685 (12)	2,540 (11.3)	3,100 (13.8)	2,540 (11.3)	-	-
	2-3/8 (60)	3,485 (15.5)	2,540 (11.3)	3,815 (17)	2,540 (11.3)	4,410 (19.6)	2,540 (11.3)	5,400 (24)	2,540 (11.3)
1/2	2-1/4 (57)	-	-	4,155 (18.5)	4,195 (18.7)	4,800 (21.4)	4,195 (18.7)	-	-
	2-1/2 (64)	3,910 (17.4)	4,195 (18.7)	4,285 (19.1)	4,195 (18.7)	4,950 (22)	4,195 (18.7)	6,060 (27)	4,195 (18.7)
	3-3/4 (95)	7,955 (35.4)	4,195 (18.7)	8,715 (38.8)	4,195 (18.7)	10,065 (44.8)	4,195 (18.7)	12,325 (54.8)	4,195 (18.7)
5/8	2-3/4 (70)	-	-	5,440 (24.3)	6,815 (30.3)	6,285 (28)	6,815 (30.3)	-	-
	3-3/8 (86)	6,625 (29.5)	6,815 (30.3)	7,260 (32.3)	6,815 (30.3)	8,380 (37.3)	6,815 (30.3)	10,265 (45.7)	6,815 (30.3)
	4-5/8 (117)	11,260 (50.1)	6,815 (30.3)	12,335 (54.9)	6,815 (30.3)	14,245 (63.4)	6,815 (30.3)	14,465 (65.7)	6,815 (30.3)
3/4	3-3/8 (86)	-	-	7,860 (32.2)	12,580 (56.0)	9,075 (40.5)	12,580 (56.0)	-	-
	4 (102)	9,530 (42.4)	12,580 (56.0)	10,440 (46.5)	12,580 (56.0)	12,060 (53.6)	12,580 (56.0)	14,770 (65.7)	12,580 (56.0)
	5-5/8 (143)	17,670 (78.6)	12,580 (56.0)	19,355 (86.1)	12,580 (56.0)	22,350 (99.4)	12,580 (56.0)	25,065 (111.5)	12,580 (56.0)
7/8	3-7/8 (98)	-	-	10,005 (44.5)	11,690 (52.0)	11,555 (51.4)	11,690 (52.0)	-	-
	4-1/2 (114)	11,320 (50.4)	11,690 (52.0)	12,405 (55.2)	11,690 (52.0)	15,125 (67.3)	11,690 (52.0)	19,470 (86.6)	11,690 (52.0)
1	4-1/2 (114)	-	-	13,580 (60.4)	21,155 (94.1)	15,680 (69.7)	21,155 (94.1)	-	-
	5-1/2 (140)	16,535 (73.6)	21,155 (94.1)	18,115 (80.6)	21,155 (94.1)	20,915 (93)	21,155 (94.1)	25,615 (114)	21,155 (94.1)
	8 (203)	-	-	21,530 (95.8)	21,155 (94.1)	24,865 (110.6)	21,155 (94.1)	-	-
1-1/4	5-1/2 (140)	-	-	20,275 (90.9)	29,105 (129.4)	23,410 (105.0)	29,105 (129.4)	-	-
	6-1/2 (165)	22,485 (100.0)	29,105 (129.4)	24,630 (109.6)	29,105 (129.4)	28,440 (126.5)	29,105 (129.4)	37,360 (166.2)	29,105 (129.4)

- Tabulated load values are for anchors installed in uncracked concrete with no edge or spacing considerations. Concrete compressive strength must be at the specified minimum at the time of installation.
- Ultimate load capacities must be reduced by a minimum safety factor of 4.0 or greater to determine allowable working loads.



Allowable Load Capacities for Power-Stud+ SD1 in Normal-Weight Concrete^{1,2,3,4}

Nominal Anchor Diameter (in.)	Minimum Embedment Depth in. (mm)	Minimum Concrete Compressive Strength							
		f'c = 2,500 psi (17.3 MPa)		f'c = 3,000 psi (20.7 MPa)		f'c = 4,000 psi (27.6 MPa)		f'c = 6,000 psi (41.4 MPa)	
		Tension lbs. (kN)	Shear lbs. (kN)	Tension lbs. (kN)	Shear lbs. (kN)	Tension lbs. (kN)	Shear lbs. (kN)	Tension lbs. (kN)	Shear lbs. (kN)
1/4	1-1/8 (28)	-	-	360 (1.6)	315 (1.4)	415 (1.8)	315 (1.4)	-	-
	1-3/4 (44)	695 (3.1)	315 (1.4)	695 (3.1)	315 (1.4)	695 (3.1)	315 (1.4)	695 (3.1)	315 (1.4)
3/8	1-5/8 (41)	-	-	670 (3.0)	635 (2.8)	775 (3.4)	635 (2.8)	-	-
	2-3/8 (60)	870 (3.9)	635 (2.8)	955 (4.2)	635 (2.8)	1,105 (4.9)	635 (2.8)	1,350 (6.0)	635 (2.8)
1/2	2-1/4 (57)	-	-	1,040 (4.6)	1,050 (4.7)	1,200 (5.3)	1,050 (4.7)	-	-
	2-1/2 (64)	980 (4.4)	1,050 (4.7)	1,070 (4.8)	1,050 (4.7)	1,240 (5.5)	1,050 (4.7)	1,515 (6.7)	1,050 (4.7)
	3-3/4 (95)	1,990 (8.9)	1,050 (4.7)	2,180 (9.7)	1,050 (4.7)	2,515 (11.2)	1,050 (4.7)	3,080 (13.7)	1,050 (4.7)
5/8	2-3/4 (70)	-	-	1,360 (6.0)	1,705 (7.6)	1,570 (7.0)	1,705 (7.6)	-	-
	3-3/8 (86)	1,655 (7.4)	1,705 (7.6)	1,815 (8.1)	1,705 (7.6)	2,095 (9.3)	1,705 (7.6)	2,565 (11.4)	1,705 (7.6)
	4-5/8 (117)	2,815 (12.5)	1,705 (7.6)	3,085 (13.7)	1,705 (7.6)	3,560 (15.8)	1,705 (7.6)	3,615 (16.1)	1,705 (7.6)
3/4	3-3/8 (86)	-	-	1,965 (8.7)	3,145 (14.0)	2,270 (10.1)	3,145 (14.0)	-	-
	4 (102)	2,385 (10.6)	3,145 (14.0)	2,610 (11.6)	3,145 (14.0)	3,015 (13.4)	3,145 (14.0)	3,620 (16.1)	3,145 (14.0)
	5-5/8 (143)	4,420 (19.7)	3,145 (14.0)	4,840 (21.5)	3,145 (14.0)	5,590 (24.9)	3,145 (14.0)	6,265 (27.9)	3,145 (14.0)
7/8	3-7/8 (98)	-	-	2,500 (11.1)	2,925 (13.0)	2,890 (12.9)	2,925 (13.0)	-	-
	4-1/2 (114)	2,830 (12.6)	2,925 (13.0)	3,100 (13.8)	2,925 (13.0)	3,780 (16.8)	2,925 (13.0)	4,870 (21.7)	2,925 (13.0)
1	4-1/2 (114)	-	-	3,395 (15.1)	5,290 (23.5)	3,920 (17.4)	5,290 (23.5)	-	-
	5-1/2 (140)	4,135 (18.4)	5,290 (23.5)	4,530 (20.2)	5,290 (23.5)	5,230 (23.3)	5,290 (23.5)	6,405 (28.5)	5,290 (23.5)
	8 (203)	-	-	5,380 (23.9)	5,290 (23.5)	6,215 (27.6)	5,290 (23.5)	-	-
1-1/4	5-1/2 (140)	-	-	5,070 (22.6)	7,275 (32.4)	5,850 (26.0)	7,275 (32.4)	-	-
	6-1/2 (165)	5,620 (25.0)	7,275 (32.4)	6,160 (27.4)	7,275 (32.4)	7,110 (31.6)	7,275 (32.4)	9,340 (41.5)	7,275 (32.4)

1. Tabulated load values are for anchors installed in concrete. Concrete compressive strength must be at the minimum at the time of installation.
2. Allowable load capacities are calculated using an applied safety factor of 4.0.
3. Allowable load capacities must be multiplied by reduction factors when anchor spacing or edge distances are less than critical distances.
4. Linear interpolation may be used to determine allowable loads for intermediate embedments and compressive strengths.

MECHANICAL ANCHORS

POWER-STUD® + SD1
Wedge Expansion Anchor

Edge Distance and Spacing Distance Tension (F_{NS} , F_{NC}) Adjustment Factors for Normal-Weight Concrete

Dia. (in.)	1/4	3/8	1/2	1/2	5/8	5/8	3/4	3/4	7/8	1	1-1/4
h_{nom} (in.)	1-3/4	2-3/8	2-1/2	3-3/4	3-3/8	4-5/8	4	5-5/8	4-1/2	5-1/2	6-1/2
s_{min} (in.)	2-1/4	3-1/2	4-1/2	5	6	4-1/4	6	6-1/2	6-1/2	8	8
2	-	-	-	-	-	-	-	-	-	-	-
2-1/4	0.78	-	-	-	-	-	-	-	-	-	-
2-1/2	0.80	-	-	-	-	-	-	-	-	-	-
2-3/4	0.83	-	-	-	-	-	-	-	-	-	-
3	0.85	-	-	-	-	-	-	-	-	-	-
3-1/2	0.90	0.84	-	-	-	-	-	-	-	-	-
4	0.95	0.87	-	-	-	-	-	-	-	-	-
4-1/4	0.98	0.89	-	-	-	0.72	-	-	-	-	-
4-1/2	1.00	0.90	0.91	-	-	0.73	-	-	-	-	-
5	1.00	0.94	0.94	0.79	-	0.75	-	-	-	-	-
5-1/2	1.00	0.97	0.97	0.81	-	0.77	-	-	-	-	-
6	1.00	1.00	1.00	0.83	0.88	0.79	0.87	-	-	-	-
6-1/2	1.00	1.00	1.00	0.86	0.90	0.80	0.89	0.79	0.85	-	-
7	1.00	1.00	1.00	0.88	0.93	0.82	0.91	0.81	0.87	-	-
7-1/2	1.00	1.00	1.00	0.90	0.96	0.84	0.93	0.82	0.89	-	-
8	1.00	1.00	1.00	0.92	0.99	0.86	0.95	0.83	0.91	0.84	0.82
8-1/2	1.00	1.00	1.00	0.94	1.00	0.88	0.97	0.85	0.93	0.85	0.83
9	1.00	1.00	1.00	0.97	1.00	0.89	0.99	0.86	0.94	0.87	0.84
9-1/2	1.00	1.00	1.00	0.99	1.00	0.91	1.00	0.87	0.96	0.89	0.85
10	1.00	1.00	1.00	1.00	1.00	0.93	1.00	0.89	0.98	0.90	0.86
10-1/2	1.00	1.00	1.00	1.00	1.00	0.95	1.00	0.90	1.00	0.92	0.87
11	1.00	1.00	1.00	1.00	1.00	0.96	1.00	0.91	1.00	0.93	0.88
11-1/2	1.00	1.00	1.00	1.00	1.00	0.98	1.00	0.93	1.00	0.95	0.90
12	1.00	1.00	1.00	1.00	1.00	1.00	1.00	0.94	1.00	0.96	0.91
12-1/2	1.00	1.00	1.00	1.00	1.00	1.00	1.00	0.95	1.00	0.98	0.92
13	1.00	1.00	1.00	1.00	1.00	1.00	1.00	0.97	1.00	1.00	0.93
13-1/2	1.00	1.00	1.00	1.00	1.00	1.00	1.00	0.98	1.00	1.00	0.94
14	1.00	1.00	1.00	1.00	1.00	1.00	1.00	0.99	1.00	1.00	0.95
14-1/2	1.00	1.00	1.00	1.00	1.00	1.00	1.00	1.00	1.00	1.00	0.96
15	1.00	1.00	1.00	1.00	1.00	1.00	1.00	1.00	1.00	1.00	0.97
15-1/2	1.00	1.00	1.00	1.00	1.00	1.00	1.00	1.00	1.00	1.00	0.99
16	1.00	1.00	1.00	1.00	1.00	1.00	1.00	1.00	1.00	1.00	1.00

Dia. (in.)	1/4	3/8	1/2	1/2	5/8	5/8	3/4	3/4	7/8	1	1-1/4
h_{nom} (in.)	1-3/4	2-3/8	2-1/2	3-3/4	3-3/8	4-5/8	4	5-5/8	4-1/2	5-1/2	6-1/2
c_{ac} (in.)	3-1/2	6-1/2	8	8	6	10	11	16	11-1/2	12	20
c_{min} (in.)	1-3/4	2-1/4	3-1/4	2-3/4	5-1/2	4-1/4	5	6	7	8	8
1-3/4	0.50	-	-	-	-	-	-	-	-	-	-
2	0.57	-	-	-	-	-	-	-	-	-	-
2-1/4	0.64	0.35	-	-	-	-	-	-	-	-	-
2-1/2	0.71	0.38	-	-	-	-	-	-	-	-	-
2-3/4	0.79	0.42	-	0.34	-	-	-	-	-	-	-
3	0.86	0.46	-	0.38	-	-	-	-	-	-	-
3-1/4	0.93	0.50	0.41	0.41	-	-	-	-	-	-	-
3-1/2	1.00	0.54	0.44	0.44	-	-	-	-	-	-	-
4	1.00	0.62	0.50	0.50	-	-	-	-	-	-	-
4-1/4	1.00	0.65	0.53	0.53	-	0.43	-	-	-	-	-
4-1/2	1.00	0.69	0.56	0.56	-	0.45	-	-	-	-	-
5	1.00	0.77	0.63	0.63	-	0.50	0.45	-	-	-	-
5-1/2	1.00	0.85	0.69	0.69	0.92	0.55	0.50	-	-	-	-
6	1.00	0.92	0.75	0.75	1.00	0.60	0.55	0.38	-	-	-
6-1/2	1.00	1.00	0.81	0.81	1.00	0.65	0.59	0.41	-	-	-
7	1.00	1.00	0.88	0.88	1.00	0.70	0.64	0.44	0.61	-	-
7-1/2	1.00	1.00	0.94	0.94	1.00	0.75	0.68	0.47	0.65	-	-
8	1.00	1.00	1.00	1.00	1.00	0.80	0.73	0.50	0.70	0.67	0.40
8-1/2	1.00	1.00	1.00	1.00	1.00	0.85	0.77	0.53	0.74	0.71	0.43
9	1.00	1.00	1.00	1.00	1.00	0.90	0.82	0.56	0.78	0.75	0.45
9-1/2	1.00	1.00	1.00	1.00	1.00	0.95	0.86	0.59	0.83	0.79	0.48
10	1.00	1.00	1.00	1.00	1.00	1.00	0.91	0.63	0.87	0.83	0.50
10-1/2	1.00	1.00	1.00	1.00	1.00	1.00	0.95	0.66	0.91	0.88	0.53
11	1.00	1.00	1.00	1.00	1.00	1.00	1.00	0.69	0.96	0.92	0.55
11-1/2	1.00	1.00	1.00	1.00	1.00	1.00	1.00	0.72	1.00	0.96	0.58
12	1.00	1.00	1.00	1.00	1.00	1.00	1.00	0.75	1.00	1.00	0.60
12-1/2	1.00	1.00	1.00	1.00	1.00	1.00	1.00	0.78	1.00	1.00	0.63
13	1.00	1.00	1.00	1.00	1.00	1.00	1.00	0.81	1.00	1.00	0.65
13-1/2	1.00	1.00	1.00	1.00	1.00	1.00	1.00	0.84	1.00	1.00	0.68
14	1.00	1.00	1.00	1.00	1.00	1.00	1.00	0.88	1.00	1.00	0.70
14-1/2	1.00	1.00	1.00	1.00	1.00	1.00	1.00	0.91	1.00	1.00	0.73
15	1.00	1.00	1.00	1.00	1.00	1.00	1.00	0.94	1.00	1.00	0.75
15-1/2	1.00	1.00	1.00	1.00	1.00	1.00	1.00	0.97	1.00	1.00	0.78
16	1.00	1.00	1.00	1.00	1.00	1.00	1.00	1.00	1.00	1.00	0.80
16-1/2	1.00	1.00	1.00	1.00	1.00	1.00	1.00	1.00	1.00	1.00	0.83
17	1.00	1.00	1.00	1.00	1.00	1.00	1.00	1.00	1.00	1.00	0.85
17-1/2	1.00	1.00	1.00	1.00	1.00	1.00	1.00	1.00	1.00	1.00	0.88
18	1.00	1.00	1.00	1.00	1.00	1.00	1.00	1.00	1.00	1.00	0.90
18-1/2	1.00	1.00	1.00	1.00	1.00	1.00	1.00	1.00	1.00	1.00	0.93
19	1.00	1.00	1.00	1.00	1.00	1.00	1.00	1.00	1.00	1.00	0.95
19-1/2	1.00	1.00	1.00	1.00	1.00	1.00	1.00	1.00	1.00	1.00	0.98
20	1.00	1.00	1.00	1.00	1.00	1.00	1.00	1.00	1.00	1.00	1.00

MECHANICAL ANCHORS

POWER-STUD® + SD1

Wedge Expansion Anchor

Spacing Distance Shear (F_{VS}) Adjustment Factors for Normal-Weight Concrete

Di. (in.)	1/4	3/8	1/2	1/2	5/8	5/8	3/4	3/4	7/8	1	1-1/4
h_{nom} (in.)	1-3/4	2-3/8	2-1/2	3-3/4	3-3/8	4-5/8	4	5-5/8	4-1/2	5-1/2	6-1/2
s_{min} (in.)	2-1/4	3-1/2	4-1/2	5	6	4-1/4	6	6-1/2	6-1/2	8	8
Spacing Distance (inches)	2-1/4	0.85	-	-	-	-	-	-	-	-	-
	2-1/2	0.87	-	-	-	-	-	-	-	-	-
	2-3/4	0.88	-	-	-	-	-	-	-	-	-
	3	0.90	-	-	-	-	-	-	-	-	-
	3-1/2	0.93	0.90	-	-	-	-	-	-	-	-
	4	0.97	0.92	-	-	-	-	-	-	-	-
	4-1/4	0.98	0.93	-	-	-	0.82	-	-	-	-
	4-1/2	1.00	0.94	0.95	-	-	0.82	-	-	-	-
	5	1.00	0.96	0.97	0.86	-	0.83	-	-	-	-
	5-1/2	1.00	0.98	0.98	0.87	-	0.85	-	-	-	-
	6	1.00	1.00	1.00	0.89	0.91	0.86	0.92	-	-	-
	6-1/2	1.00	1.00	1.00	0.90	0.93	0.87	0.93	0.88	0.91	-
	7	1.00	1.00	1.00	0.92	0.95	0.88	0.94	0.88	0.92	-
	7-1/2	1.00	1.00	1.00	0.93	0.97	0.89	0.96	0.89	0.93	-
	8	1.00	1.00	1.00	0.95	0.99	0.90	0.97	0.90	0.94	0.90
	8-1/2	1.00	1.00	1.00	0.96	1.00	0.92	0.98	0.91	0.96	0.91
9	1.00	1.00	1.00	0.98	1.00	0.93	0.99	0.92	0.97	0.92	
9-1/2	1.00	1.00	1.00	0.99	1.00	0.94	1.00	0.92	0.98	0.93	
10	1.00	1.00	1.00	1.00	1.00	0.95	1.00	0.93	0.99	0.94	
10-1/2	1.00	1.00	1.00	1.00	1.00	0.96	1.00	0.94	1.00	0.95	
11	1.00	1.00	1.00	1.00	1.00	0.98	1.00	0.95	1.00	0.96	
11-1/2	1.00	1.00	1.00	1.00	1.00	0.99	1.00	0.96	1.00	0.97	
12	1.00	1.00	1.00	1.00	1.00	1.00	0.96	1.00	0.98	0.95	
12-1/2	1.00	1.00	1.00	1.00	1.00	1.00	0.97	1.00	0.99	0.95	
13	1.00	1.00	1.00	1.00	1.00	1.00	0.98	1.00	1.00	0.96	
13-1/2	1.00	1.00	1.00	1.00	1.00	1.00	0.99	1.00	1.00	0.97	
14	1.00	1.00	1.00	1.00	1.00	1.00	1.00	1.00	1.00	0.97	
14-1/2	1.00	1.00	1.00	1.00	1.00	1.00	1.00	1.00	1.00	0.98	
15	1.00	1.00	1.00	1.00	1.00	1.00	1.00	1.00	1.00	0.99	
15-1/2	1.00	1.00	1.00	1.00	1.00	1.00	1.00	1.00	1.00	0.99	
16	1.00	1.00	1.00	1.00	1.00	1.00	1.00	1.00	1.00	1.00	

Di. (in.)	1/4	3/8	1/2	1/2	5/8	5/8	3/4	3/4	7/8	1	1-1/4
h_{nom} (in.)	1-3/4	2-3/8	2-1/2	3-3/4	3-3/8	4-5/8	4	5-5/8	4-1/2	5-1/2	6-1/2
c_{min} (in.)	1-3/4	2-1/4	3-1/4	2-3/4	5-1/2	4-1/4	5	6	7	8	8
Edge Distance (inches)	1-3/4	0.39	-	-	-	-	-	-	-	-	-
	2	0.44	-	-	-	-	-	-	-	-	-
	2-1/4	0.50	0.38	-	-	-	-	-	-	-	-
	2-1/2	0.56	0.42	-	-	-	-	-	-	-	-
	2-3/4	0.61	0.46	-	0.28	-	-	-	-	-	-
	3	0.67	0.50	-	0.31	-	-	-	-	-	-
	3-1/4	0.72	0.54	0.54	0.33	-	-	-	-	-	-
	3-1/2	0.78	0.58	0.58	0.36	-	-	-	-	-	-
	4	0.89	0.67	0.67	0.41	-	-	-	-	-	-
	4-1/4	0.94	0.71	0.71	0.44	-	0.35	-	-	-	-
	4-1/2	1.00	0.75	0.75	0.46	-	0.38	-	-	-	-
	5	1.00	0.83	0.83	0.51	-	0.42	0.53	-	-	-
	5-1/2	1.00	0.92	0.92	0.56	0.67	0.46	0.59	-	-	-
	6	1.00	1.00	1.00	0.62	0.73	0.50	0.64	0.42	-	-
	6-1/2	1.00	1.00	1.00	0.67	0.79	0.54	0.69	0.46	-	-
	7	1.00	1.00	1.00	0.72	0.85	0.58	0.75	0.49	0.67	-
7-1/2	1.00	1.00	1.00	0.77	0.91	0.63	0.80	0.53	0.71	-	
8	1.00	1.00	1.00	0.82	0.97	0.67	0.85	0.56	0.76	0.61	
8-1/2	1.00	1.00	1.00	0.87	1.00	0.71	0.91	0.60	0.81	0.65	
9	1.00	1.00	1.00	0.92	1.00	0.75	0.96	0.63	0.86	0.69	
9-1/2	1.00	1.00	1.00	0.97	1.00	0.79	1.00	0.67	0.90	0.72	
10	1.00	1.00	1.00	1.00	1.00	0.83	1.00	0.70	0.95	0.76	
10-1/2	1.00	1.00	1.00	1.00	1.00	0.88	1.00	0.74	1.00	0.80	
11	1.00	1.00	1.00	1.00	1.00	0.92	1.00	0.77	1.00	0.84	
11-1/2	1.00	1.00	1.00	1.00	1.00	0.96	1.00	0.81	1.00	0.88	
12	1.00	1.00	1.00	1.00	1.00	1.00	0.84	1.00	0.91	0.74	
12-1/2	1.00	1.00	1.00	1.00	1.00	1.00	0.88	1.00	0.95	0.78	
13	1.00	1.00	1.00	1.00	1.00	1.00	0.91	1.00	0.99	0.81	
13-1/2	1.00	1.00	1.00	1.00	1.00	1.00	0.95	1.00	1.00	0.84	
14	1.00	1.00	1.00	1.00	1.00	1.00	0.98	1.00	1.00	0.87	
14-1/2	1.00	1.00	1.00	1.00	1.00	1.00	1.00	1.00	1.00	0.90	
15	1.00	1.00	1.00	1.00	1.00	1.00	1.00	1.00	1.00	0.93	
15-1/2	1.00	1.00	1.00	1.00	1.00	1.00	1.00	1.00	1.00	0.96	
16	1.00	1.00	1.00	1.00	1.00	1.00	1.00	1.00	1.00	0.99	
16-1/2	1.00	1.00	1.00	1.00	1.00	1.00	1.00	1.00	1.00	1.00	

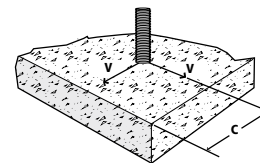
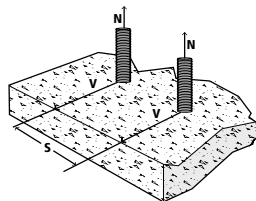

MECHANICAL ANCHORS

POWER-STUD® + SD1
Wedge Expansion Anchor

Ultimate and Allowable Load Capacities in Tension for Power-Stud+ SD1 in Grout Filled Concrete Masonry Wall Faces^{1,2,3,4,5,6,7}

CODE LISTED
ICC-ES ESR-2966



Nominal Anchor Diameter in.	Nominal Drill Bit Diameter in.	Min. Embed. Depth in. (mm)	Min. Edge Distance in. (mm)	Min. End Distance in. (mm)	Installation Torque T _{inst} ft-lbf (N-m)	Grout-Filled Concrete Masonry			
						f'm = 1,500 psi		f'm = 2,000 psi	
						Ultimate Load Tension lbs. (kN)	Allowable Load Tension lbs. (kN)	Ultimate Load Tension lbs. (kN)	Allowable Load Tension lbs. (kN)
3/8	3/8 ANSI	2-3/8 (60.3)	4 (101.6)	4 (101.6)	20 (27)	2,225 (10.0)	445 (2.0)	2,670 (12.0)	535 (2.4)
1/2	1/2 ANSI	2-1/2 (63.5)	4 (101.6)	4 (101.6)	40 (54)	2,650 (11.9)	530 (2.4)	3,180 (14.3)	635 (2.9)
5/8	5/8 ANSI	3-3/8 (85.7)	4 (101.6)	4 (101.6)	50 (68)	3,525 (15.9)	705 (3.2)	4,230 (19.0)	845 (3.8)
3/4	3/4 ANSI	4-3/4 (120.7)	12 (304.8)	12 (304.8)	80 (108)	7,580 (34.1)	1,515 (6.8)	8,755 (39.4)	1,750 (7.9)

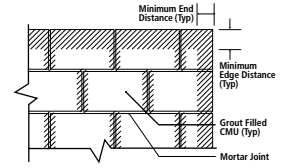

Wall Face Permissible Anchor Locations (Un-hatched Area)

1. Tabulated load values for 3/8", 1/2" and 5/8" diameter anchors are installed in minimum 6" wide, Grade N, Type II, lightweight, medium-weight or normal-weight concrete masonry units conforming to ASTM C 90. Mortar must be minimum Type N. Masonry compressive strength must be at specified minimum at the time of installation.
2. Tabulated load values for 3/4" diameter anchors are installed in minimum 8" wide, Grade N, Type II, lightweight, medium-weight or normal-weight concrete masonry units conforming to ASTM C 90. Mortar must be minimum Type N. Masonry compressive strength must be at specified minimum at the time of installation.
3. Allowable load capacities listed are calculated using an applied safety factor of 5.0.
4. The tabulated values are applicable for anchors installed into grouted masonry wall faces at a critical spacing distance, s_c, between anchors of 16 times the anchor diameter. The spacing distance between two anchors may be reduced to minimum distance, s_{min}, of 8 times the anchor diameter provided the allowable tension loads are multiplied by a reduction factor 0.80 and allowable shear loads are multiplied by a reduction factor of 0.90. Linear interpolation for calculation of allowable loads may be used for intermediate anchor spacing distances.
5. Anchors may be installed in the grouted cells and in cell webs and bed joints not closer than 1-3/8" from head joints. The minimum edge and end distances must also be maintained.
6. Allowable tension values for anchors installed into bed joints of grouted masonry wall faces with a minimum of 12" edge distance and end distance may be increased by 20 percent for the 1/2-inch diameter and 10 percent for the 5/8-inch diameter.
7. 3/4 inch diameter anchor not included in ICC-ES ESR-2966.

Ultimate and Allowable Load Capacities in Shear for Power-Stud+ SD1 in Grout Filled Concrete Masonry Wall Faces^{1,2,3,4,5,6}

CODE LISTED
ICC-ES ESR-2966



Nominal Anchor Diameter in.	Nominal Drill Bit Diameter in.	Min. Embed. Depth in. (mm)	Min. Edge Distance in. (mm)	Min. End Distance in. (mm)	Direction of Loading	Installation Torque T _{inst} ft-lbf (N-m)	Grout-Filled Concrete Masonry			
							f'm = 1,500 psi		f'm = 2,000 psi	
							Ultimate Load Shear lbs. (kN)	Allowable Load Shear lbs. (kN)	Ultimate Load Shear lbs. (kN)	Allowable Load Shear lbs. (kN)
3/8	3/8 ANSI	2-3/8 (60.3)	4 (101.6)	4 (101.6)	Perpendicular or parallel to wall edge or end	20 (27)	2,975 (13.4)	595 (2.7)	3,570 (16.1)	715 (3.2)
1/2	1/2 ANSI	2-1/2 (63.5)	4 (101.6)	12 (304.8)	Perpendicular or parallel to wall edge or end	40 (54)	2,800 (12.6)	560 (2.5)	3,360 (15.1)	670 (3.0)
			12 (304.8)	4 (101.6)	Parallel to wall end		4,025 (18.1)	805 (3.6)	4,830 (21.7)	965 (4.3)
5/8	5/8 ANSI	3-3/8 (85.7)	4 (101.6)	4 (101.6)	Perpendicular or parallel to wall edge or end	50 (68)	3,425 (15.4)	685 (3.1)	4,110 (18.5)	820 (3.7)
			12 (304.8)	4 (101.6)	Parallel to wall end		5,325 (24.0)	1,065 (4.8)	6,390 (28.8)	1,280 (5.8)
			4 (101.6)	12 (304.8)	Parallel to wall edge					
3/4	3/4 ANSI	4-3/4 (120.7)	12 (304.8)	12 (304.8)	Perpendicular or parallel to wall edge or end	80 (108)	12,735 (56.7)	2,545 (11.3)	12,735 (56.7)	2,545 (11.3)

1. Tabulated load values for 3/8", 1/2" and 5/8" diameter anchors are installed in minimum 6" wide, Grade N, Type II, lightweight, medium-weight or normal-weight concrete masonry units conforming to ASTM C 90. Mortar must be minimum Type N. Masonry compressive strength must be at specified minimum at the time of installation.
2. Tabulated load values for 3/4" diameter anchors are installed in minimum 8" wide, Grade N, Type II, lightweight, medium-weight or normal-weight concrete masonry units conforming to ASTM C 90. Mortar must be minimum Type N. Masonry compressive strength must be at specified minimum at the time of installation.
3. Allowable load capacities listed are calculated using an applied safety factor of 5.0.
4. The tabulated values are applicable for anchors installed into grouted masonry wall faces at a critical spacing distance, s_c, between anchors of 16 times the anchor diameter. The spacing distance between two anchors may be reduced to minimum distance, s_{min}, of 8 times the anchor diameter provided the allowable tension loads are multiplied by a reduction factor 0.80 and allowable shear loads are multiplied by a reduction factor of 0.90. Linear interpolation for calculation of allowable loads may be used for intermediate anchor spacing distances.
5. Anchors may be installed in the grouted cells and in cell webs and bed joints not closer than 1-3/8" from head joints. The minimum edge and end distances must also be maintained.
6. 3/4 inch diameter anchor not included in ICC-ES ESR-2966.

Ultimate and Allowable Load Capacities in Tension for Power-Stud+ SD1 in Grout Filled Concrete Masonry Wall Tops^{1,2,3,4}

CODE LISTED
ICC-ES ESR-2966



Nominal Anchor Diameter in.	Nominal Drill Bit Diameter in.	Minimum Embed. Depth in. (mm)	Min. Edge Distance in. (mm)	Min. End Distance in. (mm)	Installation Torque T _{inst} ft-lbf (N-m)	Grout-Filled Concrete Masonry			
						f'm = 1,500 psi		f'm = 2,000 psi	
						Ultimate Load Tension lbs. (kN)	Allowable Load Tension lbs. (kN)	Ultimate Load Tension lbs. (kN)	Allowable Load Tension lbs. (kN)
3/8	3/8 ANSI	2-3/8 (60.3)	1-3/4 (44.5)	12 (304.8)	20 (27)	1,475 (6.6)	295 (1.3)	1,770 (8.0)	355 (1.6)
1/2	1/2 ANSI	2-1/2 (63.5)	2-1/4 (57.1)		40 (54)	2,225 (9.9)	445 (2.0)	2,575 (11.5)	515 (2.3)
		5 (127)			3,425 (15.4)	685 (3.1)	4,110 (18.5)	820 (3.7)	
5/8	5/8 ANSI	3-3/8 (85.7)		50 (68)	3,825 (17.2)	765 (3.4)	4,590 (20.7)	920 (4.1)	

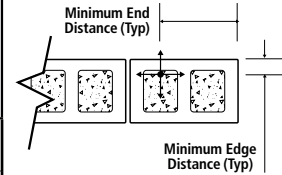

Top of Wall

1. Tabulated load values are for anchors installed in minimum 8-inch wide, minimum Grade N, Type II, lightweight, medium-weight or normal-weight concrete masonry units conforming to ASTM C 90. Mortar must be minimum Type N. Masonry compressive strength must be at the specified minimum at the time of installation.
2. Allowable load capacities listed are calculated using and applied safety factor of 5.0. Consideration of safety factors of 10 or higher may be necessary depending upon the application such as life safety.
3. Anchors must be installed in the grouted cells and the minimum edge and end distances must be maintained.
4. The tabulated values are applicable for anchors installed in top of grouted masonry walls at a critical spacing distance, s_c, between anchors of 16 times the anchor diameter.

Ultimate and Allowable Load Capacities in Shear for Power-Stud+ SD1 in Grout Filled Concrete Masonry Wall Tops^{1,2,3,4}

CODE LISTED
ICC-ES ESR-2966



Nominal Anchor Diameter in.	Nominal Drill Bit Diameter in.	Minimum Embed. Depth in. (mm)	Min. Edge Distance in. (mm)	Min. End Distance in. (mm)	Direction of Loading	Installation Torque T _{inst} ft-lbf (N-m)	Grout-Filled Concrete Masonry			
							f'm = 1,500 psi		f'm = 2,000 psi	
							Ultimate Load Shear lbs. (kN)	Allowable Load Shear lbs. (kN)	Ultimate Load Shear lbs. (kN)	Allowable Load Shear lbs. (kN)
3/8	3/8 ANSI	2-3/8 (60.3)	1-3/4 (44.5)	12 (304.8)	Perpendicular to wall toward minimum edge	20 (27)	1,150 (5.2)	230 (1.0)	1,380 (6.2)	275 (1.2)
					Parallel to wall edge		2,425 (10.9)	485 (2.2)	2,910 (13.1)	580 (2.6)
1/2	1/2 ANSI	2-1/2 (63.5)	2-1/4 (57.1)	12 (304.8)	Any	40 (54)	1,150 (5.2)	230 (1.0)	1,380 (6.2)	275 (1.2)
		5 (127)			Perpendicular to wall toward minimum edge		1,400 (6.3)	280 (1.3)	1,680 (7.6)	325 (1.5)
					Parallel to wall edge		2,825 (12.7)	565 (2.5)	3,390 (15.3)	680 (3.1)
5/8	5/8 ANSI	3-3/8 (85.7)	2-1/4 (57.1)	12 (304.8)	Any	50 (68)	1,150 (5.2)	230 (1.0)	1,380 (6.2)	275 (1.2)
		6-1/4 (158.8)			Perpendicular to wall toward minimum edge		1,700 (7.7)	340 (1.5)	2,040 (9.2)	410 (1.8)
					Parallel to wall edge		3,525 (15.9)	705 (3.2)	4,230 (19.0)	845 (3.8)

1. Tabulated load values are for anchors installed in minimum 6-inch wide, minimum Grade N, Type II, lightweight, medium-weight or normal-weight concrete masonry units conforming to ASTM C 90. Mortar must be minimum Type N. Masonry compressive strength must be at the specified minimum at the time of installation.
2. Allowable load capacities listed are calculated using an applied safety factor of 5.0. Consideration of safety factors of 10 or higher may be necessary depending upon the application such as life safety.
3. Anchors must be installed in the grouted cells and the minimum edge and end distances must be maintained.
4. The tabulated values are applicable for anchors installed in top of grouted masonry walls at a critical spacing distance, s_c, between anchors of 16 times the anchor diameter.

MECHANICAL ANCHORS

POWER-STUD® + SD1
Wedge Expansion Anchor

STRENGTH DESIGN (SD)

Power-Stud+ SD1 Anchor Installation Specifications in Concrete¹

CODE LISTED
ICC-ES ESR-2818



Anchor Property / Setting Information	Notation	Units	Nominal Anchor Diameter										
			1/4 inch	3/8 inch	1/2 inch		5/8 inch		3/4 inch		7/8 inch	1 inch	1-1/4 inch
Anchor diameter	d_a (d_o) ²	in. (mm)	0.250 (6.4)	0.375 (9.5)	0.500 (12.7)		0.625 (15.9)		0.750 (19.1)		0.875 (22.2)	1.000 (25.4)	1.250 (31.8)
Minimum diameter of hole clearance in fixture	d_h	in. (mm)	5/16 (7.5)	7/16 (11.1)	9/16 (14.3)		11/16 (17.5)		13/16 (20.6)		1 (25.4)	1-1/8 (28.6)	1-3/8 (34.9)
Nominal drill bit diameter	d_{bit}	in. (ANSI)	1/4 ANSI	3/8 ANSI	1/2 ANSI		5/8 ANSI		3/4 ANSI		7/8 ANSI	1 ANSI	1-1/4 ANSI
Nominal embedment depth	h_{nom}	in. (mm)	1-3/4 (44)	2-3/8 (60)	2-1/2 (64)		3-3/4 (95)		3-3/8 (86) 4-5/8 (117)		4 (102) 5-5/8 (143)	4-1/2 (114) 5-1/2 (140)	6-1/2 (165)
Effective embedment depth	h_{ef}	in. (mm)	1.50 (38)	2.00 (51)	2.00 (51)		3.25 (83)		2.75 (70) 4.00 (102)		3.125 (79) 4.75 (114)	3.50 (89) 4.375 (111)	5.375 (137)
Minimum hole depth	h_{hole}	in. (mm)	1-7/8 (48)	2-1/2 (64)	2-3/4 (70)		4 (102)		3-3/4 (95) 5 (127)		4-1/4 (108) 5-7/8 (149)	4-7/8 (124) 5-7/8 (149)	7-1/4 (184)
Minimum overall anchor length ²	$anch$	in. (mm)	2-1/4 (57)	3 (76)	3-3/4 (95)		4-1/2 (114)		4-1/2 (114) 6 (152)		5-1/2 (140) 7 (178)	8 (203) 9 (229)	9 (229)
Installation torque ⁵	T_{inst}	ft.-lbf. (N-m)	4 (5)	20 (27)	40 (54)		80 (108)		110 (149)		175 (237)	225 (305)	375 (508)
Torque wrench/socket size	-	in.	7/16	9/16	3/4		15/16		1-1/8		1-5/16	1-1/2	1-7/8
Nut height	-	in.	7/32	21/64	7/16		35/64		41/64		3/4	55/64	1-1/16

Anchors Installed in Concrete Construction³

Minimum member thickness	h_{min}	in. (mm)	3-1/4 (83)	3-3/4 (95)		4 (102)		4 (102)		6 (152)		6 (152) 7 (178)		6 (152) 10 (254)		10 (254) 10 (254)		10 (254) 12 (305)	
Minimum edge distance	c_{min}	in. (mm)	1-3/4 (45)	6 (152)	2-3/4 (70)	2-1/4 (57)	6 (152)	3-1/4 (95)	4 (102)	2-3/4 (70)	6 (152)	5-1/2 (140)	4-1/4 (108)	5 (127)	6 (152)	7 (178)	8 (203)	8 (203)	8 (203)
Minimum spacing distance	s_{min}	in. (mm)	2-1/4 (57)	3-1/2 (89)	9 (229)	3-3/4 (95)	4-1/2 (114)	10 (254)	5 (127)	6 (152)	6 (152)	11 (279)	4-1/4 (108)	6 (152)	6-1/2 (165)	6-1/2 (165)	8 (203)	8 (203)	8 (203)
Critical edge distance (uncracked concrete only)	c_{ac}	in. (mm)	3-1/2 (89)	6-1/2 (165)		8 (203)		8 (203)		6 (152)		10 (254)		11 (279)	16 (406)	11-1/2 (292)	12 (305)	20 (508)	20 (508)

Anchors Installed in the Topside of Concrete-filled Steel Deck Assemblies⁴

Minimum member topping thickness	$h_{min,deck}$	in. (mm)	3-1/4 (83)	3-1/4 (83)		3-1/4 (83)													
Minimum edge distance	$c_{min,deck,top}$	in. (mm)	1-3/4 (45)	2-3/4 (70)		4-1/2 (114)													
Minimum spacing distance	$s_{min,deck,top}$	in. (mm)	2-1/4 (57)	4 (102)		6-1/2 (165)		See note 3		See note 3		See note 3		See note 3		See note 3		See note 3	
Critical edge distance (uncracked concrete only)	$c_{ac,deck,top}$	in. (mm)	3-1/2 (89)	6-1/2 (165)		6 (152)													

Anchors Installed Through the Soffit of Steel Deck Assemblies into Concrete^{6,7}

Minimum member topping thickness (see detail in Figure 2A)	$h_{min,deck}$	in. (mm)	Not Applicable	3-1/4 (95)		3-1/4 (95)		3-1/4 (95)		3-1/4 (95)									
Minimum edge distance, lower flute (see detail in Figure 2A)	c_{min}	in. (mm)		1-1/4 (32)		1-1/4 (32)		1-1/4 (32)		1-1/4 (32)									
Minimum axial spacing distance along flute (see detail in Figure 2A)	s_{min}	in. (mm)		6-3/4 (171)		6-3/4 (171)		9-3/4 (248)		8-1/4 (210) 12 (305)		9-3/8 (238) 14-1/4 (362)							
Minimum member topping thickness (see detail in Figure 2B)	$h_{min,deck}$	in. (mm)		2-1/4 (57)		2-1/4 (57)													
Minimum edge distance, lower flute (see detail in Figure 2B)	c_{min}	in. (mm)		3/4 (19)		3/4 (19)				Not Applicable		Not Applicable							
Minimum axial spacing distance along flute (see detail in Figure 2B)	s_{min}	in. (mm)		6 (152)		6 (152)		9-3/4 (248)											

For SI: 1 inch = 25.4 mm, 1 ft-lbf = 1.356 N-m.

- The information presented in this table is to be used in conjunction with the design criteria of ACI 318 Appendix D.
- The listed minimum overall anchor length is based on anchor sizes commercially available at the time of publication compared with the requirements to achieve the minimum nominal embedment depth, nut height and washer thickness, and consideration of a possible fixture attachment.
- The 1/4 -inch-diameter (6.4 mm) anchors may be installed in the topside of uncracked concrete-filled steel deck assemblies where concrete thickness above the upper flute meets the minimum member thicknesses specified in this table. The 3/8 -inch (9.5 mm) through 1-1/4 -inch-diameter (31.8 mm) anchors may be installed in the topside of cracked and uncracked concrete-filled steel deck assemblies where concrete thickness above the upper flute meets the minimum member thicknesses specified in this table.
- For installations in the topside of concrete-filled steel deck assemblies, see the installation detail in Figure 1.
- For installations through the soffit of steel deck assemblies into concrete, see the installation details in Figures 2A and 2B. In accordance with the figures, anchors shall have an axial spacing along the flute equal to the greater of $3h_{ef}$ or 1.5 times the flute width.
- For installation of 5/8 -inch diameter anchors through the soffit of the steel deck into concrete, the installation torque is 50 ft.-lbf. For installation of 3/4 -inch-diameter anchors through the soffit of the steel deck into concrete, installation torque is 80 ft.-lbf.
- The notation in brackets is for the 2006 IBC.

MECHANICAL ANCHORS

POWER-STUD® + SD1

Wedge Expansion Anchor

Power-Stud+ SD1 Anchor Detail

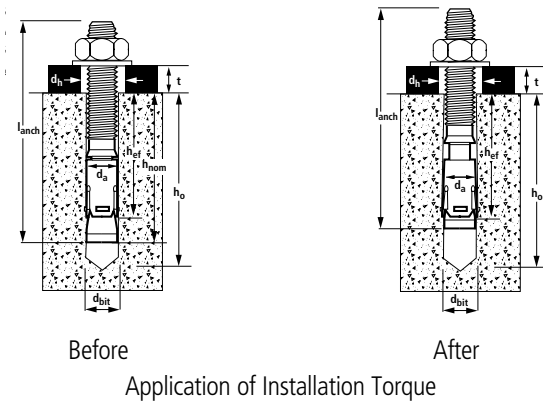

Interpolation of Minimum Edge Distance and Anchor Spacing

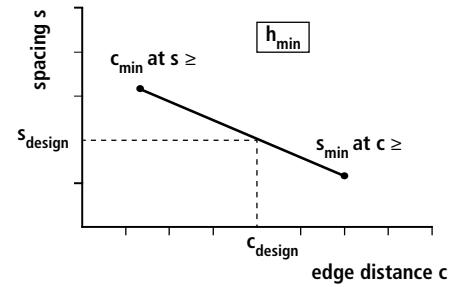

This interpolation applies to the cases when two sets of minimum edge distances, c_{min} , and minimum spacing distances, s_{min} , are given in the SD Installation Specifications for Concrete for a given anchor diameter under the same effective embedment depth, h_{ef} , and corresponding minimum member thickness, h_{min} .

Figure 1 - Power-Stud+ SD1 Installation Detail for Anchors in the Topside Of Concrete Filled Steel Deck Floor and Roof Assemblies (See Dimensional Profile Requirements)

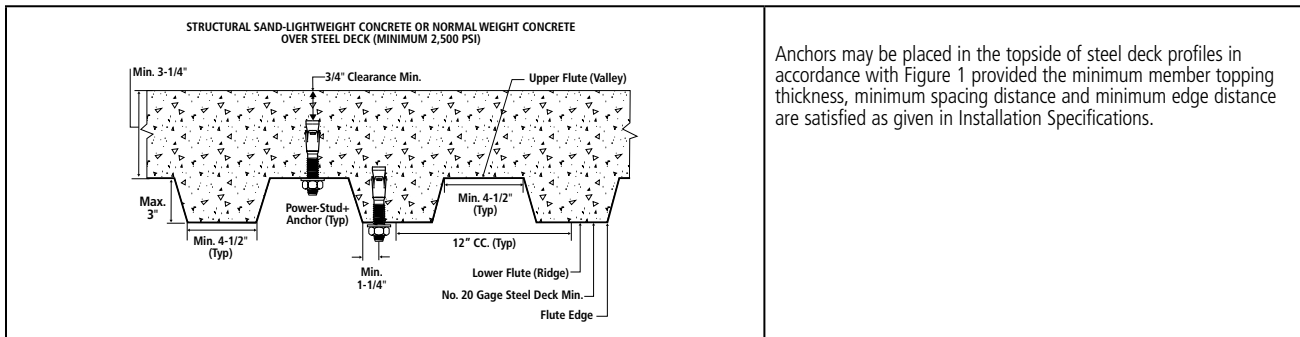

Figure 2A - Power-Stud+ SD1 Installation Detail for Anchors in the Soffit Of Concrete Over Steel Deck Floor and Roof Assemblies (See Dimensional Profile Requirements)

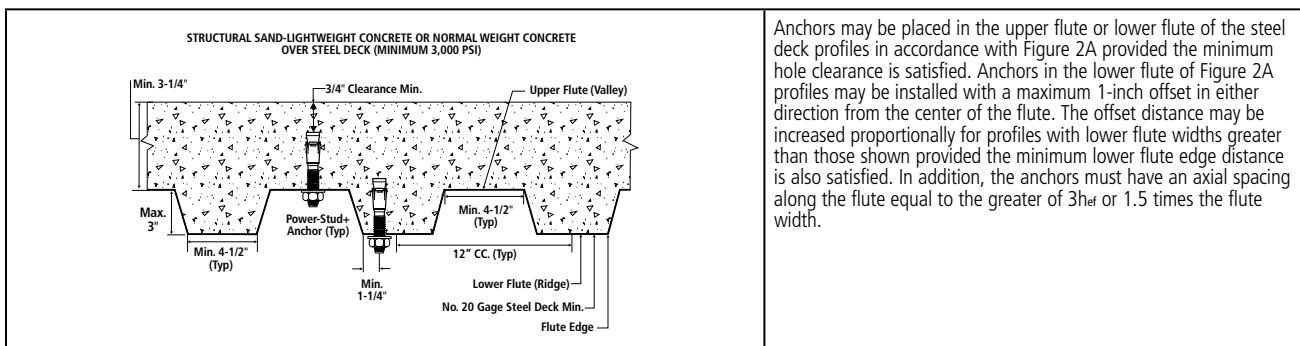
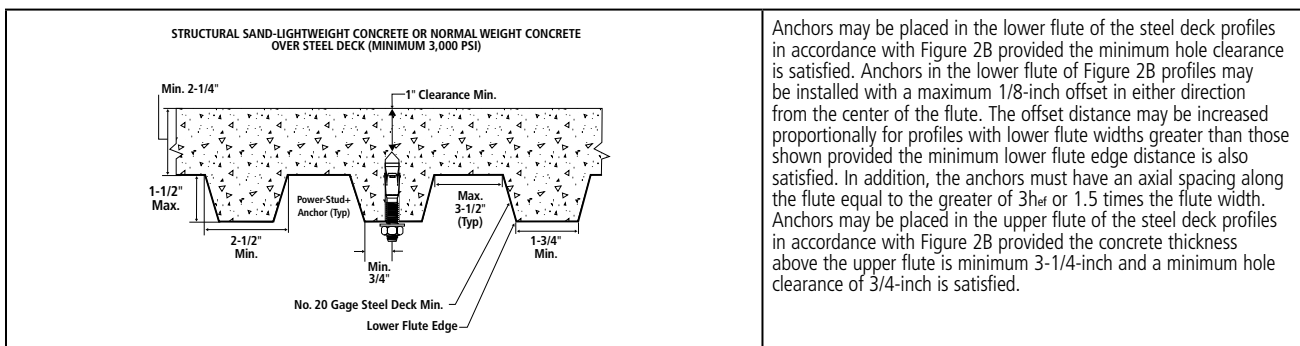

Figure 2B - Power-Stud+ SD1 Installation Detail for Anchors in the Soffit Of Concrete Over Steel Deck Floor and Roof Assemblies (See Dimensional Profile Requirements)



Tension Design Information for Power-Stud+ SD1 Anchor in Concrete
(For use with load combinations taken from ACI 318, Section 9.2)^{1,2}

CODE LISTED
ICC-ES ESR-2818



Design Characteristic	Notation	Units	Nominal Anchor Diameter										
			1/4 inch	3/8 inch	1/2 inch	5/8 inch	3/4 inch	7/8 inch	1 inch	1-1/4 inch			
Anchor category	1, 2 or 3	-	1	1	1	1	1	1	1	1	1		
STEEL STRENGTH IN TENSION⁴													
Minimum specified yield strength	f_{ya}	ksi (N/mm ²)	88.0 (606)	88.0 (606)	80.0 (551)	80.0 (551)	64.0 (441)	58.0 (400)	58.0 (400)	58.0 (400)	58.0 (400)		
Minimum specified ultimate tensile strength (neck)	f_{uta}^{12}	ksi (N/mm ²)	110.0 (758)	110.0 (758)	100.0 (689)	100.0 (689)	80.0 (552)	75.0 (517)	75.0 (517)	75.0 (517)	75.0 (517)		
Effective tensile stress area (neck)	$A_{se,N}$ [A_{se}] ¹³	in ² (mm ²)	0.0220 (14.2)	0.0531 (34.3)	0.1018 (65.7)	0.1626 (104.9)	0.2376 (150.9)	0.327 (207.5)	0.430 (273.1)	0.762 (484)	0.762 (484)		
Steel strength in tension ⁴	N_{sa}^{12}	lb (kN)	2,255 (10.0)	5,455 (24.3)	9,080 (40.4)	14,465 (64.3)	19,000 (84.5)	24,500 (109.0)	32,250 (143.5)	56,200 (250)	56,200 (250)		
Reduction factor for steel strength ³	ϕ	-	0.75										
CONCRETE BREAKOUT STRENGTH IN TENSION⁵													
Effective embedment depth	h_{ef}	in. (mm)	1.50 (38)	2.00 (51)	2.00 (51)	3.25 (83)	2.75 (70)	4.00 (102)	3.125 (79)	4.75 (114)	3.50 (89)	4.375 (111)	5.375 (137)
Effectiveness factor for uncracked concrete	k_{uncr}	-	24	24	24	24	24	24	24	24	24	24	27
Effectiveness factor for cracked concrete	k_{cr}	-	Not Applicable	17	17	17	17	21	17	21	24	24	24
Modification factor for cracked and uncracked concrete ⁵	$\Psi_{c,N}^{12}$	-	1.0	1.0	1.0	1.0	1.0	1.0	1.0	1.0	1.0	1.0	1.0
Critical edge distance (uncracked concrete only)	c_{ac}	in. (mm)	See Installation Specifications										
Reduction factor for concrete breakout strength ³	ϕ	-	0.65 (Condition B)										
PULLOUT STRENGTH IN TENSION (NON SEISMIC-APPLICATIONS)^{6,9}													
Characteristic pullout strength, uncracked concrete (2,500 psi) ⁶	$N_{p,uncr}$	lb (kN)	See note 7	2,865 (12.8)	3,220 (14.3)	5,530 (24.6)	See note 7	See note 7	See note 7	See note 7	See note 7	See note 7	See note 7
Characteristic pullout strength, cracked concrete (2,500 psi) ⁶	$N_{p,cr}$	lb (kN)	Not Applicable	2,035 (9.1)	See note 7	2,505 (11.2)	See note 7	4,450 (19.8)	See note 7	See note 7	See note 7	See note 7	11,350 (50.5)
Reduction factor for pullout strength ³	ϕ	-	0.65 (Condition B)										
PULLOUT STRENGTH IN TENSION FOR SEISMIC APPLICATIONS^{6,9}													
Characteristic pullout strength, seismic (2,500 psi) ^{6,10}	$N_{p,eq}^{12}$	lb (kN)	Not Applicable	2,035 (9.1)	See note 7	2,505 (11.2)	See note 7	4,450 (19.8)	See note 7	See note 7	See note 7	See note 7	11,350 (50.5)
Reduction factor for pullout strength, seismic ³	ϕ	-	0.65 (Condition B)										
PULLOUT STRENGTH IN TENSION FOR ANCHORS INSTALLED THROUGH THE SOFFIT OF SAND-LIGHTWEIGHT AND NORMAL-WEIGHT CONCRETE OVER STEEL DECK													
Characteristic pullout strength, uncracked concrete over steel deck (Figure 2A) ^{6,11}	$N_{p,deck,uncr}$	lb (kN)	Not Applicable	1,940 (8.6)	3,205 (14.2)	2,795 (12.4)	3,230 (14.4)	Not Applicable	Not Applicable	Not Applicable	Not Applicable	Not Applicable	
Characteristic pullout strength, cracked concrete over steel deck (Figure 2A) ^{6,11}	$N_{p,deck,cr}$	lb (kN)		1,375 (6.1)	2,390 (10.6)	1,980 (8.8)	2,825 (12.4)						
Characteristic pullout strength, cracked concrete over steel deck, seismic (Figure 2A) ^{6,11}	$N_{p,deck,eq}$	lb (kN)		1,375 (6.1)	2,390 (10.6)	1,980 (8.8)	2,825 (12.4)						
Characteristic pullout strength, uncracked concrete over steel deck (Figure 2B) ^{6,11}	$N_{p,deck,uncr}$	lb (kN)		1,665 (7.4)	1,900 (8.5)	Not Applicable	Not Applicable						
Characteristic pullout strength, cracked concrete over steel deck (Figure 2B) ^{6,11}	$N_{p,deck,cr}$	lb (kN)		1,180 (5.2)	1,420 (6.3)								
Characteristic pullout strength, cracked concrete over steel deck, seismic (Figure 2B) ^{6,11}	$N_{p,deck,eq}$	lb (kN)		1,180 (5.2)	1,420 (6.3)								
Reduction factor for pullout strength, steel deck ³	ϕ	-	0.65 (Condition B)										

For SI: 1 inch = 25.4 mm; 1 ksi = 6.894 N/mm²; 1 lbf = 0.0044 kN.

- The data in this table is intended to be used with the design provisions of ACI 318 Appendix D; for anchors resisting seismic load combinations the additional requirements of ACI 318 D.3.3 must apply.
- Installation must comply with published instructions and details.
- All values of ϕ apply to the load combinations of IBC Section 1605.2.1 or ACI 318 Section 9.2. If the load combinations of ACI 318 Appendix C are used, then the appropriate value of ϕ must be determined in accordance with ACI 318-11 D.4.4 (ACI 318-08 and -05 D.4.5). For reinforcement that meets ACI 318 Appendix D requirements for Condition A, see ACI 318-11 D.4.3 (ACI 318-08 and -05 D.4.4) for the appropriate ϕ factor when the load combinations of IBC Section 1605.2 or ACI 318 Section 9.2 are used.
- The Power-Stud+ SD1 is considered a ductile steel element as defined by ACI 318 D.1. Tabulated values for steel strength in tension are based on test results per ACI 355.2 and must be used for design.
- For all design cases use $\Psi_{c,N} = 1.0$. The appropriate effectiveness factor for cracked concrete (k_{cr}) or uncracked concrete (k_{uncr}) must be used.
- For all design cases use $\Psi_{c,p} = 1.0$. For the calculation of N_{pn} , see Section 4.1.4 of ESR-2818.
- Pullout strength does not control design of indicated anchors. Do not calculate pullout strength for indicated anchor size and embedment.
- Anchors are permitted to be used in sand-lightweight concrete provided that the modification factor λ_a (ACI 318-11) or λ (ACI 318-08) for concrete breakout strength is taken as 0.6 in lieu of ACI 318-11 D.3.6 (2012 IBC) or ACI 318-08 D.3.4 (2009 IBC). In addition, the pullout strength $N_{p,cr}$, $N_{p,eq}$, $N_{p,uncr}$ must be multiplied by 0.6, as applicable. For ACI 318-05, the values N_b , $N_{p,eq}$, $N_{p,cr}$, $N_{p,uncr}$ and V_b must be multiplied by 0.6. For anchors installed in the soffit of sand-lightweight concrete-filled steel deck and roof assemblies, as shown in Figure 2A and Figure 2B, this reduction is not required.
- For anchors in the topside of concrete-filled steel deck assemblies, see Figure 1.
- Tabulated values for characteristic pullout strength in tension are for seismic applications and based on test results in accordance with ACI 355.2, Section 9.5.
- Values for $N_{p,deck}$ are for sand-lightweight concrete ($f'_{c, min} = 3,000$ psi) and additional lightweight concrete reduction factors need not be applied. In addition, evaluation for the concrete breakout capacity in accordance with ACI 318 D.5.2 is not required for anchors installed in the deck soffit (flute).
- For 2003 IBC, f_{uta} replaces f_{ut} ; N_{sa} replaces N_s ; $\Psi_{c,N}$ replaces Ψ_s ; and $N_{p,eq}$ replaces $N_{p,seis}$.
- The notation in brackets is for the 2006 IBC.

MECHANICAL ANCHORS

POWER-STUD[®] + SD1

Wedge Expansion Anchor

Shear Design Information for Power-Stud+ SD1 Anchor in Concrete
(For use with load combinations taken from ACI 318, Section 9.2)^{1,2}

CODE LISTED
ICC-ES ESR-2818



Design Characteristic	Notation	Units	Nominal Anchor Diameter										
			1/4 inch	3/8 inch	1/2 inch	5/8 inch	3/4 inch	7/8 inch	1 inch	1-1/4 inch			
Anchor category	1, 2 or 3	-	1	1	1	1	1	1	1	1	1	1	1
STEEL STRENGTH IN SHEAR⁴													
Minimum specified yield strength (threads)	f_{ya}	ksi (N/mm ²)	70.0 (482)	80.0 (552)	70.4 (485)	70.4 (485)	64.0 (441)	58.0 (400)	58.0 (400)	58.0 (400)	58.0 (400)	58.0 (400)	58.0 (400)
Minimum specified ultimate strength (threads)	f_{uta}^{11}	ksi (N/mm ²)	88.0 (606)	100.0 (689)	88.0 (607)	88.0 (607)	80.0 (552)	75.0 (517)	75.0 (517)	75.0 (517)	75.0 (517)	75.0 (517)	75.0 (517)
Effective tensile stress area (threads)	$A_{se,V}$ [A _{se}] ¹²	in ² (mm ²)	0.0318 (20.5)	0.0775 (50.0)	0.1419 (91.5)	0.2260 (145.8)	0.3345 (212.4)	0.462 (293.4)	0.6060 (384.8)	0.969 (615)	0.6060 (384.8)	0.969 (615)	0.969 (615)
Steel strength in shear ⁵	V_{sa}^{11}	lb (kN)	925 (4.1)	2,990 (13.3)	4,620 (20.6)	9,030 (40.2)	10,640 (47.3)	11,655 (54.8)	8,820 (39.2)	10,935 (48.6)	17,750 (79.0)	17,750 (79.0)	17,750 (79.0)
Reduction factor for steel strength ³	ϕ	-	0.65										
CONCRETE BREAKOUT STRENGTH IN SHEAR^{6,7}													
Load bearing length of anchor (h_{ef} or $8d_a$, whichever is less)	l_e^{11}	in. (mm)	1.50 (38)	2.00 (51)	2.00 (51)	3.25 (83)	2.75 (70)	4.00 (102)	3.125 (79)	4.75 (114)	3.50 (88.9)	4.375 (111)	5.375 (137)
Nominal anchor diameter	d_a [d _a] ¹²	in. (mm)	0.250 (6.4)	0.375 (9.5)	0.500 (12.7)	0.625 (15.9)	0.750 (19.1)	0.875 (22.2)	1.000 (25.4)	1.25 (31.8)	1.000 (25.4)	1.25 (31.8)	1.25 (31.8)
Reduction factor for concrete breakout ³	ϕ	-	0.70 (Condition B)										
PRYOUT STRENGTH IN SHEAR^{6,7}													
Coefficient for prout strength (1.0 for $h_{ef} < 2.5$ in., 2.0 for $h_{ef} \geq 2.5$ in.)	k_{cp}	-	1.0	1.0	1.0	2.0	2.0	2.0	2.0	2.0	2.0	2.0	2.0
Effective embedment	h_{ef}	in. (mm)	1.50 (38)	2.00 (51)	2.00 (51)	3.25 (83)	2.75 (70)	4.00 (102)	3.125 (79)	4.75 (114)	3.50 (88.9)	4.375 (111)	5.375 (137)
Reduction factor for prout strength ³	ϕ	-	0.70 (Condition B)										
STEEL STRENGTH IN SHEAR FOR SEISMIC APPLICATIONS													
Steel strength in shear, seismic ⁸	$V_{sa,eq}^{11}$	lb (kN)	N/A	2,440 (10.9)	3,960 (17.6)	6,000 (26.7)	8,580 (38.2)	9,635 (42.9)	8,820 (39.2)	9,845 (43.8)	17,750 (79.0)	17,750 (79.0)	17,750 (79.0)
Reduction factor for steel strength in shear for seismic ³	ϕ	-	0.65										
STEEL STRENGTH IN SHEAR FOR FOR ANCHORS INSTALLED THROUGH THE SOFFIT OF SAND-LIGHTWEIGHT AND NORMAL-WEIGHT CONCRETE OVER STEEL DECK^{9,10}													
Steel strength in shear, concrete over steel deck (Figure 2A) ⁹	$V_{sa,deck}$	lb (kN)	Not Applicable	2,120 (9.4)	2,290 (10.2)	3,710 (16.5)	5,505 (24.5)	Not Applicable	Not Applicable	Not Applicable	Not Applicable	Not Applicable	Not Applicable
Steel strength in shear, concrete over steel deck, seismic (Figure 2A) ⁹	$V_{sa,deck,eq}$	lb (kN)		2,120 (9.4)	2,290 (10.2)	3,710 (16.5)	4,570 (20.3)						
Steel strength in shear, concrete over steel deck (Figure 2B) ⁹	$V_{sa,deck}$	lb (kN)		2,120 (9.4)	2,785 (12.4)	Not Applicable	Not Applicable						
Steel strength in shear, concrete over steel deck, seismic (Figure 2B) ⁹	$V_{sa,deck,eq}$	lb (kN)		2,120 (9.4)	2,785 (12.4)								
Reduction factor for steel strength in shear, steel deck ³	ϕ	-	0.65										

For Sl: 1 inch = 25.4 mm; 1 ksi = 6.894 N/mm²; 1 lbf = 0.0044 kN.

- The data in this table is intended to be used with the design provisions of ACI 318 Appendix D; for anchors resisting seismic load combinations the additional requirements of ACI 318 D.3.3 must apply.
- Installation must comply with published instructions and details.
- All values of ϕ were determined from the load combinations of IBC Section 1605.2 or ACI 318 Section 9.2. If the load combinations of ACI 318 Appendix C are used, then the appropriate value of ϕ must be determined in accordance with ACI 318-11 D.4.4 (ACI 318-08 and -05 D.4.4). For reinforcement that meets ACI 318 Appendix D requirements for Condition A, see ACI 318-11 D.4.3 (ACI 318-08 and -05 D.4.4) for the appropriate ϕ factor when the load combinations of IBC Section 1605.2 or ACI 318 Section 9.2 are used.
- The Power-Stud+ SD1 is considered a ductile steel element as defined by ACI 318 D.1.
- Tabulated values for steel strength in shear must be used for design. These tabulated values are lower than calculated results using equation D-20 in ACI 318-08 (ACI 318-05).
- Anchors are permitted to be used in sand-lightweight concrete provided that the modification factor λ_a (ACI 318-11) or λ (ACI 318-08) for concrete breakout strength is taken as 0.6 in lieu of ACI 318-11 D.3.6 (2012 IBC) or ACI 318-08 D.3.4 (2009 IBC). In addition, the pullout strength $N_{p,cr}$, $N_{p,eq}$, $N_{p,unbr}$ must be multiplied by 0.6, as applicable. For ACI 318-05, the values N_b , $N_{p,eq}$, $N_{p,cr}$, $N_{p,unbr}$ and V_b must be multiplied by 0.6. For anchors installed in the soffit of sand-lightweight concrete-filled steel deck and roof assemblies, as shown in Figure 2A and Figure 2B, this reduction is not required.
- For anchors in the topside of concrete-filled steel deck assemblies, see Figure 1.
- Tabulated values for steel strength in shear are for seismic applications and based on test results in accordance with ACI 355.2, Section 9.6.
- Tabulated values for $V_{sa,deck}$ and $V_{sa,deck,eq}$ are for sand-lightweight concrete ($f'_{c,min} = 3,000$ psi); additional lightweight concrete reduction factors need not be applied. In addition, evaluation for the concrete breakout capacity in accordance with ACI 318 D.6.2 and the prout capacity in accordance with ACI 318 D.6.3 are not required for anchors installed in the deck soffit (flute).
- Shear loads for anchors installed through steel deck into concrete may be applied in any direction.
- For the 2003 IBC f_{uta} replaces f_{ut} ; V_{sa} replaces V_s ; l_e replaces l ; and $V_{sa,eq}$ replaces $V_{sa,seis}$.
- The notation in brackets is for the 2006 IBC.

Factored design strength ϕN_n and ϕV_n
Calculated in accordance with ACI 318 Appendix D
Compliant with the International Building Code



Tension and Shear Design Strengths for Power-Stud+ SD1 in Cracked Concrete¹⁻⁶

Nominal Anchor Diameter (in.)	Nominal Embed. h_{nom} (in.)	Minimum Concrete Compressive Strength									
		$f'_c = 2,500$ psi		$f'_c = 3,000$ psi		$f'_c = 4,000$ psi		$f'_c = 6,000$ psi		$f'_c = 8,000$ psi	
		ϕN_n Tension (lbs.)	ϕV_n Shear (lbs.)	ϕN_n Tension (lbs.)	ϕV_n Shear (lbs.)	ϕN_n Tension (lbs.)	ϕV_n Shear (lbs.)	ϕN_n Tension (lbs.)	ϕV_n Shear (lbs.)	ϕN_n Tension (lbs.)	ϕV_n Shear (lbs.)
1/4	1-3/4	-	-	-	-	-	-	-	-	-	-
3/8	2-3/8	1,325	1,685	1,450	1,845	1,675	1,945	2,050	1,945	2,365	1,945
1/2	2-1/2	1,565	1,685	1,710	1,845	1,975	2,130	2,420	2,605	2,795	3,005
	3-3/4	1,630	3,005	1,785	3,005	2,060	3,005	2,520	3,005	2,915	3,005
5/8	3-3/8	2,520	3,125	2,760	3,425	3,185	3,955	3,905	4,845	4,505	5,590
	4-5/8	2,895	5,870	3,170	5,870	3,660	5,870	4,480	5,870	5,175	5,870
3/4	4	3,770	6,210	4,130	6,800	4,770	6,915	5,840	6,915	6,735	6,915
	5-5/8	5,720	7,575	6,265	7,575	7,235	7,575	8,860	7,575	10,230	7,575
7/8	4-1/2	4,470	5,735	4,895	5,735	5,655	5,735	6,925	5,735	7,995	5,735
1	5-1/2	7,140	7,110	7,820	7,110	9,030	7,110	11,060	7,110	12,770	7,110
1-1/4	6-1/2	7,380	11,540	8,080	11,540	9,330	11,540	11,430	11,540	13,195	11,540

■ - Anchor Pullout/Pryout Strength Controls
 ■ - Concrete Breakout Strength Controls
 ■ - Steel Strength Controls

Tension and Shear Design Strengths for Power-Stud+ SD1 in Uncracked Concrete¹⁻⁶

Nominal Anchor Diameter (in.)	Nominal Embed. h_{nom} (in.)	Minimum Concrete Compressive Strength									
		$f'_c = 2,500$ psi		$f'_c = 3,000$ psi		$f'_c = 4,000$ psi		$f'_c = 6,000$ psi		$f'_c = 8,000$ psi	
		ϕN_n Tension (lbs.)	ϕV_n Shear (lbs.)	ϕN_n Tension (lbs.)	ϕV_n Shear (lbs.)	ϕN_n Tension (lbs.)	ϕV_n Shear (lbs.)	ϕN_n Tension (lbs.)	ϕV_n Shear (lbs.)	ϕN_n Tension (lbs.)	ϕV_n Shear (lbs.)
1/4	1-3/4	1,435	600	1,570	600	1,690	600	1,690	600	1,690	600
3/8	2-3/8	1,860	1,945	2,040	1,945	2,335	1,945	2,885	1,945	3,330	1,945
1/2	2-1/2	2,095	2,375	2,295	2,605	2,645	3,005	3,240	3,005	3,745	3,005
	3-3/4	3,595	3,005	3,940	3,005	4,545	3,005	5,570	3,005	6,430	3,005
5/8	3-3/8	3,555	4,375	3,895	4,795	4,500	5,535	5,510	5,870	6,365	5,870
	4-5/8	6,240	5,870	6,835	5,870	7,895	5,870	9,665	5,870	10,850	5,870
3/4	4	4,310	6,915	4,720	6,915	5,450	6,915	6,675	6,915	7,710	6,915
	5-5/8	8,075	7,575	8,845	7,575	10,215	7,575	12,510	7,575	14,250	7,575
7/8	4-1/2	5,105	5,735	5,595	5,735	6,460	5,735	7,910	5,735	9,135	5,735
1	5-1/2	7,140	7,110	7,820	7,110	9,030	7,110	11,060	7,110	12,770	7,110
1-1/4	6-1/2	10,935	11,540	11,980	11,540	13,830	11,540	16,940	11,540	19,560	11,540

■ - Anchor Pullout/Pryout Strength Controls
 ■ - Concrete Breakout Strength Controls
 ■ - Steel Strength Controls

- Tabular values are provided for illustration and are applicable for single anchors installed in normal-weight concrete with minimum slab thickness, $h_a = h_{min}$, and with the following conditions:
 - c_{a1} is greater than or equal to the critical edge distance, c_{ac} (table values based on $c_{a1} = c_{ac}$).
 - c_{a2} is greater than or equal to 1.5 times c_{a1} .
- Calculations were performed according to ACI 318-11 Appendix D. The load level corresponding to the controlling failure mode is listed. (e.g. For tension: steel, concrete breakout and pullout; For shear: steel, concrete breakout and pryout). Furthermore, the capacities for concrete breakout strength in tension and pryout strength in shear are calculated using the effective embedment values, h_{ef} , for the selected anchors as noted in the design information tables. Please also reference the installation specifications for more information.
- Strength reduction factors (ϕ) were based on ACI 318 Section 9.2 for load combinations. Condition B is assumed.
- Tabular values are permitted for static loads only, seismic loading is not considered with these tables.
- For designs that include combined tension and shear, the interaction of tension and shear loads must be calculated in accordance with ACI 318 Appendix D.
- Interpolation is not permitted to be used with the tabular values. For intermediate base material compressive strengths please see ACI 318 Appendix D. For other design conditions including seismic considerations please see ACI 318 Appendix D.

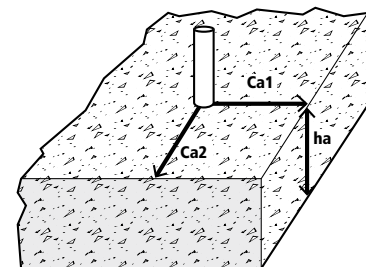

ORDERING INFORMATION

Power-Stud+ SD1 (Carbon Steel Body and Expansion Clip)

Cat. No.	Anchor Size	Thread Length	Box Qty.	Carton Qty.	Wt. /100 (lbs.)	ANSI Carbide Drill Bit Cat. No.				
						SDS-Plus		SDS-Max	Spline	
						Fathead	SDS-Plus/S-4 Plus	4-X Cutter SDS-Max	4-X Cutter Head Spline	Single Tip Spline
7400SD1	1/4" x 1-3/4"	3/4"	100	600	3	00711	00320	-	-	-
7402SD1	1/4" x 2-1/4"	1-1/4"	100	600	4	00713	00321	-	-	-
7404SD1	1/4" x 3-1/4"	2-1/4"	100	600	5	00713	00321	-	-	-
7410SD1	3/8" x 2-1/4"	7/8"	50	300	8	00727	00333	-	-	01401
7412SD1	3/8" x 2-3/4"	1-3/8"	50	300	9	00727	00333	-	-	01401
7413SD1	3/8" x 3"	1-5/8"	50	300	10	00727	00333	-	-	01401
7414SD1	3/8" x 3-1/2"	2-1/8"	50	300	12	00727	00333	-	-	01402
7415SD1	3/8" x 3-3/4"	2-3/8"	50	300	13	00727	00333	-	-	01402
7416SD1	3/8" x 5"	3-5/8"	50	300	15	00729	00334	-	-	01402
7417SD1	3/8" x 7"	5-5/8"	50	300	21	00729	00334	-	-	01403
7420SD1	1/2" x 2-3/4"	1"	50	200	19	00739	00346	08801	-	01407
7422SD1	1/2" x 3-3/4"	2"	50	200	23	00739	00346	08801	-	01407
7423SD1	1/2" x 4-1/2"	2-3/4"	50	200	27	00741	00348	08801	-	01407
7424SD1	1/2" x 5-1/2"	3-3/4"	50	150	30	00741	00348	08801	-	01408
7426SD1	1/2" x 7"	5-1/4"	25	100	38	00741	00348	08801	-	01408
7427SD1	1/2" x 8-1/2"	6-3/4"	25	100	44	00741	00349	08802	-	01409
7428SD1	1/2" x 10"	8-1/4"	25	100	53	00741	00349	08802	-	01409
7430SD1	5/8" x 3-1/2"	1-1/2"	25	100	37	-	00359	08809	07017	-
7432SD1	5/8" x 4-1/2"	2-1/2"	25	100	43	-	00359	08809	07017	-
7433SD1	5/8" x 5"	3"	25	100	47	-	00359	08809	07017	-
7434SD1	5/8" x 6"	4"	25	75	53	-	00359	08809	07020	-
7436SD1	5/8" x 7"	5"	25	75	60	-	00361	08809	07020	-
7438SD1	5/8" x 8-1/2"	6-1/2"	25	50	70	-	00361	08810	07020	-
7439SD1	5/8" x 10"	8"	25	75	87	-	00361	08810	07020	-
7440SD1	3/4" x 4-1/4"	1-3/4"	20	60	63	-	00368	08817	07031	-
7441SD1	3/4" x 4-3/4"	2-1/4"	20	60	68	-	00368	08817	07031	-
7442SD1	3/4" x 5-1/2"	3"	20	60	76	-	00368	08817	07031	-
7444SD1	3/4" x 6-1/4"	3-3/4"	20	60	83	-	00370	08817	07033	-
7446SD1	3/4" x 7"	4-1/2"	20	60	91	-	00370	08817	07033	-
7448SD1	3/4" x 8-1/2"	6"	10	40	107	-	00370	08818	07033	-
7449SD1	3/4" x 10"	7-1/2"	10	30	123	-	00370	08818	07033	-
7451SD1	3/4" x 12"	9-1/2"	10	30	144	-	00371	08818	07035	-
7450SD1	7/8" x 6"	2-3/4"	10	20	128	-	-	08829	07043	01443
7452SD1	7/8" x 8"	4-3/4"	10	40	161	-	-	08829	07043	01443
7454SD1	7/8" x 10"	6-3/4"	10	30	187	-	-	08830	07043	01443
7461SD1	1" x 6"	2-3/8"	10	30	168	-	-	08833	07049	01449
7463SD1	1" x 9"	5-3/8"	10	30	234	-	-	08834	07049	01449
7465SD1	1" x 12"	8-3/8"	5	15	307	-	-	08834	07051	01450
7473SD1	1-1/4" x 9"	4-3/4"	5	15	374	-	-	08846	07064	01464
7475SD1	1-1/4" x 12"	7-3/4"	5	15	476	-	-	08847	07066	01465



MECHANICAL ANCHORS

POWER-STUD® + SD1
Wedge Expansion Anchor

Tie Wire Power-Stud+ SD1 (Carbon Steel Body and Expansion clip)

Cat. No.	Anchor Size	Thread Length	Box Qty.	Carton Qty.	Wt./100 (lbs.)
7409SD1	1/4" x 2"	N/A	100	500	3



Installation Accessories

Cat. No.	Description	Box Qty
08466	Adjustable torque wrench with 1/2" square drive (25 to 250 ft.-lbs.)	1
08280	Hand pump / dust blower	1



Shaded catalog numbers denote sizes which are less than the minimum standard anchor length for strength design. The published size includes the diameter and the overall length of the anchor. All anchors are packaged with nuts and washers. See the Powers website or Buyers Guide for additional information on carbide drill bits.