

NIPPLES

NIPPLES AND FITTINGS

NIPPLES & FITTINGS



BRASS & BRONZE..... 319-345

Brass Nipples - Sch 40.....	319-325
EH Sch 80.....	WEBSITE
C/P Brass Nipples.....	326-327
Bronze Fittings.....	328-340
Lead Free Bronze Fittings	328-340
C/P Fittings.....	341-342
Bronze Cleanout Plugs	343
Bronze Drop Ear Elbows.....	343
Bronze Barbs for PL. Pipe	344
Steel Barbs for PL. Pipe	344
Lead Free Bronze Barbs for PL. Pipe.....	345
Stainless Steel Barbs for PL. Pipe.....	345
Stainless Steel Well Couplings	345
Stainless Steel Merchant Couplings	345

Single Run	368
Nipple Assortments.....	369

STAINLESS STEEL..... 346-359

Stainless Nipples.....	346-357
Sch 80 SS Nipples	WEBSITE
150# Cast SS Fittings	352-359

BLACK & GALVANIZED

Sch. 40 Welded Steel Nipples.....	360-368
Sch. 80 Seamless Steel nipple.....	370-375
Sch. XXS Seamless Steel Nipple	376
Groove Nipples.....	377-378
Merchant Couplings.....	379
API Line Couplings.....	380
Malleable Fittings.....	381-390
Steel Fittings.....	391-392
300# Malleable	393-394
Bull Plugs and Swages.....	395-396
Forged Steel Fanges	397-398
Companion Flanges	399-400
Blind Flanges.....	400
Copper Fittings.....	401-406

If you don't see what you're looking for, visit www.midlandindustries.com

- Many malleable fittings not listed in the catalog
- Aluminum nipples and fittings
- Tank accessories - duplex tank bushings, double tapped bushings and vent caps
- Sch 40 seamless steel nipples
- Many odd sizes of nipples and fittings not listed in catalog

WARNING: This product can expose you to chemicals, including Nickel, which are known to the State of California to cause cancer. For more information, visit www.P65Warnings.ca.gov



BRASS NIPPLES



We hereby certify that to the best of our knowledge and belief the CDA 230 alloy seamless Red Brass Pipe from which our nipples are produced meet the requirements of ASTM Specifications B43 and is free of mercury contamination. The chemical analysis is 85% copper, 15% Zinc and conforms to federal Specifications WWN-351. Our brass nipples meet ANSI/ASTM B687-96 and MS51846 for standard brass nipples, and MS51872 for extra heavy brass nipples.

Threads: Nipples are threaded with American Standard taper pipe threads (NPT) in accordance with screw-thread standard for Federal Services Handbook H-58. ANSI B1.20.1

This product is certified by NSF to NSF/ANSI 61 for use in drinking water supplies of pH 6.5 and above.

PRICING FILE AVAILABLE ONLINE

- ASTM B43
- ANSI B1.20.1, WW-N-351
- ANSI/ ASTM B687-96
- NSF-61 Approved
- MS51846 STD Brass Nipples
- RoHS compliant

SEE OUR WEBSITE FOR SCH 80 BRASS NIPPLES - EXTRA HEAVY

STANDARD RED BRASS 85% PIPE WITH THREADED ENDS SPECIFICATIONS:

Pipe Size in Inches	Dimension in Inches		
	O.D.	I.D.	Wall Thickness
1/8"	.405	.281	.062
1/4"	.540	.376	.082
3/8"	.675	.495	.090
1/2"	.840	.626	.107
3/4"	1.050	.822	.114
1"	1.315	1.063	.126
1-1/4"	1.660	1.368	.146
1-1/2"	1.900	1.600	.150
2"	2.375	2.063	.156
2-1/2"	2.875	2.501	.187
3"	3.500	3.062	.219
3-1/2"	4.000	3.500	.250
4"	4.500	4.000	.250
4-1/2"	5.000	4.500	.250
5"	5.563	5.063	.250
6"	6.625	6.125	.250

Standard Size (Inches)	Allowable Pressure POUNDS PER SQUARE INCH			
	@ 100° F	@ 200° F	@ 300° F	@ 400° F
1/8"	370	370	320	140
1/4"	870	870	760	330
3/8"	890	890	780	340
1/2"	900	900	790	340
3/4"	810	810	710	310
1"	630	630	560	240
1-1/4"	690	690	610	260
1-1/2"	630	630	560	240
2"	540	540	480	210
2-1/2"	450	450	390	170
3"	510	510	450	190
3-1/2"	570	570	500	220
4"	510	510	440	190
5"	410	410	360	160
6"	340	340	300	130

No-Lead 125LB seamless Threaded Red Brass Nipples - 2200

LEAD FREE



WARNING: This product can expose you to chemicals, including Nickel, which are known to the State of California to cause cancer. For more information, visit www.P65Warnings.ca.gov

SCH 40 SEAMLESS

NIPPLES AND FITTINGS

113RB



1/8" - 27



1/8" DIAMETER SCH 40 SEAMLESS

MIDLAND	AMC	CHAMPION	LENGTH	BOX/CASE	APPROX. WT. LBS.	LIST
40001	80300-02	112RB-A	Close (3/4")	25/400	0.02	
40002	80300-0215	113RB-A15	x 1-1/2"	25/400	0.03	
40003	80300-0220	113RB-A2	x 2"	25/400	0.04	
40004	80300-0225	113RB-A25	x 2-1/2"	25/400	0.05	
40005	80300-0230	113RB-A3	x 3"	25/400	0.06	
40006	80300-0235	113RB-A35	x 3-1/2"	25/400	0.07	
40007	80300-0240	113RB-A4	x 4"	25/400	0.08	
40008	80300-0245	113RB-A45	x 4-1/2"	25/400	0.10	
40009	80300-0250	113RB-A5	x 5"	25/400	0.11	
40010	80300-0255	113RB-A55	x 5-1/2"	25/400	0.12	
40011	80300-0260	113RB-A6	x 6"	25/400	0.13	
40012	80300-0270	113RB-A7	x 7"	25/400	0.15	
40013	80300-0280	113RB-A8	x 8"	25/400	0.17	
40014	80300-0290	113RB-A9	x 9"	25/400	0.19	
40015	80300-0292	113RB-A10	x 10"	25/400	0.21	
40016	80300-0294	113RB-A11	x 11"			
40017	80300-0296	113RB-A12	x 12"	25/400	0.25	
40018			x 14"	1/1	0.29	
40019			x 16"	1/1	0.34	



1/4"-18

1/4" DIAMETER SCH 40 SEAMLESS

MIDLAND	AMC	CHAMPION	LENGTH	BOX/CASE	APPROX. WT. LBS.	LIST
40020	80300-04	112RB-B	Close (7/8")	25/400	0.03	
40021	80300-0415	113RB-B15	x 1-1/2"	25/400	0.05	
40022	80300-0420	113RB-B2	x 2"	25/400	0.07	
40023	80300-0425	113RB-B25	x 2-1/2"	25/400	0.09	
40024	80300-0430	113RB-B3	x 3"	25/400	0.11	
40025	80300-0435	113RB-B35	x 3-1/2"	25/400	0.13	
40026	80300-0440	113RB-B4	x 4"	25/400	0.14	
40027	80300-0445	113RB-B45	x 4-1/2"	25/400	0.16	
40028	80300-0450	113RB-B5	x 5"	25/400	0.18	
40029	80300-0455	113RB-B55	x 5-1/2"	25/400	0.20	
40030	80300-0460	113RB-B6	x 6"	25/400	0.22	
40031	80300-0470	113RB-B7	x 7"	25/200	0.25	
40032	80300-0480	113RB-B8	x 8"	25/200	0.29	
40033	80300-0490	113RB-B9	x 9"	25/200	0.33	
40034	80300-0492	113RB-B10	x 10"	25/200	0.36	
40035	80300-0494	113RB-B11	x 11"	25/200	0.40	
40036	80300-0496	113RB-B12	x 12"	25/200	0.43	

 See page pipe fittings for Yellow Brass Nipples

WARNING: This product can expose you to chemicals, including Nickel, which are known to the State of California to cause cancer. For more information, visit www.P65Warnings.ca.gov

SCH 40 SEAMLESS

NIPPLES AND FITTINGS



3/8"-18

3/8" DIAMETER SCH 40 SEAMLESS

MIDLAND	AMC	CHAMPION	LENGTH	BOX/CASE	APPROX. WT. LBS.	LIST
40040	80300-06	112RB-C	Close (1")	25/400	0.05	
40041	80300-0615	113RB-C15	x 1-1/2"	25/400	0.08	
40042	80300-0620	113RB-C2	x 2"	25/400	0.10	
40043	80300-0625	113RB-C25	x 2-1/2"	25/400	0.13	
40044	80300-0630	113RB-C3	x 3"	25/400	0.16	
40045	80300-0635	113RB-C35	x 3-1/2"	25/400	0.18	
40046	80300-0640	113RB-C4	x 4"	25/400	0.21	
40047	80300-0645	113RB-C45	x 4-1/2"	25/300	0.23	
40048	80300-0650	113RB-C5	x 5"	25/300	0.26	
40049	80300-0655	113RB-C55	x 5-1/2"	25/300	0.29	
40050	80300-0660	113RB-C6	x 6"	25/300	0.31	
40051	80300-0670	113RB-C7	x 7"	25/200	0.36	
40052	80300-0680	113RB-C8	x 8"	25/150	0.42	
40053	80300-0690	113RB-C9	x 9"	25/150	0.47	
40054	80300-0692	113RB-C10	x 10"	25/100	0.52	
40055	80300-0694	113RB-C11	x 11"	25/100	0.57	
40056	80300-0696	113RB-C12	x 12"	25/100	0.62	

113RB



1/2" - 14

1/2" DIAMETER SCH 40 SEAMLESS

MIDLAND	AMC	CHAMPION	LENGTH	BOX/CASE	APPROX. WT. LBS.	LIST
40060	80300-08	112RB-D	Close (1-1/8")	25/400	0.09	
40061	80300-0815	113RB-D15	x 1-1/2"	25/400	0.12	
40062	80300-0820	113RB-D2	x 2"	25/400	0.16	
40063	80300-0825	113RB-D25	x 2-1/2"	25/300	0.20	
40064	80300-0830	113RB-D3	x 3"	25/300	0.23	
40065	80300-0835	113RB-D35	x 3-1/2"	25/300	0.27	
40066	80300-0840	113RB-D4	x 4"	25/200	0.31	
40067	80300-0845	113RB-D45	x 4-1/2"	25/200	0.35	
40068	80300-0850	113RB-D5	x 5"	25/200	0.39	
40069	80300-0855	113RB-D55	x 5-1/2"	25/200	0.43	
40070	80300-0860	113RB-D6	x 6"	25/200	0.47	
40071	80300-0870	113RB-D7	x 7"	25/100	0.55	
40072	80300-0880	113RB-D8	x 8"	25/100	0.62	
40073	80300-0890	113RB-D9	x 9"	25/100	0.70	
40074	80300-0892	113RB-D10	x 10"	25/75	0.78	
40075	80300-0894	113RB-D11	x 11"	25/75	0.86	
40076	80300-0896	113RB-D12	x 12"	25/75	0.94	
40079			x 24"			
40245			x 36"			

WARNING: This product can expose you to chemicals, including Nickel, which are known to the State of California to cause cancer. For more information, visit www.P65Warnings.ca.gov



SCH 40 SEAMLESS

NIPPLES AND FITTINGS

NIPPLES & FITTINGS



3/4" - 14

3/4" DIAMETER SCH 40 SEAMLESS

MIDLAND	AMC	CHAMPION	LENGTH	BOX/CASE	APPROX. WT. LBS.	LIST
40080	80300-12	112RB-E	Close (1- 3/8")	25/400	0.15	
40081	80300-1215	113RB-E15	x 1-1/2"	25/400	0.16	
40082	80300-1220	113RB-E2	x 2"	25/300	0.21	
40083	80300-1225	113RB-E25	x 2-1/2"	25/300	0.27	
40084	80300-1230	113RB-E3	x 3"	25/200	0.32	
40085	80300-1235	113RB-E35	x 3-1/2"	25/200	0.37	
40086	80300-1240	113RB-E4	x 4"	25/150	0.43	
40087	80300-1245	113RB-E45	x 4-1/2"	25/150	0.48	
40088	80300-1250	113RB-E5	x 5"	25/100	0.53	
40089	80300-1255	113RB-E55	x 5-1/2"	25/100	0.59	
40090	80300-1260	113RB-E6	x 6"	25/100	0.64	
40091	80300-1270	113RB-E7	x 7"	25/75	0.75	
40092	80300-1280	113RB-E8	x 8"	25/75	0.85	
40093	80300-1290	113RB-E9	x 9"	25/75	0.96	
40094	80300-1292	113RB-E10	x 10"	25/50	1.06	
40095	80300-1294	113RB-E11	x 11"	25/50	1.17	
40096	80300-1296	113RB-E12	x 12"	25/50	1.28	
40097	80300-129918		x 18"	1/1	1.92	
40098	80300-129924		x 24"	1/1	2.56	

113RB



1" - 11 1/2

1" DIAMETER SCH 40 SEAMLESS

MIDLAND	AMC	LENGTH	BOX/CASE	APPROX. WT. LBS.	LIST
40100	80300-16	Close (1-1/2")	25/200	0.23	
40101	80300-1620	x 2"	25/200	0.30	
40102	80300-1625	x 2-1/2"	25/150	0.38	
40103	80300-1630	x 3"	25/150	0.45	
40104	80300-1635	x 3-1/2"	25/100	0.53	
40105	80300-1640	x 4"	25/100	0.60	
40106	80300-1645	x 4-1/2"	25/100	0.68	
40107	80300-1650	x 5"	25/75	0.75	
40108	80300-1655	x 5-1/2"	25/75	0.83	
40109	80300-1660	x 6"	25/50	0.94	
40110	80300-1670	x 7"	25/50	1.05	
40111	80300-1680	x 8"	25/50	1.20	
40112	80300-1690	x 9"	25/50	1.35	
40113	80300-1692	x 10"	25/50	1.50	
40114	80300-1694	x 11"	25/50	1.65	
40115	80300-1696	x 12"	20/40	1.80	
40118		x 18"			
40119		x 24"			

WARNING: This product can expose you to chemicals, including Nickel, which are known to the State of California to cause cancer. For more information, visit www.P65Warnings.ca.gov

SCH 40 SEAMLESS

NIPPLES AND FITTINGS



**LEAD
FREE**

1 1/4" - 11 1/2"

1-1/4" DIAMETER SCH 40 SEAMLESS

MIDLAND	AMC	LENGTH	BOX/CASE	APPROX. WT. LBS.	LIST
40120	80300-20	Close (1-5/8")	25/100	0.36	
40121	80300-2020	x 2"	25/100	0.44	
40122	80300-2025	x 2-1/2"	25/100	0.56	
40123	80300-2030	x 3"	25/100	0.67	
40124	80300-2035	x 3-1/2"	25/100	0.78	
40125	80300-2040	x 4"	25/50	0.89	
40126	80300-2045	x 4-1/2"	25/50	1.00	
40127	80300-2050	x 5"	25/50	1.11	
40128	80300-2055	x 5-1/2"	25/50	1.22	
40129	80300-2060	x 6"	25/50	1.33	
40130	80300-2070	x 7"	25/50	1.56	
40131	80300-2080	x 8"	25/50	1.78	
40132	80300-2090	x 9"	25/50	2.00	
40133	80300-2092	x 10"	25/50	2.22	
40134	80300-2094	x 11"	25/50	2.45	
40135	80300-2096	x 12"	25/50	2.67	
40136	80300-209918	x 18"	1/1	4.00	

113RB



**LEAD
FREE**

1-1/2" - 11 1/2"

1-1/2" DIAMETER SCH 40 SEAMLESS

MIDLAND	AMC	LENGTH	BOX/CASE	APPROX. WT. LBS.	LIST
40140	80300-24	Close (1-3/4")	25/100	0.46	
40141	80300-2420	x 2"	25/100	0.53	
40142	80300-2425	x 2-1/2"	25/50	0.66	
40143	80300-2430	x 3"	25/50	0.79	
40144	80300-2435	x 3-1/2"	25/50	0.93	
40145	80300-2440	x 4"	25/50	1.06	
40146	80300-2445	x 4-1/2"	25/50	1.19	
40147	80300-2450	x 5"	20/40	1.32	
40148	80300-2455	x 5-1/2"	20/40	1.46	
40149	80300-2460	x 6"	20/40	1.59	
40150	80300-2470	x 7"	20/40	1.85	
40151	80300-2480	x 8"	20/40	2.12	
40152	80300-2490	x 9"	20/40	2.38	
40153	80300-2492	x 10"	20/40	2.65	
40154	80300-2494	x 11"	1/40	2.91	
40155	80300-2496	x 12"	1/15	3.18	
40156	80300-249918	x 18"	1/1	4.77	

WARNING: This product can expose you to chemicals, including Nickel, which are known to the State of California to cause cancer. For more information, visit www.P65Warnings.ca.gov



SCH 40 SEAMLESS

NIPPLES AND FITTINGS



2" - 11 1/2

2" DIAMETER SCH 40 SEAMLESS

MIDLAND	AMC	LENGTH	BOX/CASE	APPROX. WT. LBS.	LIST
40160	80300-32	Close (2")	25/50	0.69	
40161	80300-3225	x 2-1/2"	25/50	0.86	
40162	80300-3230	x 3"	25/50	1.03	
40163	80300-3235	x 3-1/2"	25/50	1.20	
40164	80300-3240	x 4"	1/25	1.37	
40165	80300-3245	x 4-1/2"	1/25	1.54	
40166	80300-3250	x 5"	1/25	1.72	
40167	80300-3255	x 5-1/2"	1/25	1.89	
40168	80300-3260	x 6"	1/25	2.06	
40169	80300-3270	x 7"	1/20	2.40	
40170	80300-3280	x 8"	1/18	2.74	
40171	80300-3290	x 9"	1/18	3.09	
40172	80300-3292	x 10"	1/18	3.43	
40173	80300-3294	x 11"	1/18	3.77	
40174	80300-3296	x 12"	1/14	4.12	
40175	80300-329918	x 18"	1/1	6.18	
40176	80300-329924	x 24"	1/1	8.24	
40178	80300-329936	x 36"	1/1	12.36	
40179	80300-329948	x 48"	1/1	16.48	

113RB



2 1/2" - 8

2-1/2" DIAMETER SCH 40 SEAMLESS

MIDLAND	AMC	LENGTH	BOX/CASE	APPROX. WT. LBS.	LIST
40180	80300-40	Close (2-1/2")	1/36	1.26	
40181	80300-4030	x 3"	1/36	1.51	
40182	80300-4035	x 3-1/2"	1/30	1.76	
40183	80300-4040	x 4"	1/30	2.02	
40184	80300-4045	x 4-1/2"	1/30	2.27	
40185	80300-4050	x 5"	1/20	2.52	
40186	80300-4055	x 5-1/2"	1/20	2.77	
40187	80300-4060	x 6"	1/20	3.03	
40193		x 12"			

See our Valve section for 2-1/2, 3 and 4" Valves

WARNING: This product can expose you to chemicals, including Nickel, which are known to the State of California to cause cancer. For more information, visit www.P65Warnings.ca.gov

SCH 40 SEAMLESS

NIPPLES AND FITTINGS



LEAD FREE

3" DIAMETER SCH 40 SEAMLESS

MIDLAND	AMC	LENGTH	BOX/CASE	APPROX. WT. LBS.	LIST
40200	80300-48	Close (2-5/8")	1/24	1.89	
40201	80300-4830	x 3"	1/20	2.16	
40202	80300-4835	x 3-1/2"	1/18	2.52	
40203	80300-4840	x 4"	1/18	2.88	
40204	80300-4845	x 4-1/2"	1/18	3.24	
40205	80300-4850	x 5"	1/18	3.60	
40206	80300-4855	x 5-1/2"	1/18	3.96	
40207	80300-4860	x 6"	1/12	4.32	
40209	80300-4880	x 8"	1/1	5.76	
40213	80300-4896	x 12"	1/1		

113RB



LEAD FREE

4" DIAMETER SCH 40 SEAMLESS

MIDLAND	AMC	LENGTH	BOX/CASE	APPROX. WT. LBS.	LIST
40220	80300-64	Close (2-7/8)	1/20	2.40	
40221	80300-6430	x 3"	1/10	2.72	
40222	80300-6435	x 3-1/2"	1/10	3.18	
40223	80300-6440	x 4"	1/10	3.71	
40224	80300-6445	x 4-1/2"	1/5	4.24	
40225	80300-6450	x 5"	1/5	4.77	
40226	80300-6455	x 5-1/2"	1/5	5.30	
40234	80300-6460	x 6"	1/5	6.36	



LEAD FREE

6" DIAMETER SCH 40 SEAMLESS

MIDLAND	AMC	LENGTH	BOX/CASE	APPROX. WT. LBS.	LIST
40254		Close	1/1	4.94	
40256		x 4"	1/1	6.54	
40259		x 4-1/2"	1/1	7.12	
40260		x 5"	1/1	7.91	
40261		x 6"	1/1	9.49	

WARNING: This product can expose you to chemicals, including Nickel, which are known to the State of California to cause cancer. For more information, visit www.P65Warnings.ca.gov



CHROME PLATED

NIPPLES AND FITTINGS

113CP



3/8" DIAMETER CHROME PLATED

MIDLAND	AMC	LENGTH	BOX/CASE	APPROX. WT. LBS.	LIST
41040	81300-06	X Close	5/25	0.05	
41041	81300-0615	x 1-1/2"	5/25	0.08	
41042	81300-0620	x 2"	5/25	0.10	
41043	81300-0625	x 2-1/2"	5/25	0.13	
41044	81300-0630	x 3"	5/25	0.16	
41045	81300-0635	x 3-1/2"	5/25	0.18	
41046	81300-0640	x 4"	5/25	0.21	
41047	81300-0645	x 4-1/2"	5/25	0.23	
41048	81300-0650	x 5"	5/25	0.26	
41049	81300-0655	x 5-1/2"	5/25	0.29	
41050	81300-0660	x 6"	5/25	0.31	
41054	81300-0692	x 10"	1/1	0.52	
41056	81300-0696	x 12"	1/1	0.62	



1/2" DIAMETER CHROME PLATED

MIDLAND	AMC	LENGTH	BOX/CASE	APPROX. WT. LBS.	LIST
41060	81300-08	X Close	5/25	0.09	
41061	81300-0815	x 1-1/2"	5/25	0.12	
41062	81300-0820	x 2"	5/25	0.16	
41063	81300-0825	x 2-1/2"	5/25	0.20	
41064	81300-0830	x 3"	5/25	0.23	
41065	81300-0835	x 3-1/2"	5/25	0.27	
41066	81300-0840	x 4"	5/25	0.31	
41067	81300-0845	x 4-1/2"	5/25	0.35	
41068	81300-0850	x 5"	5/25	0.39	
41069	81300-0855	x 5-1/2"	5/25	0.43	
41070	81300-0860	x 6"	5/25	0.47	
41074	81300-0892	x 10"	1/1	0.78	
41075		x 11"	1/1	0.86	
41076	81300-0896	x 12"	1/1	0.94	
41077		x 18"	1/1	1.41	
41079		x 24"	1/1	1.88	
41244		x 36"	1/1	2.82	
41245		x 48"	1/1	3.76	

 **WARNING:** This product can expose you to chemicals, including Nickel, which are known to the State of California to cause cancer. For more information, visit www.P65Warnings.ca.gov

CHROME PLATED

NIPPLES AND FITTINGS



81300-12

3/4" DIAMETER CHROME PLATED

MIDLAND	AMC	LENGTH	BOX/CASE	APPROX. WT. LBS.	LIST
41080	81300-12	Close (1- 3/8")	25/400	0.15	
41081	81300-1215	x 1-1/2"	25/400	0.16	
41082	81300-1220	x 2"	25/300	0.21	
41083	81300-1225	x 2-1/2"	25/300	0.27	
41084	81300-1230	x 3"	25/200	0.32	
41085	81300-1235	x 3-1/2"	25/200	0.37	
41086	81300-1240	x 4"	25/150	0.43	
41087	81300-1245	x 4-1/2"	25/150	0.48	
41088	81300-1250	x 5"	25/100	0.53	
41089	81300-1255	x 5-1/2"	25/100	0.59	
41090	81300-1260	x 6"	25/100	0.64	



81300-16

1" DIAMETER CHROME PLATED

MIDLAND	AMC	LENGTH	BOX/CASE	APPROX. WT. LBS.	LIST
41100	81300-16	Close (1-1/2")	25/200	0.23	
41101	81300-1620	x 2"	25/200	0.30	
41102	81300-1625	x 2-1/2"	25/150	0.38	
41103	81300-1630	x 3"	25/150	0.45	
41104	81300-1635	x 3-1/2"	25/100	0.53	
41105	81300-1640	x 4"	25/100	0.60	
41106	81300-1645	x 4-1/2"	25/100	0.68	
41107	81300-1650	x 5"	25/75	0.75	
41108	81300-1655	x 5-1/2"	25/75	0.83	
41109	81300-1660	x 6"	25/50	0.94	

 **WARNING:** This product can expose you to chemicals, including Nickel, which are known to the State of California to cause cancer. For more information, visit www.P65Warnings.ca.gov

BRONZE FITTINGS

NIPPLES AND FITTINGS

BRONZE FITTINGS



UL842, UL258, UL125,FM

Class 125 (150) For steam, water, gas, oil and air service
Standard specifications

Materials - ASTM B62-93 (85,5,5,5) C83600

Dimensions - ANSI B 16.15

Threads - ANSI B2.1 or BA 21 and Fed. WW-P-460C, MSS-SP-106, ANSI/ASME B1.20.1

PRICING FILE AVAILABLE ONLINE

- UL/ FM Approved
- ISO 9001:2000
- Not Lead Free
- RoHS Compliant

Bronze threaded fittings are manufactured from smooth-cored castings, designed to provide full flow with minimum restriction. All threads are accurately machined and gauged to ensure a perfect fit with the pipe. All fittings are individually tested under water to ensure quality. Bronze provides a tighter seal and is easier to install than other metals. Can be used for water, plumbing, heating, pneumatic and marine applications, able to resist the harmful effects of corrosion when coming into contact with salt water or fresh water polluted with mineral acids or peaty soils.

LEAD FREE BRASS FITTINGS



- Approved to ANSI/NSF 61-4 California AB 1953
- Meets Federal State Drinking Water Act, Lead Free Requirement
- Brass fittings conform to AWWA C800
- Brass castings conform to ASTM B584, UNS Alloy C8933

- Brass fittings dimensions conform to ASME B16.15
- NPT threads on all fittings conform to ASME B1.20.1
- Brass unions conform to specification A-A-59617
- Manufacturing facilities are ISO 9001:2008

PRICING FILE AVAILABLE ONLINE

WARNING: This product can expose you to chemicals, including Nickel, which are known to the State of California to cause cancer. For more information, visit www.P65Warnings.ca.gov

BRONZE/ LEAD FREE BRONZE

NIPPLES AND FITTINGS

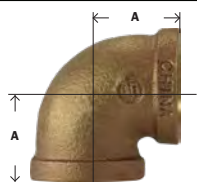

100RB

738100



90° ELBOWS

MIDLAND	AMC	LIST	BOX/CASE	SIZE	MIDLAND	AMC	LIST
44100	38100-02		50/600	1/8"	44100LF	738100-02	
44101	38100-04		35/420	1/4"	44101LF	738100-04	
44102	38100-06		90/360	3/8"	44102LF	738100-06	
44103	38100-08		50/200	1/2"	44103LF	738100-08	
44104	38100-12		35/105	3/4"	44104LF	738100-12	
44105	38100-16		20/60	1"	44105LF	738100-16	
44106	38100-20		20/40	1-1/4"	44106LF	738100-20	
44107	38100-24		15/30	1-1/2"	44107LF	738100-24	
44108	38100-32		8/16	2"	44108LF	738100-32	
44109	38100-40		1/12	2-1/2"	44109LF	738100-40	
44110	38100-48		1/4	3"	44110LF	738100-48	
44112	38100-64		1/2	4"	44112LF	738100-64	

• Other sizes available online

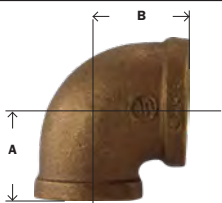

100RRB

738105



90° REDUCING ELBOWS

MIDLAND	AMC	LIST	BOX/CASE	SIZE	MIDLAND	AMC	LIST
44120	38105-0402			1/4 x 1/8	44120LF	738105-0402	
				3/8 x 1/8	44121LF	738105-0602	
44122	38105-0604			3/8 x 1/4	44122LF	738105-0604	
44123	38105-0804		60/240	1/2 x 1/4	44123LF	738105-0804	
44124	38105-0806		60/240	1/2 x 3/8	44124LF	738105-0806	
44125	38105-1204		40/160	3/4 x 1/4	44125LF	738105-1204	
				3/4 x 3/8	44126LF	738105-1206	
44127	38105-1208			3/4 x 1/2	44127LF	738105-1208	
				1 x 1/4	44128LF	738105-1604	
				1 x 3/8	44129LF		
				1 x 1/2	44130LF	738105-1608	
44131	38105-1612		50/100	1 x 3/4	44131LF	738105-1612	
				1 1/4 x 1/2	44132LF		
				1 1/4 x 3/4	44133LF	738105-2012	
44134	38105-2016		25/50	1 1/4 x 1	44134LF	738105-2016	
				1 1/2 x 1/2	44135LF	738105-2408	
				1 1/2 x 3/4	44136LF	738105-2412	
44137	38105-2416		10/40	1 1/2 x 1	44137LF	738105-2416	
				1 1/2 x 1 1/4	44138LF	738105-2420	
44140	38105-3216			2 x 1	44140LF	738105-3216	
				2 x 1 1/4	44141LF	738105-3220	
				2 x 1 1/2	44142LF	738105-3224	
				2 1/2 x 2	44146LF	738105-4032	
				3 x 2	44150LF	738105-4832	

WARNING: This product can expose you to chemicals, including Nickel, which are known to the State of California to cause cancer. For more information, visit www.P65Warnings.ca.gov

BRONZE/ LEAD FREE BRONZE

NIPPLES AND FITTINGS

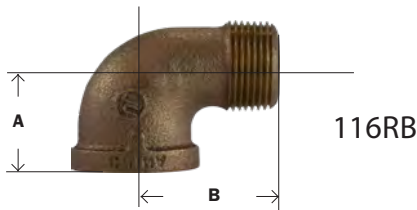

738116



90° STREET ELLS

MIDLAND	AMC	LIST	BOX/CASE	SIZE	MIDLAND	AMC	LIST
44160	38116-02		60/720	1/8"	44160LF	738116-02	
44161	38116-04		35/420	1/4"	44161LF	738116-04	
44162	38116-06		60/240	3/8"	44162LF	738116-06	
44163	38116-08		60/180	1/2"	44163LF	738116-08	
44164	38116-12		35/105	3/4"	44164LF	738116-12	
44165	38116-16		45/90	1"	44165LF	738116-16	
44166	38116-20		25/50	1-1/4"	44166LF	738116-20	
44167	38116-24		9/27	1-1/2"	44167LF	738116-24	
44168	38116-32		8/16	2"	44168LF	738116-32	
44169	38116-40		5/10	2-1/2"	44169LF	738116-40	
44170	38116-48		1/8	3"	44170LF	738116-48	



738107



45° ELBOWS

MIDLAND	AMC	LIST	BOX/CASE	SIZE	MIDLAND	AMC	LIST
44180	38107-02		50/600	1/8"	44180LF	738107-02	
44181	38107-04		30/360	1/4"	44181LF	738107-04	
44182	38107-06		75/300	3/8"	44182LF	738107-06	
44183	38107-08		50/200	1/2"	44183LF	738107-08	
44184	38107-12		40/120	3/4"	44184LF	738107-12	
44185	38107-16		20/60	1"	44185LF	738107-16	
44186	38107-20		20/40	1-1/4"	44186LF	738107-20	
44187	38107-24		10/30	1-1/2"	44187LF	738107-24	
44188	38107-32		12/24	2"	44188LF	738107-32	
44189	38107-40		1/12	2-1/2"	44189LF	738107-40	
44190	38107-48		1/10	3"	44190LF	738107-48	
				4"	44191LF	738107-64	

WARNING: This product can expose you to chemicals, including Nickel, which are known to the State of California to cause cancer. For more information, visit www.P65Warnings.ca.gov

BRONZE/ LEAD FREE BRONZE

NIPPLES AND FITTINGS

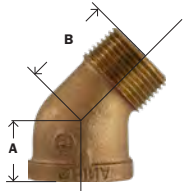

124RB

738124



45° STREET ELBOWS

MIDLAND	AMC	LIST	BOX/CASE	SIZE	MIDLAND	AMC	LIST
44200	38124-02		70/840	1/8"			
44201	38124-04		100/400	1/4"	44201LF	738124-04	
44202	38124-06		100/400	3/8"	44202LF	738124-06	
44203	38124-08		75/225	1/2"	44203LF	738124-08	
44204	38124-12		40/120	3/4"	44204LF	738124-12	
44205	38124-16		25/75	1"	44205LF	738124-16	
44206	38124-20		10/40	1-1/4"	44206LF	738124-20	
44207	38124-24		10/30	1-1/2"	44207LF	738124-24	
44208	38124-32		12/24	2"	44208LF	738124-32	



102RB

738102



CROSSES

MIDLAND	AMC	LIST	BOX/CASE	SIZE	MIDLAND	AMC	LIST
44391	38102-04		60/240	1/4"	44391LF	738102-04	
44392	38102-06		50/150	3/8"	44392LF	738102-06	
44393	38102-08		30/90	1/2"	44393LF	738102-08	
44394	38102-12		20/60	3/4"	44394LF	738102-12	
44395	38102-16		15/30	1"	44395LF	738102-16	
44396	38102-20		10/20	1-1/4"	44396LF	738102-20	
44397	38102-24		8/16	1-1/2"	44397LF	738102-24	
44398			5/10	2"	44398LF	738102-32	

WARNING: This product can expose you to chemicals, including Nickel, which are known to the State of California to cause cancer. For more information, visit www.P65Warnings.ca.gov

BRONZE/ LEAD FREE BRONZE

NIPPLES AND FITTINGS

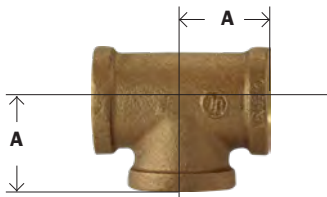

101RB

**LEAD
FREE**



TEES

MIDLAND	AMC	LIST	BOX/CASE	SIZE	MIDLAND	AMC	LIST
44250	38101-02		120/480	1/8"	44250LF	738101-02	
44251	38101-04		75/300	1/4"	44251LF	738101-04	
44252	38101-06		45/180	3/8"	44252LF	738101-06	
44253	38101-08		40/120	1/2"	44253LF	738101-08	
44254	38101-12		35/70	3/4"	44254LF	738101-12	
44255	38101-16		20/40	1"	44255LF	738101-16	
44256	38101-20		14/28	1-1/4"	44256LF	738101-20	
44257	38101-24		12/24	1-1/2"	44257LF	738101-24	
44258	38101-32		8/16	2"	44258LF	738101-32	
44259	38101-40		1/6	2-1/2"	44259LF	738101-40	
44260	38101-48		1/6	3"	44260LF	738101-48	
				4"	44261LF	738101-64	



USE OUR APP WITH YOUR FREE BIN LABELS TO MANAGE YOUR CUSTOMERS INVENTORY MORE EFFICIENTLY

WARNING: This product can expose you to chemicals, including Nickel, which are known to the State of California to cause cancer. For more information, visit www.P65Warnings.ca.gov

BRONZE/ LEAD FREE BRONZE

NIPPLES AND FITTINGS

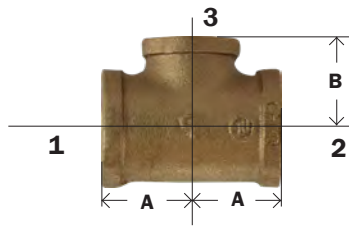

101RRB

738106



REDUCING TEES REDUCING ON THE BRANCH

MIDLAND	AMC	LIST	BOX/CASE	SIZE 1 X 2 X 3	MIDLAND	AMC	LIST
				1/4 x 1/4 x 1/8	44270LF	738106-040402	
				3/8 x 3/8 x 1/4	44273LF	738106-060604	
44276	38106-080804		40/160	1/2 x 1/2 x 1/4	44276LF	738106-080804	
				1/2 x 1/2 x 3/8	44279LF	738106-080806	
44280	38106-080812		40/160	1/2 x 1/2 x 3/4	44280LF	738106-080812	
44287	38106-120808			3/4 x 1/2 x 1/2	44287LF	738106-120808	
				3/4 x 1/2 x 3/4	44288LF	738106-120812	
44282	38106-121204		25/100	3/4 x 3/4 x 1/4	44282LF	738106-121204	
44283	38106-121206		25/100	3/4 x 3/4 x 3/8	44283LF	738106-121206	
44286	38106-121208		20/80	3/4 x 3/4 x 1/2	44286LF	738106-121208	
				1 x 1/2 x 1/2	44292LF	738106-160808	
				1 x 1/2 x 3/4	44293LF	738106-160812	
44296	38106-161212			1 x 3/4 x 3/4	44296LF		
				1 x 1 x 1/4	44268LF	738106-161604	
				1 x 1 x 3/8	44290LF	738106-161606	
44291			15/60	1 x 1 x 1/2	44291LF	738106-161608	
44298	38106-161612		12/48	1 x 1 x 3/4	44298LF	738106-161612	
				1 1/4 x 1/2 x 1 1/4	44314LF		
44301	38106-202008		20/40	1 1/4 x 1 1/4 x 1/2	44301LF	738106-202008	
44303	38106-202012		20/40	1 1/4 x 1 1/4 x 3/4	44303LF	738106-202012	
44306	38106-202016		20/40	1 1/4 x 1 1/4 x 1	44306LF	738106-202016	
				1 1/2 x 1 1/2 x 1/2	44315LF		
				1 1/2 x 1 1/2 x 3/4	44316LF	738106-241212	
				1 1/2 x 1 1/2 x 1	44318LF		
				1 1/2 x 1 1/2 x 1 1/4	44322LF		
				2 x 2 x 1/2	44327LF	738106-323208	
				2 x 2 x 3/4	44328LF		
				2 x 2 x 1	44330LF	738106-323216	
				2 x 2 x 1 1/4	44334LF		
				2 x 2 x 1 1/2	44336LF	738106-323224	
				2 1/2 x 2 1/2 x 2	44344LF		
				3 x 3 x 2	44351LF	738106-484832	



VIEW PRICING AND AVAILABLE STOCK ONLINE

WARNING: This product can expose you to chemicals, including Nickel, which are known to the State of California to cause cancer. For more information, visit www.P65Warnings.ca.gov

BRONZE/ LEAD FREE BRONZE

NIPPLES AND FITTINGS



103RB

738103



COUPLINGS

MIDLAND	AMC	LIST	BOX/CASE	SIZE	MIDLAND	AMC	LIST
44410	38103-02		70/840	1/8"	44410LF	738103-02	
44411	38103-04		40/480	1/4"	44411LF	738103-04	
44412	38103-06		40/480	3/8"	44412LF	738103-06	
44413	38103-08		60/240	1/2"	44413LF	738103-08	
44414	38103-12		50/150	3/4"	44414LF	738103-12	
44415	38103-16		25/100	1"	44415LF	738103-16	
44416	38103-20		16/64	1-1/4"	44416LF	738103-20	
44417	38103-24		18/36	1-1/2"	44417LF	738103-24	
44418	38103-32		12/24	2"	44418LF	738103-32	
44419	38103-40		1	2-1/2"	44419LF	738103-40	
44420	38103-48		1	3"	44420LF	738103-48	
				4"	44421LF	738103-64	

WARNING: This product can expose you to chemicals, including Nickel, which are known to the State of California to cause cancer. For more information, visit www.P65Warnings.ca.gov

BRONZE/ LEAD FREE BRONZE

NIPPLES AND FITTINGS



119RB

738119



REDUCING COUPLINGS

MIDLAND	AMC	LIST	BOX/CASE	SIZE	MIDLAND	AMC	LIST
44430	38119-0402		70/840	1/4" x 1/8"	44430LF	738119-0402	
44431	38119-0602		35/420	3/8" x 1/8"	44431LF	738119-0602	
44432	38119-0604		30/360	3/8" x 1/4"	44432LF	738119-0604	
44433	38119-0802		75/300	1/2" x 1/8"	44433LF		
44434	38119-0804		75/300	1/2" x 1/4"	44434LF	738119-0804	
44435	38119-0806		60/240	1/2" x 3/8"	44435LF	738119-0806	
44436	38119-1204		45/180	3/4" x 1/4"	44436LF	738119-1204	
44437	38119-1206		45/180	3/4" x 3/8"	44437LF	738119-1206	
44438	38119-1208		60/180	3/4" x 1/2"	44438LF	738119-1208	
44440	38119-1606		30/120	1" x 3/8"	44440LF		
44441	38119-1608		30/120	1" x 1/2"	44441LF	738119-1608	
44442	38119-1612		25/100	1" x 3/4"	44442LF	738119-1612	
44444	38119-2008		25/75	1-1/4" x 1/2"	44444LF	738119-2008	
44445	38119-2012		25/75	1-1/4" x 3/4"	44445LF	738119-2012	
44446	38119-2016		15/60	1-1/4" x 1"	44446LF	738119-2016	
44447	38119-2408		20/60	1-1/2" x 1/2"	44447LF	738119-2408	
44448	38119-2412		15/60	1-1/2" x 3/4"	44448LF	738119-2412	
44449	38119-2416		25/50	1-1/2" x 1"	44449LF	738119-2416	
44450	38119-2420		12/48	1-1/2" x 1-1/4"	44450LF	738119-2420	
44458	38119-3208		12/36	2" x 1/2"	44458LF		
44451	38119-3212		12/36	2" x 3/4"	44451LF	738119-3212	
44452	38119-3216		12/36	2" x 1"	44452LF	738119-3216	
44453	38119-3220		9/27	2" x 1-1/4"	44453LF	738119-3220	
44454	38119-3224		9/27	2" x 1-1/2"	44454LF	738119-3224	
44461	38119-4024		1	2-1/2" x 1-1/2"	44461LF		
44462	38119-4032		1	2-1/2" x 2"	44462LF	738119-4032	
44456	38119-4832		1	3" x 2"	44456LF		
44463	38119-4840		1	3" x 2-1/2"	44463LF		

WARNING: This product can expose you to chemicals, including Nickel, which are known to the State of California to cause cancer.
 For more information, visit www.P65Warnings.ca.gov

NIPPLES & FITTINGS

BRONZE/ LEAD FREE BRONZE

NIPPLES AND FITTINGS



108RB

738108



CAPS

MIDLAND	AMC	LIST	BOX/CASE	SIZE	MIDLAND	AMC	LIST
44470	38108-02		80/160	1/8"	44470LF	738108-02	
44471	38108-04		80/960	1/4"	44471LF	738108-04	
44472	38108-06		60/720	3/8"	44472LF	738108-06	
44473	38108-08		75/300	1/2"	44473LF	738108-08	
44474	38108-12		40/160	3/4"	44474LF	738108-12	
44475	38108-16		25/100	1"	44475LF	738108-16	
44476	38108-20		20/80	1-1/4"	44476LF	738108-20	
44477	38108-24		18/54	1-1/2"	44477LF	738108-24	
44478	38108-32		12/36	2"	44478LF	738108-32	
44479	38108-40			2-1/2"	44479LF	738108-40	
44480	38108-48		1	3"	44480LF	738108-48	
				4"	44481LF	738108-64	



104RB

738104



UNIONS

MIDLAND	AMC	LIST	BOX/CASE	SIZE	MIDLAND	AMC	LIST
44600	38104-02		40/160	1/8"	44600LF	738104-02	
44601	38104-04		40/160	1/4"	44601LF	738104-04	
44602	38104-06		40/160	3/8"	44602LF	738104-06	
44603	38104-08		50/100	1/2"	44603LF	738104-08	
44604	38104-12		35/70	3/4"	44604LF	738104-12	
44605	38104-16		20/40	1"	44605LF	738104-16	
44606	38104-20		15/30	1-1/4"	44606LF	738104-20	
44607	38104-24		10/20	1-1/2"	44607LF	738104-24	
44608	38104-32		6/12	2"	44608LF	738104-32	
44609	38104-40		4/8	2-1/2"	44609LF	738104-40	
44610	38104-48		4/8	3"	44610LF	738104-48	
				4"	44611LF	738104-64	

WARNING: This product can expose you to chemicals, including Nickel, which are known to the State of California to cause cancer. For more information, visit www.P65Warnings.ca.gov

BRONZE/ LEAD FREE BRONZE

NIPPLES AND FITTINGS



738110



HEX BUSHINGS

MIDLAND	AMC	LIST	BOX/CASE	SIZE	MIDLAND	AMC	LIST
44500	38110-0402		120/1440	1/4" x 1/8"	44500LF	738110-0402	
44501	38110-0602		75/900	3/8" x 1/8"	44501LF	738110-0602	
44502	38110-0604		75/900	3/8" x 1/4"	44502LF	738110-0604	
44503	38110-0802		150/600	1/2" x 1/8"	44503LF	738110-0802	
44504	38110-0804		150/600	1/2" x 1/4"	44504LF	738110-0804	
44505	38110-0806		150/600	1/2" x 3/8"	44505LF	738110-0806	
44506	38110-1202		75/300	3/4" x 1/8"	44506LF	738110-1202	
44507	38110-1204		75/300	3/4" x 1/4"	44507LF	738110-1204	
44508	38110-1206		75/300	3/4" x 3/8"	44508LF	738110-1206	
44509	38110-1208		75/300	3/4" x 1/2"	44509LF	738110-1208	
44557	38110-1602		50/200	1" x 1/8"			
44510*	38110-1604		50/200	1" x 1/4"	44510LF*	738110-1604	
44511*	38110-1606		50/200	1" x 3/8"	44511LF	738110-1606	
44512	38110-1608		50/200	1" x 1/2"	44512LF	738110-1608	
44513	38110-1612		50/200	1" x 3/4"	44513LF	738110-1612	
44514	38110-2004		30/120	1-1/4" x 1/4"	44514LF	738110-2004	
44515	38110-2006		30/120	1-1/4" x 3/8"	44515LF	738110-2006	
44516*	38110-2008		30/120	1-1/4" x 1/2"	44516LF*	738110-2008	
44517	38110-2012		30/120	1-1/4" x 3/4"	44517LF	738110-2012	
44518	38110-2016		30/120	1-1/4" x 1"	44518LF	738110-2016	
44519*	38110-2404		25/75	1-1/2" x 1/4"	44519LF	738110-2404	
44520*	38110-2406		25/75	1-1/2" x 3/8"	44520LF	738110-2406	
44521*	38110-2408		25/75	1-1/2" x 1/2"	44521LF*	738110-2408	
44522*	38110-2412		25/75	1-1/2" x 3/4"	44522LF*	738110-2412	
44523	38110-2416		25/75	1-1/2" x 1"	44523LF	738110-2416	
44524	38110-2420		25/75	1-1/2" x 1-1/4"	44524LF	738110-2420	
44527*	38110-3208		20/60	2" x 1/2"	44527LF	738110-3208	
44528*	38110-3212		20/60	2" x 3/4"	44528LF	738110-3212	
44529*	38110-3216		20/60	2" x 1"	44529LF*	738110-3216	
44530	38110-3220		20/60	2" x 1-1/4"	44530LF	738110-3220	
44531	38110-3224		20/60	2" x 1-1/2"	44531LF	738110-3224	
44532	38110-4016		15/30	2-1/2" x 1"	44532LF	738110-4016	
			15/30	2-1/2" x 1-1/4"	44533LF	738110-4020	
44534	38110-4024		15/30	2-1/2" x 1-1/2"	44534LF	738110-4024	
44535	38110-4032		15/30	2-1/2" x 2"	44535LF	738110-4032	
44537	38110-4824		12/24	3" x 1-1/2"	44537LF	738110-4824	
44538	38110-4832		12/24	3" x 2"	44538LF	738110-4832	
44539	38110-4840		12/24	3" x 2-1/2"	44539LF	738110-4840	
44541	38110-6432		5/10	4" x 2"	44541LF	738110-6432	
			5/10	4" x 2-1/2"	44542LF	738110-6440	
44543	38110-6448		12/24	4" x 3"	44543LF	738110-6448	

* INSIDE HEX



WARNING: This product can expose you to chemicals, including Nickel, which are known to the State of California to cause cancer. For more information, visit www.P65Warnings.ca.gov

NIPPLES & FITTINGS

BRONZE/ LEAD FREE BRONZE

NIPPLES AND FITTINGS

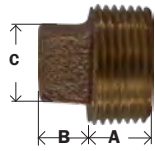

109RB

738109



CORED SQUARE HEAD PLUGS

MIDLAND	AMC	LIST	BOX/CASE	SIZE	MIDLAND	AMC	LIST
44650*	38109-02		300/3600	1/8"	44650LF	738109-02	
44651*	38109-04		150/1800	1/4"	44651LF	738109-04	
44652*	38109-06		100/1200	3/8"	44652LF	738109-06	
44653	38109-08		50/600	1/2"	44653LF	738109-08	
44654	38109-12		30/360	3/4"	44654LF	738109-12	
44655	38109-16		20/240	1"	44655LF	738109-16	
44656	38109-20		40/120	1-1/4"	44656LF	738109-20	
44657	38109-24		30/90	1-1/2"	44657LF	738109-24	
44658	38109-32		20/60	2"	44658LF	738109-32	
44659	38109-40		16/32	2-1/2"	44659LF	738109-40	
44660	38109-48		16/32	3"	44660LF	738109-48	
44662	38109-64		6/12	4"	44662LF	738109-64	

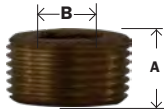

109ALRB

SQUARE DRIVE BRONZE COUNTERSUNK PLUGS

738115



MIDLAND	AMC	LIST	SIZE	BOX/CASE	MIDLAND	AMC	LIST
			1/8"		44630LF		
			1/4"		44631LF		
			3/8"		44632LF		
44633	38115-08		1/2"	120/1440	44633LF		
44634	38115-12		3/4"	70/840	44634LF		
44635	38115-16		1"	20/240	44635LF		
44636	38115-20		1-1/4"	40/120	44636LF		
44637	38115-24		1-1/2"	30/90	44637LF		
44638	38115-32		2"	20/60	44638LF		
44639	38115-40		2-1/2"	1/1	44639LF		
44640	38115-48		3"	1/1	44640LF		
44641	83115-64		4"	1/1	44641LF		



• Straight Thread

111RB

HEX LOCKNUTS

738111

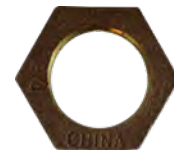

MIDLAND	AMC	LIST	BOX/CASE	SIZE	MIDLAND	AMC	LIST
44700	38111-02		180/720	1/8"	44700LF	780111-02	
44701	38111-04		90/540	1/4"	44701LF	738111-04	
44702	38111-06		90/540	3/8"	44702LF	738111-06	
44703	38111-08		90/360	1/2"	44703LF	738111-08	
44704	38111-12		90/360	3/4"	44704LF	738111-12	
44705	38111-16		50/150	1"	44705LF	738111-16	
44706	38111-20		45/180	1-1/4"	44706LF	738111-20	
44707	38111-24		45/135	1-1/2"	44707LF	738111-24	
44708	38111-32		25/75	2"	44708LF	738111-32	

WARNING: This product can expose you to chemicals, including Nickel, which are known to the State of California to cause cancer. For more information, visit www.P65Warnings.ca.gov

BRONZE/ LEAD FREE BRONZE

NIPPLES AND FITTINGS

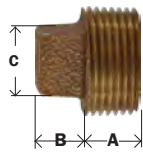

109SRB

738114



SOLID SQUARE HEAD PLUGS

MIDLAND	AMC	LIST	SIZE	BOX/CASE	MIDLAND	AMC	LIST
44670	38114-02		1/8"	400/4800	44670LF	738114-02	
44671	38114-04		1/4"	150/1800	44671LF	738114-04	
44672	38114-06		3/8"	120/1440	44672LF	738114-06	
44673	38114-08		1/2"	50/600	44673LF	738114-08	
44674	38114-12		3/4"	35/420	44674LF	738114-12	
44675	38114-16		1"	20/240	44675LF	738114-16	
44676	38114-20		1-1/4"	30/120	44676LF	738114-20	
44677	38114-24		1-1/2"	30/90	44677LF	738114-24	
44678	38114-32		2"	10/60	44678LF	738114-32	
			2-1/2"		44679LF	780114-40	
			3"		44680LF	780114-48	

HEX NIPPLES

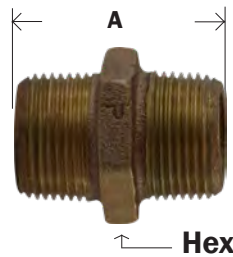

MIDLAND	AMC	LIST	SIZE	BOX/CASE
44720			1/8"	400/4800
44721			1/4"	150/1800
44722			3/8"	120/1440
44723			1/2"	240/480
44724			3/4"	80/320
44725			1"	50/150
44726			1-1/4"	50/100
44727			1-1/2"	35/70
44728			2"	20/40
44729			2-1/2"	1
44730M			3"	4/8

REDUCING HEX NIPPLES

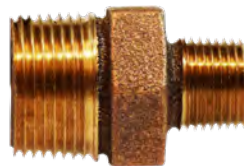

MIDLAND	AMC	LIST	SIZE	BOX/CASE
44740			1/4" x 1/8"	1/1
44742			1/2" x 3/8"	1/1
44753			1-1/2" x 1-1/4"	1/1

WARNING: This product can expose you to chemicals, including Nickel, which are known to the State of California to cause cancer. For more information, visit www.P65Warnings.ca.gov

BRONZE/ LEAD FREE BRONZE

NIPPLES AND FITTINGS

FLANGE THREADED COMPANION LEAD-FREE



MIDLAND	AMC	LIST	SIZE	STD. PACK.	WT. PER 100
44790LF	738150-08		1/2" x 3-1/2"	1	95
44791LF	780150-12		3/4" x 3-7/8"	1	124
44792LF	738150-16		1" x 4-1/4"	1	168
44793LF	738150-20		1-1/4" x 4-5/8"	1	224
44794LF	738150-24		1-1/2" x 5"	1	251
44795LF	738150-32		2" x 6"	1	454
44796LF	738150-40		2-1/2" x 7"	1	673
44797LF	738150-48		3" x 7-1/2"	1	864
44798LF	738150-64		4" x 9"	1	1227
44799LF	780150-80		5" x 10"	1	1495
44800LF			6" x 11"	1	1801

FLANGE SWEAT COMPANION LEAD FREE



MIDLAND	AMC	LIST	SIZE	STD. PACK.	WT. PER 100
44827LF			1-1/2" x 5"	1	176
44828LF			2" x 6"	1	291
44829LF			2-1/2" x 7"	1	405
44830LF			3" x 7-1/2"	1	520
44831LF			4" x 9"	1	798

FLANGE FLOOR LEAD FREE



MIDLAND	AMC	LIST	SIZE	STD. PACK.	WT. PER 100
44780LF	738151-08		1/2"	1	35
44781LF	738151-12		3/4"	1	44
44782LF	738151-16		1"	1	59
44783LF	780151-20		1-1/4"	1	87
44784LF	738151-24		1-1/2"	1	105
44785LF	738151-32		2"	1	150

WARNING: This product can expose you to chemicals, including Nickel, which are known to the State of California to cause cancer. For more information, visit www.P65Warnings.ca.gov



CHROME PLATED BRONZE FITTINGS

NIPPLES AND FITTINGS

90° ELBOW



LEAD FREE

781100

MIDLAND	AMC	SIZE	LIST
45102LF	781100-06	3/8"	
45103LF	781100-08	1/2"	
45104LF	781100-12	3/4"	
45105LF	781100-16	1"	

COUPLING



LEAD FREE

781103

MIDLAND	AMC	SIZE	LIST
45412LF	781103-06	3/8"	
45413LF	781103-08	1/2"	

90° ELBOW



81100

MIDLAND	AMC	SIZE	LIST
45100	81100-02	1/8"	
45101		1/4"	
45102	81100-06	3/8"	
45103	81100-08	1/2"	
45104	81100-12	3/4"	
45105	81100-16	1"	
45124	81105-0806	1/2" x 3/8"	
45127	81105-1208	3/4" x 1/2"	

90° STREET ELLS



81116

MIDLAND	AMC	SIZE	LIST
45160	81100-02	1/8"	
45161		1/4"	
45162	781116-06	3/8"	
45163	81116-08	1/2"	
45164	781116-12	3/4"	
45165	81116-15	1"	

90° STREET ELBOW



LEAD FREE

781116

MIDLAND	AMC	SIZE	LIST
45163LF	781116-08	1/2"	

TEE



LEAD FREE

781101

MIDLAND	AMC	SIZE	LIST
45252LF		3/8"	
45253LF		1/2"	

45° ELBOW



81124

MIDLAND	AMC	SIZE	LIST
45200	81124-02	1/8"	
45201	81124-04	1/4"	
45202	81124-06	3/8"	
45203	81124-08	1/2"	
45204	81124-12	3/4"	

CROSSES



81102

MIDLAND	AMC	SIZE	LIST
45393	81102-08	1/2"	
45394	81102-12	3/4"	

WARNING: This product can expose you to chemicals, including Nickel, which are known to the State of California to cause cancer. For more information, visit www.P65Warnings.ca.gov

CHROME PLATED BRONZE FITTINGS

NIPPLES AND FITTINGS

45° ELBOWS



81107

MIDLAND	AMC	SIZE	LIST
45180	81107-02	1/8"	
45181	780124-04	1/4"	
45182	81107-06	3/8"	
45183	781107-08	1/2"	
45184	81107-12	3/4"	
45185	81107-16	1"	

TEES



81101

MIDLAND	AMC	SIZE	LIST
45250	81101-02	1/8"	
45251	81101-04	1/4"	
45252	81101-06	3/8"	
45253	81101-08	1/2"	
45254	81101-12	3/4"	
45255	81101-16	1"	

COUPLINGS



81103

MIDLAND	AMC	SIZE	LIST
45410	81103-02	1/8"	
45411	81103-04	1/4"	
45412	81103-06	3/8"	
45413	81103-08	1/2"	
45414	81103-12	3/4"	
45415	81103-16	1"	
45432		3/8" x 1/4"	
45435	81119-0806	1/2" x 3/8"	
45438	81119-1208	3/4" x 1/2"	
45439	81119-1612	1" x 3/4"	

CAPS



81108

MIDLAND	AMC	SIZE	LIST
45470	81108-02	1/8"	
45471	81108-04	1/4"	
45472	81108-06	3/8"	
45473	81108-08	1/2"	
45474	81108-12	3/4"	
45475	81108-16	1"	

UNIONS



81104

MIDLAND	AMC	SIZE	LIST
45600	81104-02	1/8"	
45601	81104-04	1/4"	
45602		3/8"	
45603	781104-08	1/2"	
45604	81104-12	3/4"	
45605	81104-16	1"	
45606	81104-20	1-1/4"	

HEX BUSHINGS



81110

MIDLAND	AMC	SIZE	LIST
45502	781110-0604	3/8" x 1/4"	
45504	81110-0804	1/2" x 1/4"	
45505	781110-0806	1/2" x 3/8"	
45509	781110-1208	3/4" x 1/2"	
45513	81110-1612	1" x 3/4"	

PLUGS



MIDLAND	AMC	SIZE	LIST
45652	81109-06	3/8"	
45653	81109-08	1/2"	
45654	781109-12	3/4"	
45655	81109-16	1"	
45657		1-1/2"	

WARNING: This product can expose you to chemicals, including Nickel, which are known to the State of California to cause cancer. For more information, visit www.P65Warnings.ca.gov

CLEANOUT PLUGS/ DROP EAR ELBOWS

NIPPLES AND FITTINGS



• Southern Code

CAST BRASS SQUARE HEAD CLEANOUT PLUG

PART #	SIZE	BOX/CASE	
970300	1-1/2"	100/200	----
970301	2"	100/200	----
970302	2-1/2"	50/200	----
970303	3"	20/160	----
970304	3-1/2"	20/120	----
970305	4"	10/80	----
970330	5"	10/60	----
970331	6"	10/40	----
970332	8"	5/20	----
970333	10"	1/1	----



• Southern Code

CAST BRASS COUNTERSUNK HEAD CLEANOUT PLUG

PART #	SIZE	BOX/CASE	
970306	1-1/2"	100/200	----
970307	2"	100/200	----
970308	2-1/2"	100/200	----
970309	3"	50/200	----
970310	3-1/2"	20/160	----
970311	4"	20/120	----
970312	5"	10/60	----
970313	6"	10/40	----
970314	8"	5/20	----



CAST BRASS COUNTERSUNK CLEANOUT W 1/4-20 TAP

PART #	SIZE	BOX/CASE	
970700	1-1/2"	1/1	----
970701	2"	1/1	----
970702	2-1/2"	1/1	----
970703	3"	1/1	----
970704	3-1/2"	1/1	----
970705	4"	1/1	----
970706	5"	1/1	----
970707	6"	1/1	----

DROP EAR ELBOWS

• Lead Free Brass

• Lead Free Bronze



PART #	SWT X FIP	
44840LF	1/2 x 1/2 Bronze	----
44841LF	1/2 x 1/2 Brass	----
44842LF	3/4 x 1/2 Brass	----
44843LF	3/4 x 3/4 Brass	----



• Lead Free Brass

PART #	SWT X SWT	
44844LF	1/2 x 1/2	----



• Lead Free
Bronze

PART #	PEX X FIP	
44845LF	1/2 x 1/2	----

WARNING: This product can expose you to chemicals, including Nickel, which are known to the State of California to cause cancer. For more information, visit www.P65Warnings.ca.gov

BRONZE/ STEEL INSERT FITTINGS

NIPPLES AND FITTINGS

BRONZE INSERT FITTINGS

150 PSI Genuine red brass - for plastic pipe

- Not Lead Free

HEX MALE ADAPTERS



(Barb x Male Pipe)

PART #	BARB X MALE	
973925	3/4" x 3/4"	----
973927	1" x 1"	----
973930	1" x 1-1/4"	----
973929	1-1/4" x 1"	----
973928	1-1/4" x 1-1/4"	----
973948	1-1/2" x 1-1/2"	----
973949	2" x 2"	----

BRONZE TEES ALL BARB



PART #	SIZE	
973965	3/4"	----
973966	1"	----
973967	1-1/4"	----

ELBOWS



(Barb x Male Pipe)

PART #	SIZE	
973980	3/4" x 3/4"	----
973981	1" x 3/4"	----
973982	1" x 1"	----

ELBOWS



(Barb x Barb)

PART #	HOSE SIZE	
973975	3/4"	----
973976	1"	----
973977	1-1/4" x 1"	----
973978	1-1/4"	----
973979	1-1/2"	----

STEEL INSERT FITTINGS FOR PLASTIC PIPE

MALE ADAPTER

- Galvanized



(Barb x Male Pipe)

PART #	SIZE	BOX/CASE	
973906	1/2"	25/100	----
973907	3/4"	25/10	----
973908	1"	16/48	----
973909	1-1/4"	12/36	----
973910	1-1/2"	6/36	----
973911	2"	5/25	----
973912	2-1/2"	1/3	----
973913	3"	1/3	----
973914	4"	1/3	----



(Insert x NPT)

PART #	SIZE	
974264	3/4 x 1/2	----
974265	1 x 3/4	----
974266	1-1/4 x 1	----
974267	1-1/2 x 1-1/4	----

COUPLINGS



PART #	SIZE	BOX/CASE	
973900	1/2	30/120	----
973901	3/4	20/100	----
973902	1	20/100	----
973903	1-1/4	16/64	----
973904	1-1/2	12/48	----
973905	2	5/25	----

WARNING: This product can expose you to chemicals, including Nickel, which are known to the State of California to cause cancer. For more information, visit www.P65Warnings.ca.gov

SS AND LEAD FREE BRONZE INSERT

NIPPLES AND FITTINGS

STAINLESS STEEL #304



#304 INSERT X MALE PIPE

- For coiled plastic pipe to submersible pump

PART #	SIZE	
973947SS	1/2 x 1/2	----
973925SS	3/4 x 3/4	----
973926SS	1 x 3/4	----
973927SS	1 x 1	----
973930SS	1 x 1-1/4	----
973928SS	1-1/4 x 1-1/4	----
973948SS	1-1/2 x 1-1/2	----
973949SS	2 x 2	----



#304 INSERT X MIP ELBOW

- Hydrant elbow

PART #	SIZE	
973980SS	3/4 x 3/4	----
973982SS	1 x 1	----
973985SS	1-1/4 x 1-1/4	----

LEAD FREE BRONZE INSERT FITTINGS

- NSF Approved
- ANSI 61-8



INSERT X INSERT

PART #	SIZE	
973960LF	1/2	----
973961LF	3/4	----
973962LF	1	----
973963LF	1-1/4	----

- NSF Approved
- ANSI 61-8



INSERT TEE

PART #	SIZE	
973965LF	3/4	----
973966LF	1	----
973967LF	1-1/4	----

- NSF Approved
- ANSI 61-8



INSERT X MALE BRANCH TEE

PART #	SIZE	
973969LF	3/4	----
973970LF	1 x 3/4	----
973971LF	1	----

- NSF Approved
- ANSI 61-8



INSERT X INSERT ELBOW

PART #	SIZE	
973975LF	3/4	----
973976LF	1	----

WELL COUPLINGS



304 SS DROP WELL COUPLINGS STANDARD

PART #	SIZE	
62415DC	1	----
62416DC	1-1/4	----
62417DC	1-1/2	----
62418DC	2	----



HEAVY WALLED SS 304 DROP WELL COUPLINGS

PART #	SIZE	
62415HDDC	1	----
62416HDDC	1-1/4	----
62417HDDC	1-1/2	----
62418HDDC	2	----



#304 STAINLESS STEEL MERCHANT COUPLINGS

PART #	SIZE	
61775	1	----
61776	1-1/4	----
61777	1-1/2	----
61778	2	----

WARNING: This product can expose you to chemicals, including Nickel, which are known to the State of California to cause cancer. For more information, visit www.P65Warnings.ca.gov

SCH 40 STAINLESS STEEL NIPPLES

NIPPLES AND FITTINGS

STAINLESS STEEL NIPPLES**SCHEDULE 40 WELDED**

Stainless steel pipe nipples are manufactured from stainless steel pipe that conforms to specification ASTM A312/SA312.

All stainless steel nipples conform to specification ASTM A733. Threads conform to the requirements of ANSI B1.20.1.

SEE MIDLANDINDUSTRIES.COM FOR SCHEDULE 80 NIPPLES

304

The basic alloy. Type 304 (18-8) is an austenitic steel possessing a minimum of 18% chromium and 8% nickel, combined with a maximum of 0.08% carbon. It is a nonmagnetic steel which cannot be hardened by heat treatment, but instead, must be cold worked to obtain higher tensile strengths.

Because of its ability to withstand the corrosive action of various acids found in fruits, meats, milk, and vegetables,

Type 304 is especially suited for all types of dairy equipment piping and valves, the brewing industry, the citrus and fruit juice industry, and in food processing applications. Also used for the dye tanks, pipelines buckets, dippers, etc. that come in contact with the lormic, acetic, and other organic acids used in the dyeing industry.

In the marine environment, because of its slightly higher strength and wear resistance than type 316 it is also used for nuts, bolts, screws, and other fasteners. It is also used for springs, cogs, and other components where both wear and corrosion resistance is needed.

SCHEDULE 80 SEAMLESS

- SEAMLESS FOR UNRESTRICTED FLOW
- USE WITH AIR, WATER, OIL, NATURAL GAS, STEAM
- FITTINGS: USE THREADED CLASS 3000 HIGH-PRESSURE STAINLESS STEEL.

- ASTM A733 • ASTM A312 • ANSI/ ASME B1.20.1
- PSI 3000

316

For severe environments. Of course, there are many industrial processes that require a higher level of resistance to corrosion than Type 304 can offer. For these applications, Type 316 is the answer.

In type 316, the nickel content is increased slightly. What distinguishes Type 316 from Type 304 is the addition of molybdenum up to a maximum of 3%.

Molybdenum increases the corrosion resistance of this chromium-nickel alloy to withstand attack by many industrial chemicals and solvents, and, in particular, inhibits pitting caused by chlorides. As such, molybdenum is one of the single most useful alloying additives in the fight against corrosion.

Type 316 can withstand corrosive attack by sodium and calcium brines, hypochlorite solutions, phosphoric acid; and the sulfite liquors and sulfurous acids used in the paper pulp industry. This alloy, therefore, is specified for industrial equipment that handles the corrosive process chemicals used to produce inks, rayons, photographic chemicals, paper, textiles, bleaches, and rubber. Type 316 is also used extensively for surgical implants within the hostile environment of the body.

Type 316 is the main stainless used in the marine environment, with the exception of fasteners and other items where strength and wear resistance are

WARNING: This product can expose you to chemicals, including Nickel, which are known to the State of California to cause cancer. For more information, visit www.P65Warnings.ca.gov



SCH 40 STAINLESS STEEL NIPPLES

NIPPLES AND FITTINGS

#304

1/8" - 27

#316



**1/8" DIAMETER
SCH 40 WELDED**



PART # 304 S.S.	LENGTH	BOX	APPROX. WT. LBS.	PART # 316 S.S.
48001	X Close (3/4")	25	0.01	49001
48002	x 1-1/2"	25	0.03	49002
48003	x 2"	25	0.04	49003
48004	x 2-1/2"	25	0.05	49004
48005	x 3"	25	0.06	49005
48006	x 3-1/2"	25	0.07	49006
48007	x 4"	25	0.07	49007
48008	x 4-1/2"	25	0.09	49008
48009	x 5"	25	0.10	49009
48010	x 5-1/2"	25	0.11	49010
48011	x 6"	25	0.12	49011
	x 8"			49013
48015	x 10"	1	0.19	
	x 12"	1	0.24	49017

1/4" - 18



**1/4" DIAMETER
SCH 40 WELDED**



PART # 304 S.S.	LENGTH	BOX	APPROX. WT. LBS.	PART # 316 S.S.
48020	X Close (7/8")	25	0.02	49020
48021	x 1-1/2"	25	0.04	49021
48022	x 2"	25	0.06	49022
48023	x 2-1/2"	25	0.07	49023
48024	x 3"	25	0.09	49024
48025	x 3-1/2"	25	0.11	49025
48026	x 4"	25	0.13	49026
48027	x 4-1/2"	25	0.14	49027
48028	x 5"	25	0.16	49028
48029	x 5-1/2"	25	0.18	49029
48030	x 6"	25	0.19	49030
48031	x 7"	1	0.22	49031
48032	x 8"	1	0.25	49032
	x 9"	1	0.31	49033
48034	x 10"	1	0.35	49034
	x 11"	1	0.40	49035
48036	x 12"	1	0.44	49036
	x 14"	1	0.46	49037
	x 16"	1	0.47	49038



GO ONLINE TO VIEW OPEN ORDERS, ORDER HISTORY, AND TRACKING INFORMATION ON ALL SHIPMENTS

WARNING: This product can expose you to chemicals, including Nickel, which are known to the State of California to cause cancer. For more information, visit www.P65Warnings.ca.gov

NIPPLES & FITTINGS

SCH 40 STAINLESS STEEL NIPPLES

NIPPLES AND FITTINGS

#304

3/8"-18

#316



**3/8" DIAMETER
SCH 40 WELDED**



PART # 304 S.S.	LENGTH	BOX	APPROX. WT. LBS.	PART # 316 S.S.
48040	X Close (1")	25	0.03	49040
48041	x 1-1/2"	25	0.06	49041
48042	x 2"	25	0.07	49042
48043	x 2-1/2"	25	0.10	49043
48044	x 3"	25	0.12	49044
48045	x 3-1/2"	25	0.15	49045
48046	x 4"	25	0.17	49046
48047	x 4-1/2"	25	0.19	49047
48048	x 5"	25	0.22	49048
48049	x 5-1/2"	25	0.23	49049
48050	x 6"	25	0.26	49050
48052	x 8"	1	0.34	49052
48053	x 9"	1		
48054	x 10"	1	0.43	49054
48056	x 12"	1		



1/2" - 14

**1/2" DIAMETER
SCH 40 WELDED**



PART # 304 S.S.	LENGTH	BOX	APPROX. WT. LBS.	PART # 316 S.S.
48060	X Close 1-1/8"	25	0.05	49060
48061	x 1-1/2"	25	0.07	49061
48062	x 2"	25	0.10	49062
48063	x 2-1/2"	25	0.14	49063
48064	x 3"	25	0.18	49064
48065	x 3-1/2"	25	0.20	49065
48066	x 4"	25	0.25	49066
48067	x 4-1/2"	25	0.28	49067
48068	x 5"	25	0.31	49068
48069	x 5-1/2"	25	0.34	49069
48070	x 6"	25	0.39	49070
48071	x 7"	1	0.41	
48072	x 8"	1	0.52	49072
48073	x 9"	1	0.54	
48074	10"	1	0.58	49074
48075	x 11"	1	0.64	
48076	x 12"	1	0.69	49076



USE OUR TEXT LINE [855-609-3729](tel:855-609-3729) TO COMMUNICATE WITH MIDLAND MORE CONVENIENTLY

WARNING: This product can expose you to chemicals, including Nickel, which are known to the State of California to cause cancer. For more information, visit www.P65Warnings.ca.gov



SCH 40 STAINLESS STEEL NIPPLES

NIPPLES AND FITTINGS

#304



3/4" - 14

3/4" DIAMETER
SCH 40 WELDED

#316



PART # 304 S.S.	LENGTH	BOX	APPROX. WT. LBS.	PART # 316 S.S.
48080	X Close (1-3/8")	25	0.08	49080
48081	x 1-1/2"	25	0.13	49081
48082	x 2"	25	0.14	49082
48083	x 2-1/2"	25	0.17	49083
48084	x 3"	25	0.22	49084
48085	x 3-1/2"	25	0.27	49085
48086	x 4"	25	0.32	49086
48087	x 4-1/2"	25	0.38	49087
48088	x 5"	25	0.40	49088
48089	x 5-1/2"	25	0.42	49089
48090	x 6"	25	0.48	49090
48091	x 7"	1	0.45	49091
48092	x 8"	1	0.67	49092
48094	x 10"	1	0.94	49094
48096	x 12"	1	1.03	49096



1" - 11 1/2

1" DIAMETER
SCH 40 WELDED



PART # 304 S.S.	LENGTH	BOX	APPROX. WT. LBS.	PART # 316 S.S.
48100	X Close (1-1/2")	25	0.13	49100
48101	x 2"	25	0.20	49101
48102	x 2-1/2"	25	0.25	49102
48103	x 3"	25	0.33	49103
48104	x 3-1/2"	25	0.40	49104
48105	x 4"	25	0.47	49105
48106	x 4-1/2"	25	0.53	49106
48107	x 5"	25	0.55	49107
48108	x 5-1/2"	25	0.60	49108
48109	x 6"	25	0.71	49109
48110	x 7"	1	0.57	49110
48111	x 8"	1	1.02	49111
48113	x 10"	1	1.16	49113
48115	x 12"	1	1.31	49115



HELP US HELP YOU! GO ONLINE TO UPDATE YOUR CUSTOMER PROFILE SO THAT WE CAN UPDATE ALL THE APPROPRIATE DEPARTMENTS AND PERSONNEL AT YOUR COMPANY ON NEW CATALOGS, PRICING UPDATES, NEW MARKETING TOOLS, AND OTHER IMPORTANT INFORMATION. THANK YOU!

WARNING: This product can expose you to chemicals, including Nickel, which are known to the State of California to cause cancer. For more information, visit www.P65Warnings.ca.gov

NIPPLES & FITTINGS

SCH 40 STAINLESS STEEL NIPPLES

NIPPLES AND FITTINGS



1 1/4" - 11 1/2"



1-1/4" DIAMETER SCH 40 WELDED

PART # 304 S.S.	LENGTH	BOX	APPROX. WT. LBS.	PART # 316 S.S.
48120	X Close (1-5/8")	10	0.17	49120
48121	x 2"	10	0.23	49121
48122	x 2-1/2"	10	0.35	49122
48123	x 3"	10	0.46	49123
48124	x 3-1/2"	10	0.52	49124
48125	x 4"	10	0.65	49125
48126	x 4-1/2"	10	0.53	49126
48127	x 5"	10	0.60	49127
48128	x 5-1/2"	10	0.61	49128
48129	x 6"	10	0.71	49129
48131	x 8"	1	1.34	
48135	x 12"	1	1.54	



1-1/2" - 11 1/2"



1-1/2" DIAMETER SCH 40 WELDED

PART # 304 S.S.	LENGTH	BOX	APPROX. WT. LBS.	PART # 316 S.S.
48140	X Close x 1-3/4"	10	0.25	49140
48141	x 2"	10	0.32	49141
48142	x 2-1/2"	10	0.41	49142
48143	x 3"	10	0.52	49143
48144	x 3-1/2"	10	0.62	49144
48145	x 4"	10	0.73	49145
48146	x 4-1/2"	10	0.86	49146
48147	x 5"	10	0.95	49147
48148	x 5-1/2"	10	1.01	49148
48149	x 6"	10	1.19	49149
48151	x 8"	1	1.63	49151
48152	x 9"	1	1.88	
48153	x 10"	1	2.28	49153
48155	x 12"	1	2.43	

• See our website for threaded one end (TOE) nipples

See our website for Sch. 80 # 304 and #316 Stainless Steel Seamless Nipples.



SEE WEBSITE TO DOWNLOAD YOUR MOST UPDATED PRICING

WARNING: This product can expose you to chemicals, including Nickel, which are known to the State of California to cause cancer.
 For more information, visit www.P65Warnings.ca.gov

SCH 40 STAINLESS STEEL NIPPLES

NIPPLES AND FITTINGS



2" DIAMETER SCH 40 WELDED



PART # 304 S.S.	LENGTH	BOX	APPROX. WT. LBS.	PART # 316 S.S.
48160	X Close (2")	10	0.37	49160
48161	x 2-1/2"	10	0.54	49161
48162	x 3"	10	0.65	49162
48163	x 3-1/2"	10	0.88	49163
48164	x 4"	10	1.02	49164
48165	x 4-1/2"	10	1.16	49165
48166	x 5"	10	1.29	49166
48167	x 5-1/2"	10	1.46	49167
48168	x 6"	10	1.57	49168
48169	x 7"	1	1.92	49169
48170	x 8"	1	2.01	49170
48171	x 9"	1	2.55	
48172	x 10"	1	2.69	
48174	x 12"	1	2.89	

2-1/2" DIAMETER SCH 40 WELDED

PART # 304 S.S.	LENGTH	BOX	APPROX. WT. LBS.
48180	X Close (2-1/2")	10	0.64
48181	x 3"		
48187	x 6"	1	2.37
48193	x 12"	1	4.85



3" DIAMETER SCH 40 WELDED

PART # 304 S.S.	LENGTH	BOX	APPROX. WT. LBS.	PART # 316 S.S.
48200	X Close (2-5/8")	10	0.95	49200
48201	x 3"	10	1.32	49201
48203	x 4"	10	1.66	49203
48205	x 5"	5	1.72	49205
48207	x 6"	5	1.88	49207
48209	x 8"	1	1.91	49209
48213	x 12"	1	2.12	49213



4" DIAMETER SCH 40 WELDED

PART # 304 S.S.	LIST PRICE	LENGTH	BOX	APPROX. WT. LBS.	PART # 316 S.S.	LIST PRICE
48220	----	X Close (2-7/8")	8	1.15	49220	----
		x 4"	1	2.98	49223	----
48227	----	x 6"	1	4.10	49234	----
		x 8"	1	5.95	49236	----
		x 12"	1	9.25	49240	----

WARNING: This product can expose you to chemicals, including Nickel, which are known to the State of California to cause cancer.
 For more information, visit www.P65Warnings.ca.gov



304 AND 316 150# SS FITTINGS

NIPPLES AND FITTINGS

STAINLESS STEEL FITTINGS



150# 304 & 316 Stainless Steel Fittings

Our high quality standard pattern 150lb rated stainless steel threaded fittings are manufactured to the highest standards. All stainless steel fittings are monitored by our quality control personnel for strict compliance with applicable standards and specifications.

These stainless steel pipe fittings are excellent for uses that involve chemicals or liquids that may be corrosive. Along with fighting corrosion, a stainless steel pipe fitting will prevent contamination making it useful to many professionals.

- Use with air, water, oil, natural gas, steam
- NPT and FNPT threads conform to ASME B1.20.1
- Maximum Pressure: 300 psi @ 72 F; 150 psi @ 366 F for steam
- Maximum Steam Pressure: 150 psi
- Material Conforms to ASTM A-351. Class 150 Pressure Ratings
- Manufacturing facility is ISO 9001:2008
- 304 Stainless Steel is economically priced, chromium-nickel material that offers very good corrosion resistance. 316 Stainless Steel has higher nickel content and contains molybdenum for even better corrosion resistance.

WARNING: This product can expose you to chemicals, including Nickel, which are known to the State of California to cause cancer. For more information, visit www.P65Warnings.ca.gov

304 AND 316 150# SS FITTINGS

NIPPLES AND FITTINGS

90° ELBOW 304 & 316 150#



PART # 304 S.S.		SIZE	BOX	APPROX. WT. LBS.	PART # 316 S.S.	
62100	----	1/8"	25	0.06	63100	----
62101	----	1/4"	25	0.06	63101	----
62102	----	3/8"	25	0.11	63102	----
62103	----	1/2"	25	0.13	63103	----
62104	----	3/4"	25	0.20	63104	----
62105	----	1"	10	0.33	63105	----
62106	----	1-1/4"	10	0.55	63106	----
62107	----	1-1/2"	5	0.77	63107	----
62108	----	2"	5	1.10	63108	----
62109	----	2-1/2"	1	2.09	63109	----
62110	----	3"	1	2.84	63110	----
62112	----	4"	1	5.00	63112	----

90° STREET ELBOW 304 & 316 150#



PART # 304 S.S.		SIZE	BOX	APPROX. WT. LBS.	PART # 316 S.S.	
62160	----	1/8"	25	0.04	63160	----
62161	----	1/4"	25	0.07	63161	----
62162	----	3/8"	25	0.09	63162	----
62163	----	1/2"	25	0.15	63163	----
62164	----	3/4"	25	0.24	63164	----
62165	----	1"	10	0.31	63165	----
62166	----	1-1/4"	10	0.51	63166	----
62167	----	1-1/2"	5	0.84	63167	----
62168	----	2"	5	1.26	63168	----
62169	----	3"	1	4.16	63170	----
		4"	1	7.61	63171	----

45° ELBOW 304 & 316 150#



PART # 304 S.S.	LIST PRICE	SIZE	BOX	APPROX. WT. LBS.	PART # 316 S.S.	
62180	----	1/8"	25	0.04	63180	----
62181	----	1/4"	25	0.07	63181	----
62182	----	3/8"	25	0.09	63182	----
62183	----	1/2"	25	0.13	63183	----
62184	----	3/4"	25	0.20	63184	----
62185	----	1"	10	0.33	63185	----
62186	----	1-1/4"	10	0.49	63186	----
62187	----	1-1/2"	5	0.66	63187	----
62188	----	2"	5	1.14	63188	----
62189	----	2-1/2"	1	2.82		
62190	----	3"	1	2.91	63190	----
62191	----	4"	1	5.05	63192	----

SEE OUR WEBSITE FOR STAINLESS STEEL FITTING DIMENSIONS

WARNING: This product can expose you to chemicals, including Nickel, which are known to the State of California to cause cancer.
 For more information, visit www.P65Warnings.ca.gov

NIPPLES & FITTINGS

304 AND 316 150# SS FITTINGS

NIPPLES AND FITTINGS

TEE 304 & 316 150#



PART # 304 S.S.		SIZE	BOX	APPROX. WT. LBS.	PART # 316 S.S.	
62250	----	1/8"	25	0.07	63250	----
62251	----	1/4"	25	0.07	63251	----
62252	----	3/8"	25	0.11	63252	----
62253	----	1/2"	25	0.20	63253	----
62254	----	3/4"	25	0.29	63254	----
62255	----	1"	10	0.42	63255	----
62256	----	1-1/4"	5	0.66	63256	----
62257	----	1-1/2"	5	0.99	63257	----
62258	----	2"	3	1.43	63258	----
62259	----	2-1/2"	1	1.43		
62260	----	3"	1	3.66	63260	----
		4"	1	7.19	63261	----

CROSS 304 & 316 150#



PART # 304 S.S.		SIZE	BOX	APPROX. WT. LBS.	PART # 316 S.S.	
		1/8"	25	0.06	63390	----
62391	----	1/4"	25	0.09	63391	----
62392	----	3/8"	25	0.13	63392	----
62393	----	1/2"	25	0.29	63393	----
62394	----	3/4"	10	0.44	63394	----
62395	----	1"	10	0.74	63395	----
62396	----	1-1/4"	5	1.25	63396	----
62397	----	1-1/2"	5	1.53	63397	----
62398	----	2"	1	2.28	63398	----
		3"	1	5.46	63400	----
		4"	1	9.41	63401	----

HEX NIPPLE 304 & 316 150#



PART # 304 S.S.	LIST PRICE	SIZE	BOX	APPROX. WT. LBS.	PART # 316 S.S.	LIST PRICE
62720	----	1/8"	1	0.02	63720	----
62721	----	1/4"	1	0.04	63721	----
62722	----	3/8"	1	0.07	63722	----
62723	----	1/2"	1	0.11	63723	----
62724	----	3/4"	1	0.18	63724	----
62725	----	1"	1	0.22	63725	----
62726	----	1-1/4"	1	0.37	63726	----
62727	----	1-1/2"	1	0.46	63727	----
62728	----	2"	1	0.61	63728	----

REDUCING HEX NIPPLE 304 & 316 150#



PART # 304 S.S.	LIST PRICE	SIZE	BOX	APPROX. WT. LBS.	PART # 316 S.S.	
62740	----	1/4" x 1/8"	1	0.04	63740	----
62741	----	3/8" x 1/8"	1	0.07	63741	----
62742	----	3/8" x 1/4"	1	0.07	63742	----
62744	----	1/2" x 1/4"	1	0.09	63744	----
62745	----	1/2" x 3/8"	1	0.11	63745	----
62747	----	3/4" x 1/4"	1	0.15	63747	----
62748	----	3/4" x 3/8"	1	0.15	63748	----
62749	----	3/4" x 1/2"	1	0.15	63749	----

WARNING: This product can expose you to chemicals, including Nickel, which are known to the State of California to cause cancer. For more information, visit www.P65Warnings.ca.gov

304 AND 316 150# SS FITTINGS

NIPPLES AND FITTINGS

COUPLING 304 & 316 150#



PART # 304 S.S.		SIZE*	BOX	APPROX. WT. LBS.	PART # 316 S.S.	
62410	----	1/8"	25	0.03	63410	----
62411	----	1/4"	25	0.06	63411	----
62412	----	3/8"	25	0.07	63412	----
62413	----	1/2"	25	0.13	63413	----
62414	----	3/4"	25	0.18	63414	----
62415	----	1"	25	0.24	63415	----
62416	----	1-1/4"	10	0.44	63416	----
62417	----	1-1/2"	10	0.51	63417	----
62418	----	2"	5	0.79	63418	----
62419	----	2-1/2"	1	1.28	63419	----
62420	----	3"	1	1.87	63420	----
62421	----	4"	1	2.80	63421	----

REDUCING COUPLING 304 & 316 150#



PART # 304 S.S.		SIZE	BOX	APPROX. WT. LBS.	PART # 316 S.S.	
62430	----	1/4" x 1/8"	25	0.04	63430	----
62431	----	3/8" x 1/8"	25	0.04	63431	----
62432	----	3/8" x 1/4"	25	0.04	63432	----
62433	----	1/2" x 1/8"	25	0.09	63433	----
62434	----	1/2" x 1/4"	25	0.09	63434	----
62435	----	1/2" x 3/8"	25	0.09	63435	----
62455	----	3/4" x 1/8"	25	0.13	63455	----
62436	----	3/4" x 1/4"	25	0.11	63436	----
62437	----	3/4" x 3/8"	25	0.13	63437	----
62438	----	3/4" x 1/2"	25	0.15	63438	----
		1" x 1/4"	25	0.25	63459	----
62440	----	1" x 3/8"	25	0.22	63440	----
62441	----	1" x 1/2"	25	0.24	63441	----
62442	----	1" x 3/4"	25	0.24	63442	----
62445	----	1-1/4" x 3/4"	10	0.33	63445	----
62446	----	1-1/4" x 1"	10	0.35	63446	----
62447	----	1-1/2" x 1/2"	10	0.40	63447	----
62448	----	1-1/2" x 3/4"	10	0.42	63448	----
62449	----	1-1/2" x 1"	10	0.44	63449	----
62450	----	1-1/2" x 1-1/4"	10	0.46	63450	----
62459		2" x 1/2"				
62451	----	2" x 3/4"				
62452	----	2" x 1"	5	0.57	63452	----
62453	----	2" x 1-1/4"	5	0.62	63453	----
62454	----	2" x 1-1/2"	5	0.62	63454	----
62462		2-1/2" x 2"				
62428	----	3" x 1"	1	1.82		
62456	----	3" x 2"	1	2.25		
62457		4" x 3"				

OD MACHINED COUPLING 304 & 316 150#

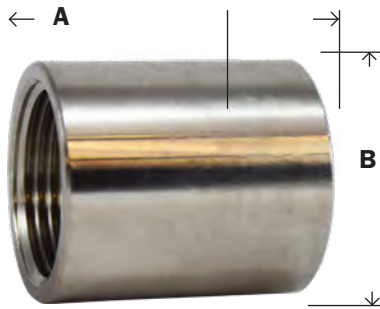

PART # 304 S.S.	LIST PRICE	SIZE	A	B	BOX	APPROX. WT. LBS.	PART # 316 S.S.	
62410B	----	1/8"	0.76	0.56	25	0.04	63410B	----
62411B	----	1/4"	0.94	0.71	25	0.04	63411B	----
62412B	----	3/8"	0.98	0.84	25	0.07	63412B	----
62413B	----	1/2"	1.33	1.01	25	0.09	63413B	----
62414B	----	3/4"	1.41	1.27	25	0.16	63414B	----
62415B	----	1"	1.69	1.54	10	0.21	63415B	----
62416B	----	1-1/4"	1.93	1.90	10	0.31	63416B	----
62417B	----	1-1/2"	1.93	2.16	5	0.41	63417B	----
62418B	----	2"	1.96	2.66	5	0.68	63418B	----
62420B	----	3"	3.23	3.76	1			

WARNING: This product can expose you to chemicals, including Nickel, which are known to the State of California to cause cancer.
 For more information, visit www.P65Warnings.ca.gov

304 AND 316 150# SS FITTINGS

NIPPLES AND FITTINGS

HALF COUPLING 304 & 316 150#

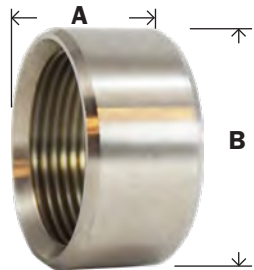

PART # 304 S.S.	LIST	SIZE	A	B	BOX	APPROX. WT. LBS.	PART # 316 S.S.
62770		1/8"					
62771	----	1/4"	0.39	0.70	25	0.02	63771
62772	----	3/8"	0.45	0.82	25	0.02	63772
62773	----	1/2"	0.57	1.02	25	0.09	63773
62774	----	3/4"	0.67	1.22	25	0.11	63774
62775	----	1"	0.79	1.47	25	0.13	63775
62776	----	1-1/4"	0.86	1.88	10	0.24	63776
62777	----	1-1/2"	0.94	2.10	10	0.26	63777
62778	----	2"	1.06	2.60	5	0.44	63778
62779		3"					

UNION 304 & 316 150#

• Stainless Steel Seat



PART # 304 S.S.	LIST PRICE	SIZE	BOX	APPROX. WT. LBS.	PART # 316 S.S.	LIST PRICE
62600	----	1/8"	25	0.09	63600	----
62601	----	1/4"	25	0.13	63601	----
62602	----	3/8"	25	0.22	63602	----
62603	----	1/2"	25	0.26	63603	----
62604	----	3/4"	25	0.46	63604	----
62605	----	1"	10	0.60	63605	----
62606	----	1-1/4"	5	0.90	63606	----
62607	----	1-1/2"	5	1.10	63607	----
62608	----	2"	1	1.81	63608	----
62609		2-1/2"				
62610	----	3"	1	3.40	63610	----

CAP - CAST 304 & 316 150#



PART # 304 S.S.		SIZE	BOX	APPROX. WT. LBS.	PART # 316 S.S.
62470	----	1/8"	25	0.02	63470
62471	----	1/4"	25	0.02	63471
62472	----	3/8"	25	0.04	63472
62473	----	1/2"	25	0.07	63473
62474	----	3/4"	25	0.11	63474
62475	----	1"	10	0.18	63475
62476	----	1-1/4"	10	0.29	63476
62477	----	1-1/2"	10	0.40	63477
62478	----	2"	10	0.60	63478
62480	----	3"	1	1.28	63480
62481	----	4"	1	1.54	

HEX CAP - BARSTOCK 304 & 316 150#

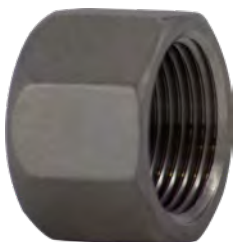

PART # 304 S.S.		SIZE	BOX	APPROX. WT. LBS.	PART # 316 S.S.
62075	----	1/8"	25	0.04	63075
62076	----	1/4"	25	0.09	63076
62077	----	3/8"	25	0.11	63077
62078	----	1/2"	25	0.13	63078
62079	----	3/4"	25	0.22	63079
62080	----	1"	10	0.22	63080
62081	----	1-1/4"	10	0.29	63081
62082	----	1-1/2"	5	0.40	63082
62083	----	2"	5	0.49	63083

WARNING: This product can expose you to chemicals, including Nickel, which are known to the State of California to cause cancer. For more information, visit www.P65Warnings.ca.gov

304 AND 316 150# SS FITTINGS

NIPPLES AND FITTINGS

HEX BUSHING 304 & 316 150#



PART # 304 S.S.		SIZE M X F	BOX	APPROX. WT. LBS.	PART # 316 S.S.	
62500	----	1/4" x 1/8"	25	0.04	63500	----
62501	----	3/8" x 1/8"	25	0.04	63501	----
62502	----	3/8" x 1/4"	25	0.04	63502	----
62503	----	1/2" x 1/8"	25	0.09		
62504	----	1/2" x 1/4"	25	0.09	63504	----
62505	----	1/2" x 3/8"	25	0.11	63505	----
62506	----	3/4" x 1/8"	25	0.13	63506	----
62507	----	3/4" x 1/4"	25	0.15	63507	----
62508	----	3/4" x 3/8"	25	0.15	63508	----
62509	----	3/4" x 1/2"	25	0.15	63509	----
62557	----	1" x 1/8"	25	0.27		
62510	----	1" x 1/4"	25	0.22	63510	----
62511	----	1" x 3/8"	25	0.24	63511	----
62512	----	1" x 1/2"	25	0.24	63512	----
62513	----	1" x 3/4"	25	0.24	63513	----
62515	----	1-1/4" x 3/8"	25	0.37		
62516	----	1-1/4" x 1/2"	25	0.37	63516	----
62517	----	1-1/4" x 3/4"	25	0.37	63517	----
62518	----	1-1/4" x 1"	25	0.37	63518	----
62521	----	1-1/2" x 1/2"	25	0.44	63521	----
62522	----	1-1/2" x 3/4"	25	0.46	63522	----
62532	----	1-1/2" x 1"	25	0.49	63523	----
62524	----	1-1/2" x 1-1/4"	25	0.46	63524	----
62559	----	2" x 1/4"	10	0.95	63526	
62527	----	2" x 1/2"	10	0.66	63527	----
62528	----	2" x 3/4"	10	0.66	63528	----
62529	----	2" x 1"	10	0.66	63529	----
62530	----	2" x 1-1/4"	10	0.68	63530	----
62531	----	2" x 1-1/2"	10	0.68	63531	----
62547		2-1/2" 3/4"				
62536	----	2-1/2" x 1"	5	1.70		
62534	----	2-1/2" x 1-1/2"	5	1.23	63534	----
62535	----	2-1/2" x 2"	5	1.21	63535	----
		3" x 1"	5	2.20	63550	----
62537	----	3" x 1-1/2"	5	1.97	63537	----
62538	----	3" x 2"	5	1.72	63538	----
62539	----	3" x 2-1/2"	5	1.81	63539	
		4" x 1-1/2"	5	3.92	63540	----
		4" x 2"	1	3.72	63541	----
62543	----	4" x 3"	1	2.43	63543	----

• STAINLESS STEEL BULKHEAD FITTINGS IN BULKHEAD SECTION

STAINLESS STEEL:

- BARBED FOR PLASTIC PIPE
- WELL COUPLINGS
- MERCHANT COUPLINGS
- SEE END OF BRONZE FITTING SECTION



GO ONLINE TO VIEW OPEN ORDERS, ORDER HISTORY, AND TRACKING INFORMATION ON ALL SHIPMENTS

WARNING: This product can expose you to chemicals, including Nickel, which are known to the State of California to cause cancer. For more information, visit www.P65Warnings.ca.gov

304 AND 316 150# SS FITTINGS

NIPPLES AND FITTINGS

HEX LOCKNUT

304 & 316 150#

• Straight Thread



PART # 304 S.S.		SIZE	BOX	APPROX. WT. LBS.	PART # 316 S.S.	
62700	----	1/8"	25	0.02		
62701	----	1/4"	25	0.05	63701	----
62702	----	3/8"	25	0.06	63702	----
62703	----	1/2"	25	0.07	63703	----
62704	----	3/4"	25	0.11	63704	----
62705	----	1"	25	0.15	63705	----
62706	----	1-1/4"	25	0.22	63706	----
62707	----	1-1/2"	25	0.29	63707	----
62708	----	2"	10	0.35	63708	----

CORED SQUARE HEAD PLUG

304 & 316 150#



PART # 304 S.S.		SIZE	BOX	APPROX. WT. LBS.	PART # 316 S.S.	
62670	----	1/8"	25	0.02	63670	----
62671	----	1/4"	25	0.03	63671	----
62672	----	3/8"	25	0.04	63672	----
62653	----	1/2"	25	0.06	63653	----
62654	----	3/4"	25	0.13	63654	----
62655	----	1"	25	0.20	63655	----
62656	----	1-1/4"	25	0.32	63656	----
62657	----	1-1/2"	10	0.41	63657	----
62658	----	2"	10	0.65	63658	----
62659	----	2-1/2"	1	1.04		
62660	----	3"	1	0.88		

CORED HEX HEAD PLUG

304 & 316 150#



PART # 304 S.S.		SIZE	BOX	APPROX. WT. LBS.	PART # 316 S.S.	
62630	----	1/8"	25	0.02	63630	----
62631	----	1/4"	25	0.02	63631	----
62632	----	3/8"	25	0.04	63632	----
62633	----	1/2"	25	0.07	63633	----
62634	----	3/4"	25	0.11	63634	----
62635	----	1"	25	0.20	63635	----
62636	----	1-1/4"	25	0.31	63636	----
62637	----	1-1/2"	10	0.44	63637	----
62638	----	2"	10	0.65	63638	----
62640		3"				
		4"	1	2.77	63641	----

HOSE NIPPLE

304 & 316 150#



HOSE BARB X MALE PIPE

PART # 304 S.S.		HOSE I.D. X MALE PIPE	BOX	APPROX. WT. LBS.	PART # 316 S.S.	
73951	----	1/4"	1	0.04	973951	----
73952	----	3/8"	1	0.07	973952	----
73953	----	1/2"	1	0.13	973953	----
73954	----	3/4"	1	0.20	973954	----
73955	----	1"	1	0.33	973955	----
73956	----	1-1/4"	1	0.47	973956	----
73957	----	1-1/2"	1	0.67	973957	----
73958	----	2"	1	0.88	973958	----
73959	----	2-1/2"	1	1.45	973959	----
73960	----	3"	1	1.94	973990	----
73961	----	4"	1	3.57	973991	----

WARNING: This product can expose you to chemicals, including Nickel, which are known to the State of California to cause cancer. For more information, visit www.P65Warnings.ca.gov

304 AND 316 150# SS FITTINGS

NIPPLES AND FITTINGS

REDUCING HOSE NIPPLE

304 150#



HOSE BARB X MALE PIPE

PART # 304 S.S	HOSE I.D. X MALE PIPE	BOX	APPROX. WT. LBS.	
73970	1/4" x 1/8"	1	0.04	----
73971	3/8" x 1/4"	1	0.07	----
73972	1/2" x 3/8"	1	0.13	----
73973	1/2" x 1/4"	1	0.13	----
73974	3/4" x 1/2"	1	0.20	----
73975	1" x 3/4"	1	0.33	----
73976	1" x 1/2"	1	0.33	----
73977	1-1/4" x 1"	1	0.46	----
73979	1-1/2" x 1-1/4"	1	0.66	----
73980	1-1/2" x 1"	1	0.66	----
73981	2" x 1-1/2"	1	0.88	----
73982	2" x 1-1/4"	1	0.88	----

SOLID HEX HEAD PLUG

316 150#



PART # 316 S.S	SIZE	BOX	APPROX. WT. LBS.	
63660	1/8"	25	0.04	----
63661	1/4"	25	0.06	----
63662	3/8"	25	0.08	----
63663	1/2"	25	0.12	----
63664	3/4"	25	0.15	----
63665	1"	25	0.24	----

HEX SOCKET PLUG - BARSTOCK

316 150#



PART # 316 S.S	SIZE	BOX	APPROX. WT. LBS.	
63759	1/16"	1	0.03	----
63760	1/8 "	1	0.05	----
63761	1/4 "	1	0.07	----
63762	3/8 "	1	0.10	----
63763	1/2 "	1	0.14	----
63764	3/4 "	1	0.21	----
63765	1"	1	0.24	----

SOLID SQUARE HEAD PLUG

316 150#



PART # 316 S.S	SIZE	BOX	APPROX. WT. LBS.	
63680	1/8"	25	0.04	----
63681	1/4"	25	0.04	----
63682	3/8"	25	0.05	----
63683	1/2"	25	0.06	----
63684	3/4"	25	0.12	----

WARNING: This product can expose you to chemicals, including Nickel, which are known to the State of California to cause cancer.
 For more information, visit www.P65Warnings.ca.gov

NIPPLES & FITTINGS

BLACK AND GALVANIZED SCH 40

NIPPLES AND FITTINGS

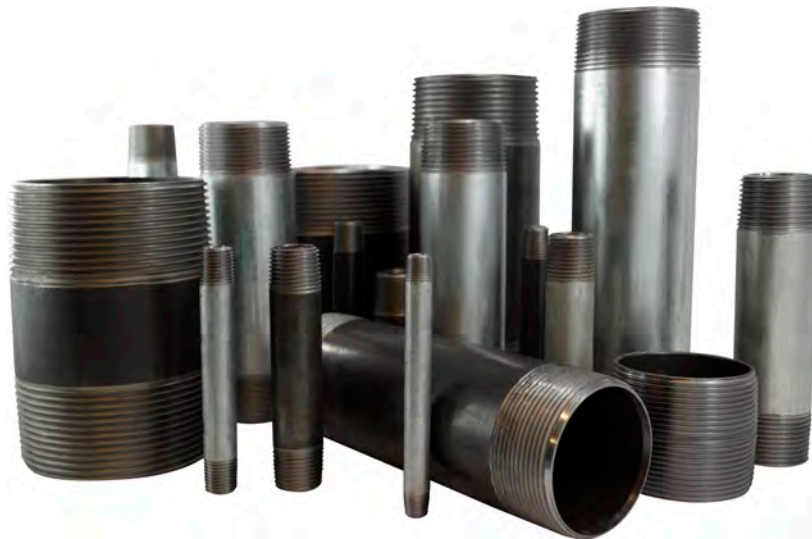

BLACK AND GALVANIZED STEEL NIPPLES

Product Specifications

Welded steel pipe nipples both galvanized and black in diameters ranging from 1/8" up to 4" in lengths from close to 12" and cut-pipe up to 120" -200°-150° Temp Rating.

Technical Specifications

Standards: Product complies with ASTM A-53, A-733 and ANSI B1.20.1 for threading, dimensions and pipe specifications.

Pipe: Complies with ASTM A-53 mill tested schedule 40 and 80 for both Welded & Seamless Meets ANSI B36.1. All pipe is hydrostatic tested. For pressure ratings, see the knowledge bank on our website.

Galvanized: Zinc coating applied by hot dipped. Galvanized complying with ASTM A-123, NSF approved, RoHS compliant.

Black: Protected against oxidation with varnish coating.

Cutting Procedure: All pipe is roller cut. A visual inspection of seams, excessive galvanizing, mid-welds, poor galvanizing, bends, roundness, under and over weight of the pipe is made at the time it is cut. This is done for every length of pipe. Pipe lengths are cut to a tolerance of + or - 1/16" of the actual length.

Threading Procedure:

All pipe is chaser thread cut to American Standard Tapered Pipe Thread standards. This is 3/4" taper per foot. Pipe is visually inspected for roundness of threads and other visual faults as it is removed from the threading machine.

SCHEDULE 80 XXS SEAMLESS



- ASTM A106 Grade B Seamless Pipe
- ASTM A 53
- WVN 351
- Standard NPT Tapered Pipe Threads as per ANSI B 1.20.1 Specification

XXS SEAMLESS



WARNING: This product can expose you to chemicals, including Nickel, which are known to the State of California to cause cancer. For more information, visit www.P65Warnings.ca.gov



PRICING FILE AVAILABLE ONLINE

BLACK AND GALVANIZED SCH 40

NIPPLES AND FITTINGS

1/8" - 27

Wall Thickness 0.068 - Grade B - Test Pressure
700 PSI - Thread Length 0.39



**1/8" DIAMETER
SCH 40 WELDED**



PART # GALV		LENGTH	BOX/CASE	APPROX. WT. LBS.	PART # BLACK	
56001	----	X Close (3/4")	50/600	0.02	57001	----
56002	----	x 1-1/2"	50/600	0.03	57002	----
56003	----	x 2"	50/500	0.04	57003	----
56004	----	x 2-1/2"	100/400	0.06	57004	----
56005	----	x 3"	50/300	0.07	57005	----
56006	----	x 3-1/2"	50/300	0.08	57006	----
56007	----	x 4"	50/300	0.09	57007	----
56008	----	x 4-1/2"	50/300	0.10	57008	----
56009	----	x 5"	50/300	0.11	57009	----
56010	----	x 5-1/2"	50/300	0.12	57010	----
56011	----	x 6"	50/300	0.13	57011	----
56012	----	x 7"	50/300	0.15	57012	----
56013	----	x 8"	50/300	0.18	57013	----
56014	----	x 9"	50/300	0.21	57014	----
56015	----	x 10"	50/300	0.25	57015	----
56017	----	x 12"	50/300	0.29	57017	----

1/4"-18

Wall Thickness 0.068 - Grade B - Test Pressure
700 PSI - Thread Length 0.39



**1/4" DIAMETER
SCH 40 WELDED**



PART # GALV		LENGTH	BOX/CASE	APPROX. WT. LBS.	PART # BLACK	
56020	----	X Close (7/8")	50/600	0.04	57020	----
56021	----	x 1-1/2"	125/500	0.06	57021	----
56022	----	x 2"	125/500	0.06	57022	----
56023	----	x 2-1/2"	100/400	0.08	57023	----
56024	----	x 3"	50/300	0.10	57024	----
56025	----	x 3-1/2"	50/300	0.12	57025	----
56026	----	x 4"	50/300	0.14	57026	----
56027	----	x 4-1/2"	50/300	0.17	57027	----
56028	----	x 5"	50/300	0.19	57028	----
56029	----	x 5-1/2"	50/300	0.21	57029	----
56030	----	x 6"	50/300	0.23	57030	----
56031	----	x 7"	50/100	0.27	57031	----
56032	----	x 8"	50/100	0.31	57032	----
56033	----	x 9"	50/100	0.35	57033	----
56034	----	x 10"	50/100	0.40	57034	----
56035	----	x 11"	50/100	0.44	57035	----
56036	----	x 12"	50/100	0.48	57036	----
56038	----	x 18"	50/100	0.54		

WARNING: This product can expose you to chemicals, including Nickel, which are known to the State of California to cause cancer.
 For more information, visit www.P65Warnings.ca.gov

NIPPLES & FITTINGS

BLACK AND GALVANIZED SCH 40

NIPPLES AND FITTINGS



3/8" DIAMETER SCH 40 WELDED

Wall Thickness 0.091 - Grade B
- Test Pressure 700 PSI - Thread
Length 0.6



PART # GALV	LENGTH	BOX/CASE	APPROX. WT. LBS.	PART # BLACK
56040	X Close (1")	50/600	0.05	57040
56041	x 1-1/2"	125/500	0.07	57041
56042	x 2"	125/500	0.08	57042
56043	x 2-1/2"	100/400	0.11	57043
56044	x 3"	50/300	0.13	57044
56045	x 3-1/2"	50/300	0.16	57045
56046	x 4"	50/300	0.19	57046
56047	x 4-1/2"	50/200	0.21	57047
56048	x 5"	50/150	0.24	57048
56049	x 5-1/2"	50/150	0.27	57049
56050	x 6"	50/100	0.29	57050
56051	x 7"	50/100	0.35	57051
56052	x 8"	50/100	0.40	57052
56053	x 9"	50/100	0.45	57053
56054	x 10"	50/100	0.51	57054
56055	x 11"	50/100	0.56	57055
56056	x 12"	50/100	0.62	57056
56430	x 18"	5/10	0.71	57430
	x 24"	1/1	1.02	57431



1/2" DIAMETER SCH 40 WELDED

Wall Thickness 0.109 -
Grade B - Test Pressure 700
PSI - Thread Length 0.78



PART # GALV	LENGTH	BOX/CASE	APPROX. WT. LBS.	PART # BLACK
56060	X Close (1-1/8")	50/600	0.08	57060
56061	x 1-1/2"	125/500	0.08	57061
56062	x 2"	125/500	0.12	57062
56063	x 2-1/2"	100/400	0.15	57063
56064	x 3"	50/300	0.19	57064
56065	x 3-1/2"	50/300	0.23	57065
56066	x 4"	50/300	0.27	57066
56067	x 4-1/2"	50/200	0.30	57067
56068	x 5"	50/150	0.34	57068
56069	x 5-1/2"	50/150	0.38	57069
56070	x 6"	50/100	0.42	57070
56071	x 7"	50/100	0.49	57071
56072	x 8"	50/100	0.57	57072
56073	x 9"	50/100	0.65	57073
56074	x 10"	50/100	0.72	57074
56075	x 11"	50/100	0.80	57075
56076	x 12"	40/80	0.87	57076
56240	x 18"	1/3	1.29	57240
56241	x 24"	1/3	1.74	57241
56242	x 30"	1/3	2.16	57242
56243	x 36"	1/3	2.61	57243
56244	x 42"	1/3	3.03	57244
56245	x 48"	1/3	3.48	57245
56246	x 60"	1/3	4.35	57246
56247	x 72"	1/3	5.22	57247

WARNING: This product can expose you to chemicals, including Nickel, which are known to the State of California to cause cancer.
 For more information, visit www.P65Warnings.ca.gov

BLACK AND GALVANIZED SCH 40

NIPPLES AND FITTINGS

3/4" DIAMETER SCH 40 WELDED



Wall Thickness 0.113 -
Grade B - Test Pressure
700 PSI - Thread Length
0.79



Part # Galv		Length	Box/Case	Approx. Wt. Lbs.	Part # Black	
56080	----	X Close (1-3/8")	50/300	0.13	57080	----
56081	----	x 1-1/2"	125/250	0.10	57081	----
56082	----	x 2"	125/250	0.15	57082	----
56083	----	x 2-1/2"	50/250	0.20	57083	----
56084	----	x 3"	50/200	0.24	57084	----
56085	----	x 3-1/2"	50/150	0.29	57085	----
56086	----	x 4"	50/150	0.34	57086	----
56087	----	x 4-1/2"	50/150	0.39	57087	----
56088	----	x 5"	50/150	0.43	57088	----
56089	----	x 5-1/2"	60/120	0.48	57089	----
56090	----	x 6"	50/100	0.53	57090	----
56091	----	x 7"	50/100	0.63	57091	----
56092	----	x 8"	50/100	0.72	57092	----
56093	----	x 9"	40/80	0.82	57093	----
56094	----	x 10"	40/80	0.91	57094	----
56095	----	x 11"	30/60	1.01	57095	----
56096	----	x 12"	30/60	1.10	57096	----
56250	----	x 18"	1/3	1.63	57250	----
56251	----	x 24"	1/3	2.20	57251	----
56252	----	x 30"	1/3	2.73	57252	----
56253	----	x 36"	1/3	3.30	57253	----
56254	----	x 42"	1/3	3.83	57254	----
56255	----	x 48"	1/3	4.40	57255	----
56256	----	x 60"	1/3	5.50	57256	----
56257	----	x 72"	1/3	6.60	57257	----

WARNING: This product can expose you to chemicals, including Nickel, which are known to the State of California to cause cancer. For more information, visit www.P65Warnings.ca.gov

NIPPLES & FITTINGS

BLACK AND GALVANIZED SCH 40

NIPPLES AND FITTINGS



1" DIAMETER SCH 40 WELDED

Wall Thickness 0.133 - Grade
B - Test Pressure 700 PSI -
Thread Length 0.98



PART # GALV		LENGTH	BOX/CASE	APPROX. WT. LBS.	PART # BLACK	
56100	----	X Close (1-1/2")	50/200	0.16	57100	----
56101	----	x 2"	50/150	0.23	57101	----
56102	----	x 2-1/2"	50/150	0.29	57102	----
56103	----	x 3"	50/100	0.36	57103	----
56104	----	x 3-1/2"	50/100	0.43	57104	----
56105	----	x 4"	50/100	0.50	57105	----
56106	----	x 4-1/2"	50/100	0.56	57106	----
56107	----	x 5"	50/100	0.63	57107	----
56108	----	x 5-1/2"	50/100	0.70	57108	----
56109	----	x 6"	40/80	0.77	57109	----
56110	----	x 7"	25/50	0.90	57110	----
56111	----	x 8"	25/50	1.03	57111	----
56112	----	x 9"	15/30	1.17	57112	----
56113	----	x 10"	15/30	1.30	57113	----
56114	----	x 11"	15/30	1.44	57114	----
56115	----	x 12"	15/30	1.57	57115	----
56260	----	x 18"	1/3	2.34	57260	----
56261	----	x 24"	1/3	3.14	57261	----
56262	----	x 30"	1/3	3.91	57262	----
56263	----	x 36"	1/3	4.71	57263	----
56264	----	x 42"	1/3	5.48	57264	----
56265	----	x 48"	1/3	6.28	57265	----
56266	----	x 60"	1/3	7.85	57266	----
56267	----	x 72"	1/3	9.42	57267	----

WARNING: This product can expose you to chemicals, including Nickel, which are known to the State of California to cause cancer. For more information, visit www.P65Warnings.ca.gov



BLACK AND GALVANIZED SCH 40

NIPPLES AND FITTINGS



1-1/4" DIAMETER SCH 40 WELDED

Wall Thickness 0.14 - Grade
B - Test Pressure 1300 PSI -
Thread Length 1.01



PART # GALV	LENGTH	BOX/CASE	APPROX. WT. LBS.	PART # BLACK
56120	X Close (1-5/8")	50/100	0.25	57120
56121	x 2"	50/100	0.32	57121
56122	x 2-1/2"	50/100	0.41	57122
56123	x 3"	50/100	0.50	57123
56124	x 3-1/2"	30/60	0.60	57124
56125	x 4"	30/60	0.69	57125
56126	x 4-1/2"	30/60	0.78	57126
56127	x 5"	25/50	0.87	57127
56128	x 5-1/2"	25/50	0.96	57128
56129	x 6"	25/50	1.06	57129
56130	x 7"	15/30	1.24	57130
56131	x 8"	15/30	1.42	57131
56132	x 9"	15/30	1.61	57132
56133	x 10"	15/30	1.79	57133
56134	x 11"	10/20	1.97	57134
56135	x 12"	10/20	2.16	57135
56270	x 18"	1/3	3.22	57270
56271	x 24"	1/3	4.32	57271
56272	x 30"	1/3	3.22	57272
56273	x 36"	1/3	6.48	57273
56275	x 48"			57275
	x 48"	1/3	8.64	57275
56276	x 60"	1/3	10.80	57276



1-1/2" DIAMETER SCH 40 WELDED

Wall Thickness 0.145 - Grade
B - Test Pressure 1300 PSI -
Thread Length 1.03



PART # GALV	LENGTH	BOX/CASE	APPROX. WT. LBS.	PART # BLACK
56140	X Close (1-3/4")	50/100	0.31	57140
56141	x 2"	40/80	0.37	57141
56142	x 2-1/2"	40/80	0.47	57142
56143	x 3"	40/80	0.58	57143
56144	x 3-1/2"	25/50	0.68	57144
56145	x 4"	25/50	0.78	57145
56146	x 4-1/2"	25/50	0.89	57146
56147	x 5"	25/50	1.10	57147
56148	x 5-1/2"	20/40	1.10	57148
56149	x 6"	15/30	1.20	57149
56150	x 7"	15/30	1.41	57150
56151	x 8"	15/30	1.62	57151
56152	x 9"	15/30	1.83	57152
56153	x 10"	1/20	2.04	57153
56154	x 11"	1/20	2.25	57154
56155	x 12"	1/20	2.46	57155
56280	x 18"	1/3	3.66	57280
56281	x 24"	1/3	4.92	57281
56282	x 30"	1/3	6.12	57282
56283	x 36"	1/3	7.38	57283
56285	x 48"	1/3	9.84	57285
56286	x 60"			57286

WARNING: This product can expose you to chemicals, including Nickel, which are known to the State of California to cause cancer.
 For more information, visit www.P65Warnings.ca.gov



BLACK AND GALVANIZED SCH 40

NIPPLES AND FITTINGS



2" DIAMETER SCH 40 WELDED

Wall Thickness 0.154 - Grade
B - Test Pressure 2500 PSI -
Thread Length 1.06



PART # GALV		LENGTH	BOX/CASE	APPROX. WT. LBS.	PART # BLACK	
56160	----	X Close (2")	40/80	0.55	57160	----
56161	----	x 2-1/2"	25/50	0.70	57161	----
56162	----	x 3"	25/50	0.86	57162	----
56163	----	x 3-1/2"	1/30	1.01	57163	----
56164	----	x 4"	1/30	1.16	57164	----
56165	----	x 4-1/2"	1/25	1.31	57165	----
56166	----	x 5"	1/30	1.47	57166	----
56167	----	x 5-1/2"	1/30	1.62	57167	----
56168	----	x 6"	1/20	1.77	57168	----
56169	----	x 7"	1/20	2.08	57169	----
56170	----	x 8"	1/20	2.39	57170	----
56171	----	x 9"	1/10	2.70	57171	----
56172	----	x 10"	1/10	3.00	57172	----
56173	----	x 11"	1/10	3.31	57173	----
56174	----	x 12"	1/10	3.62	57174	----
56290	----	x 18"	1/3	5.39	57290	----
56291	----	x 24"	1/3	5.26	57291	----
56292	----	x 30"	1/3	7.03	57292	----
56293	----	x 36"	1/3	10.86	57293	----
56294	----	x 42"	1/3	12.63	57294	----
56295	----	x 48"	1/3	14.48	57295	----
56296	----	x 60"	1/3	18.10	57296	----
56297	----	x 72"	1/3	18.10	57297	----



2-1/2" DIAMETER SCH 40 WELDED

Wall Thickness 0.203 - Grade
B - Test Pressure 2500 PSI -
Thread Length 1.57



PART # GALV		LENGTH	BOX/CASE	APPROX. WT. LBS.	PART # BLACK	
56180	----	X Close (2-1/2")	1/20	1.09	57180	----
56181	----	x 3"	1/20	1.33	57181	----
56182	----	x 3-1/2"	1/20	1.57	57182	----
56183	----	x 4"	1/20	1.82	57183	----
56184	----	x 4-1/2"	1/20	2.06	57184	----
56185	----	x 5"	1/20	2.30	57185	----
56186	----	x 5-1/2"	1/10	2.54	57186	----
56187	----	x 6"	1/10	2.78	57187	----
56188	----	x 7"	1/10	3.27	57188	----
56189	----	x 8"	1/10	3.75	57189	----
56190	----	x 9"	1/10	4.24	57190	----
56191	----	x 10"	1/8	4.72	57191	----
56192	----	x 11"	1/8	5.21	57192	----
56193	----	x 12"	1/8	5.69	57193	----

WARNING: This product can expose you to chemicals, including Nickel, which are known to the State of California to cause cancer.
 For more information, visit www.P65Warnings.ca.gov



BLACK AND GALVANIZED SCH 40

NIPPLES AND FITTINGS



3" DIAMETER SCH 40 WELDED

Wall Thickness 0.216 - Grade
B - Test Pressure 2500 PSI -
Thread Length 1.64



PART # GALV		LENGTH	BOX/CASE	APPROX. WT. LBS.	PART # BLACK	
56200	----	X Close (2-5/8")	1/20	1.52	57200	----
56201	----	x 3"	1/20	1.76	57201	----
56202	----	x 3-1/2"	1/10	2.08	57202	----
56203	----	x 4"	1/10	2.39	57203	----
56204	----	x 4-1/2"	1/10	2.71	57204	----
56205	----	x 5"	1/10	3.03	57205	----
56206	----	x 5-1/2"	1/10	3.35	57206	----
56207	----	x 6"	1/10	3.66	57207	----
56208	----	x 7"	1/8	4.30	57208	----
56209	----	x 8"	1/8	4.93	57209	----
56210	----	x 9"	1/8	5.57	57210	----
56211	----	x 10"	1/5	6.20	57211	----
56212	----	x 11"	1/5	7.20	57212	----
56213	----	x 12"	1/5	7.47	57213	----
		x 24"	1	14.94	57311	----



4" DIAMETER SCH 40 WELDED

Wall Thickness 0.237 - Grade
B - Test Pressure 2210 PSI -
Thread Length 1.74



PART # GALV		LENGTH	BOX/CASE	APPROX. WT. LBS.	PART # BLACK	
56220	----	X Close (2-7/8")	1/10	2.00	57220	----
56221	----	3-1/2"	1/8	2.21		
56223	----	x 4"	1/8	3.41	57223	----
56224	----	x 4-1/2"	1/6	3.86	57224	----
56225	----	x 5"	1/6	4.31	57225	----
56226	----	x 5-1/2"	1/6	4.76	57226	----
56227	----	x 6"	1/6	5.21	57227	----
56330	----	x 7"	1/5	6.48	57330	----
56229	----	x 8"	1/5	7.01	57229	----
56331	----	x 9"	1/5	7.54	57331	----
56332	----	x 10"	1/5	8.14	57332	----
56228	----	x 12"	1/4	8.54	57228	----



VIEW PRICING AND AVAILABLE STOCK ONLINE

WARNING: This product can expose you to chemicals, including Nickel, which are known to the State of California to cause cancer.
 For more information, visit www.P65Warnings.ca.gov

NIPPLES & FITTINGS

NIPPLES AND ASSORTMENTS

NIPPLES AND FITTINGS



6" DIAMETER SCH 40 WELDED

Wall Thickness 0.154 - Grade
B - Test Pressure 2500 PSI -
Thread Length 1.06



PART # GALV		LENGTH	BOX/CASE	APPROX. WT. LBS.	PART # BLACK	
56300	----	X Close (3-1/8")	1/1	3.80	57300	----
		x 4"	1/1	5.30	57304	----
		x 6"	1/1	8.30	57301	----
		x 8"	1/1	11.30	57305	----
		x 10"			57306	----
		x 12"	1/1	17.20	57308	----



8" DIAMETER SCH 40 WELDED

Wall Thickness 0.154 - Grade
B - Test Pressure 2500 PSI -
Thread Length 1.06

PART #	LENGTH	BOX/CASE	APPROX. WT. LBS.	
57320	X Close (3-1/8")	1/1	5.80	----
57322	x 6"	1/1	6.50	----
57324	x 8"	1/1	11.30	----
57326	x 10"	1/1	19.00	----
57328	x 12"	1/1	28.55	----



SCH 40 SINGLE RUN NIPPLE BLACK

PART	DESCRIPTION	CLOSE	1-1/2	2	2-1/2	3	3-1/2	4	4-1/2	5	5 1/2	6	TOTAL PCS	LIST
973570	1/2"	1	1	1	1	1	1	1	1	1	1	1	11	
973571	3/4"	1	1	1	1	1	1	1	1	1	1	1	11	
973572	1"	1		1	1	1	1	1	1	1	1	1	10	
973573	1-1/4"	1		1	1	1	1	1	1	1	1	1	10	
973574	1-1/2"	1		1	1	1	1	1	1	1	1	1	10	
973575	2"	1			1	1	1	1	1	1	1	1	9	

SCH 40 SINGLE RUN NIPPLE GALVANIZED

PART	DESCRIPTION	CLOSE	1-1/2	2	2-1/2	3	3-1/2	4	4-1/2	5	5 1/2	6	TOTAL PCS	LIST
973670	1/2"	1	1	1	1	1	1	1	1	1	1	1	11	
973671	3/4"	1	1	1	1	1	1	1	1	1	1	1	11	
973672	1"	1		1	1	1	1	1	1	1	1	1	10	
973673	1-1/4"	1		1	1	1	1	1	1	1	1	1	10	
973674	1-1/2"	1		1	1	1	1	1	1	1	1	1	10	
973675	2"	1			1	1	1	1	1	1	1	1	9	

WARNING: This product can expose you to chemicals, including Nickel, which are known to the State of California to cause cancer.
 For more information, visit www.P65Warnings.ca.gov

NIPPLES AND ASSORTMENTS

NIPPLES AND FITTINGS

STEEL NIPPLE ASSORTMENTS

B "6" ASSORTMENTS



BLACK		LENGTH											WT. LBS.	TOTAL PIECES		
		CLOSE	1-1/2"	2"	2-1/2"	3"	3-1/2"	4"	4-1/2"	5"	5-1/2"	6"				
973567	1/2"	6	6	6	6	6	6	6	6	6	6	6	6	20	66	----
973568	3/4"	6	6	6	6	6	6	6	6	6	6	6	6	27	66	----
973569	1"	6		6	6	6	6	6	6	6	6	6	6	34	60	----

GALV.		LENGTH											WT. LBS.	TOTAL PIECES		
		CLOSE	1-1/2"	2"	2-1/2"	3"	3-1/2"	4"	4-1/2"	5"	5-1/2"	6"				
973667	1/2"	6	6	6	6	6	6	6	6	6	6	6	6	20	66	----
973668	3/4"	6	6	6	6	6	6	6	6	6	6	6	6	27	66	----
973669	1"	6		6	6	6	6	6	6	6	6	6	6	34	60	----

STEEL TOTE TRAYS



PART #	SIZE	CAPACITY	
990781	1/2"	77pcs	----
990782	3/4"	66pcs	----
990783	1"	50pcs	----
990786	1-1/4"	40pcs	----
990784	1-1/2"	30pcs	----
990785	2"	27pcs	----

WARNING: This product can expose you to chemicals, including Nickel, which are known to the State of California to cause cancer. For more information, visit www.P65Warnings.ca.gov

NIPPLES & FITTINGS

BLACK SCH 80 SEAMLESS

NIPPLES AND FITTINGS

EXTRA HEAVY SEAMLESS STEEL PIPE NIPPLES

1/8" - 27



1/8" DIAMETER SCHEDULE 80 SEAMLESS

Wall Thickness 0.094 - Grade B - Test Pressure 850 PSI - Thread Length 0.39

PART #	LENGTH	BOX/CASE	APPROX. WT. LBS.	
59001SMLS	x Close	40/480	0.02	----
59002SMLS	x 1-1/2"	40/480	0.03	----
59003SMLS	x 2"	100/400	0.05	----
59004SMLS	2-1/2"	100/400	0.06	----
59005SMLS	x 3"	40/240	0.08	----
59006SMLS	x 3-1/2"	40/240	0.09	----
59007SMLS	x 4"	40/240	0.11	----
59009SMLS	x 5"	40/120	0.12	----
59010SMLS	x 5-1/2"	40/120	0.13	----
59011SMLS	x 6"	40/80	0.16	----

1/4" - 18



1/4" DIAMETER SCHEDULE 80 SEAMLESS

Wall Thickness 0.119 - Grade B - Test Pressure 850 PSI - Thread Length 0.59

PART #	LENGTH	BOX/CASE	APPROX. WT. LBS.	
59020SMLS	x Close (7/8")	40 / 480	0.03	----
59021SMLS	x 1-1/2"	100 / 400	0.06	----
59022SMLS	x 2"	100 / 400	0.08	----
59023SMLS	x 2-1/2"	80 / 320	0.10	----
59024SMLS	x 3"	40 / 240	0.12	----
59025SMLS	x 3-1/2"	40 / 240	0.15	----
59026SMLS	x 4"	40 / 240	0.17	----
59027SMLS	x 4-1/2"	40 / 120	0.19	----
59028SMLS	x 5"	40 / 120	0.21	----
59029SMLS	x 5-1/2"	40 / 80	0.24	----
59030SMLS	x 6"	40 / 80	0.26	----
59031SMLS	x 7"	40 / 80	0.30	----
59032SMLS	x 8"	40 / 80	0.35	----
59033SMLS	x 9"	40 / 80	0.39	----
59034SMLS	x 10"	40 / 80	0.44	----
59036SMLS	x 12"	40 / 80	0.53	----

WARNING: This product can expose you to chemicals, including Nickel, which are known to the State of California to cause cancer. For more information, visit www.P65Warnings.ca.gov



BLACK SCH 80 SEAMLESS

NIPPLES AND FITTINGS

3/8" - 18



3/8" DIAMETER SCHEDULE 80 SEAMLESS

Wall Thickness 0.126 - Grade B - Test Pressure 850 PSI - Thread Length 0.6

PART #	LENGTH	BOX/CASE	APPROX. WT. LBS.	
59040SMLS	X Close (3/8")	40 / 480	0.05	----
59041SMLS	x 1-1/2"	100 / 400	0.08	----
59042SMLS	x 2"	100 / 400	0.11	----
59043SMLS	x 2-1/2"	80 / 320	0.14	----
59044SMLS	x 3"	40 / 240	0.17	----
59045SMLS	x 3-1/2"	40 / 240	0.20	----
59046SMLS	x 4"	40 / 240	0.23	----
59047SMLS	x 4-1/2"	40 / 160	0.26	----
59048SMLS	x 5"	40 / 120	0.29	----
59049SMLS	x 5-1/2"	40 / 120	0.32	----
59050SMLS	x 6"	40 / 80	0.35	----
59052SMLS	x 8"	40/80	0.47	----
59054SMLS	x 10"	40/80	0.53	----
59056SMLS	x 12"	40/80	0.65	----

1/2" - 14



1/2" DIAMETER SCHEDULE 80 SEAMLESS

Wall Thickness 0.147 - Grade B - Test Pressure 850 PSI - Thread Length 0.78

PART #	LENGTH	BOX/CASE	APPROX. WT. LBS.	
59060SMLS	X Close (1-1/8")	40 / 480	0.07	----
59061SMLS	x 1-1/2"	100 / 400	0.11	----
59062SMLS	x 2"	100 / 400	0.15	----
59063SMLS	x 2-1/2"	80 / 320	0.20	----
59064SMLS	x 3"	40 / 240	0.24	----
59065SMLS	x 3-1/2"	40 / 240	0.29	----
59066SMLS	x 4"	40 / 240	0.33	----
59067SMLS	x 4-1/2"	40 / 160	0.38	----
59068SMLS	x 5"	40 / 120	0.42	----
59069SMLS	x 5-1/2"	40 / 120	0.47	----
59070SMLS	x 6"	40 / 80	0.51	----
59071SMLS	x 7"	40 / 80	0.60	----
59072SMLS	x 8"	40 / 80	0.69	----
59073SMLS	x 9"	40/80	0.73	----
59074SMLS	x 10"	40 / 80	0.88	----
59075SMLS	x 11"	32/64	0.96	----
59076SMLS	x 12"	32 / 64	1.06	----

See our website for Schedule 80 Welded Black and Galvanized Steel Nipples

BLACK SCH 80 SEAMLESS

NIPPLES AND FITTINGS



3/4" - 14

3/4" DIAMETER SCHEDULE 80 SEAMLESS

Wall Thickness 0.154 - Grade B - Test Pressure 850 PSI - Thread Length 0.79

PART #	LENGTH	BOX/CASE	APPROX. WT. LBS.	
59080SMLS	X Close (1-3/8")	40/240	0.13	----
59081SMLS	x 1-1/2"	100/200	0.15	----
59082SMLS	x 2"	100/200	0.21	----
59083SMLS	x 2-1/2"	40/160	0.27	----
59084SMLS	x 3"	40/160	0.33	----
59085SMLS	x 3-1/2"	40/120	0.39	----
59086SMLS	x 4"	40/120	0.45	----
59087SMLS	x 4-1/2"	40/120	0.51	----
59088SMLS	x 5"	40/120	0.57	----
59089SMLS	x 5-1/2"	48/96	0.64	----
59090SMLS	x 6"	40/80	0.69	----
59091SMLS	x 7"	40/80	0.82	----
59092SMLS	x 8"	40/80	0.94	----
59094SMLS	x 10"	32/64	1.19	----
59096SMLS	x 12"	24/48	1.44	----



1" - 11 1/2

1" DIAMETER SCHEDULE 80 SEAMLESS

Wall Thickness 0.179 - Grade B - Test Pressure 850 PSI - Thread Length 0.98

PART #	LENGTH	BOX/CASE	APPROX. WT. LBS.	
59100SMLS	X Close (1-1/2")	40 / 160	0.21	----
59101SMLS	x 2"	40 / 120	0.30	----
59102SMLS	x 2-1/2"	40 / 120	0.37	----
59103SMLS	x 3"	40 / 80	0.47	----
59104SMLS	x 3-1/2"	40 / 80	0.56	----
59105SMLS	x 4"	40 / 80	0.65	----
59106SMLS	x 4-1/2"	40 / 80	0.74	----
59107SMLS	x 5"	40 / 80	0.83	----
59108SMLS	x 5-1/2"	40 / 80	0.92	----
59109SMLS	x 6"	32 / 64	1.01	----
59110SMLS	x 7"	20 / 40	1.19	----
59111SMLS	x 8"	20 / 40	1.37	----
59112SMLS	x 9"	20 / 40	1.55	----
59113SMLS	x 10"	12 / 24	1.74	----
59114SMLS	x 11"	12 / 24	1.92	----
59115SMLS	x 12"	12 / 24	2.10	----

WARNING: This product can expose you to chemicals, including Nickel, which are known to the State of California to cause cancer. For more information, visit www.P65Warnings.ca.gov



BLACK SCH 80 SEAMLESS

NIPPLES AND FITTINGS



1-1/4" DIAMETER SCHEDULE 80 SEAMLESS

Wall Thickness 0.191 - Grade B - Test Pressure 1900 PSI - Thread Length 1.01

PART #	LENGTH	BOX/CASE	APPROX. WT. LBS.	
59120SMLS	X Close (1-5/8")	40 / 80	0.31	----
59121SMLS	x 2"	40 / 80	0.42	----
59122SMLS	x 2-1/2"	40 / 80	0.52	----
59123SMLS	x 3"	40 / 80	0.64	----
59124SMLS	x 3-1/2"	24 / 48	0.77	----
59125SMLS	x 4"	24 / 48	0.90	----
59126SMLS	x 4-1/2"	24 / 48	1.02	----
59127SMLS	x 5"	20 / 40	1.15	----
59128SMLS	x 5-1/2"	20 / 40	1.27	----
59129SMLS	x 6"	20 / 40	1.40	----
59130SMLS	x 7"	20 / 40	1.65	----
59131SMLS	x 8"	12 / 24	1.90	----
59132SMLS	x 9"	12 / 24	2.15	----
59133SMLS	x 10"	12 / 24	2.40	----
59134SMLS	x 11"	8 / 16	2.65	----
59135SMLS	x 12"	8 / 16	2.90	----



1-1/2" DIAMETER SCHEDULE 80 SEAMLESS

Wall Thickness 0.2 - Grade B - Test Pressure 1900 PSI - Thread Length 1.03

PART #	LENGTH	BOX/CASE	APPROX. WT. LBS.	
59140SMLS	X Close (1-3/4")	40 / 80	0.41	----
59141SMLS	x 2"	32 / 64	0.51	----
59142SMLS	x 2-1/2"	32 / 64	0.64	----
59143SMLS	x 3"	32 / 64	0.78	----
59144SMLS	x 3-1/2"	20 / 40	0.94	----
59145SMLS	x 4"	20 / 40	1.09	----
59146SMLS	x 4-1/2"	20 / 40	1.23	----
59147SMLS	x 5"	20 / 40	1.39	----
59148SMLS	x 5-1/2"	16 / 32	1.54	----
59149SMLS	x 6"	12 / 24	1.69	----
59150SMLS	x 7"	12 / 24	2.00	----
59151SMLS	x 8"	12 / 24	2.30	----
59152SMLS	x 9"	12 / 24	2.61	----
59153SMLS	x 10"	8 / 16	2.90	----
59154SMLS	x 11"	8 / 16	3.20	----
59155SMLS	x 12"	8 / 16	3.51	----

WARNING: This product can expose you to chemicals, including Nickel, which are known to the State of California to cause cancer. For more information, visit www.P65Warnings.ca.gov

BLACK SCH 80 SEAMLESS

NIPPLES AND FITTINGS



2" DIAMETER SCHEDULE 80 SEAMLESS

Wall Thickness 0.218 - Grade B - Test Pressure 2500 PSI - Thread Length 1.06

PART #	LENGTH	BOX/CASE	APPROX. WT. LBS.	
59160SMLS	X Close (2")	32/64	0.30	----
59161SMLS	x 2-1/2"	20 / 40	0.80	----
59162SMLS	x 3"	20 / 40	1.10	----
59163SMLS	x 3-1/2"	12 / 24	1.31	----
59164SMLS	x 4"	12 / 24	1.52	----
59165SMLS	x 4-1/2"	12 / 24	1.72	----
59166SMLS	x 5"	12 / 24	1.94	----
59167SMLS	x 5-1/2"	12 / 24	2.15	----
59168SMLS	x 6"	8 / 16	2.35	----
59169SMLS	x 7"	8 / 16	2.78	----
59170SMLS	x 8"	8 / 16	3.19	----
59171SMLS	x 9"	1 / 8	3.62	----
59172SMLS	x 10"	1 / 8	4.03	----
59173SMLS	x 11"	1 / 8	4.44	----
59174SMLS	x 12"	1 / 8	4.87	----
59196SMLS	x 18"	1/1	7.22	----
59197SMLS	x 24"	1/1	9.74	----
59198SMLS	x 36"	1/1	14.61	----
59199SMLS	x 48"	1/1	19.48	----



2-1/2" DIAMETER SCHEDULE 80 SEAMLESS

Wall Thickness 0.276 - Grade B - Test Pressure 2500 PSI - Thread Length 1.57

PART #	LENGTH	BOX/CASE	APPROX. WT. LBS.	
59180SMLS	x Close (2-1/2")	1 / 16	1.25	----
59181SMLS	x 3"	1 / 16	1.57	----
59182SMLS	x 3-1/2"	1 / 16	1.82	----
59183SMLS	x 4"	1 / 16	2.15	----
59184SMLS	x 4-1/2"	1 / 16	1.75	----
59185SMLS	x 5"	1 / 16	2.78	----
59186SMLS	x 5-1/2"	1 / 8	2.25	----
59187SMLS	x 6"	1 / 8	3.41	----
59188SMLS	x 7"	1 / 8	3.89	----
59189SMLS	x 8"	1 / 8	4.69	----
59190SMLS	x 9"	1 / 8	5.34	----
59191SMLS	x 10"	1 / 6	5.97	----
59192SMLS	x 11"	1 / 6	4.89	----
59193SMLS	x 12"	1 / 5	7.26	----

WARNING: This product can expose you to chemicals, including Nickel, which are known to the State of California to cause cancer. For more information, visit www.P65Warnings.ca.gov



BLACK SCH 80 SEAMLESS

NIPPLES AND FITTINGS



3" DIAMETER SCHEDULE 80 SEAMLESS

Wall Thickness 0.3 - Grade B - Test Pressure 2500 PSI - Thread Length 1.64

Part #	Length	Box/Case	Approx. Wt. Lbs.	
59-200SMLS	X Close (2-5/8")	1 / 16	1.79	----
59-201SMLS	x 3"	1 / 16	2.11	----
59-202SMLS	x 3-1/2"	1 / 16	2.55	----
59-203SMLS	x 4"	1 / 8	2.89	----
59-204SMLS	x 4-1/2"	1 / 8	3.30	----
59-205SMLS	x 5"	1 / 8	3.73	----
59-206SMLS	x 5-1/2"	1 / 8	4.17	----
59-207SMLS	x 6"	1 / 8	4.57	----
59-208SMLS	x 7"	1 / 6	5.45	----
59-209SMLS	x 8"	1 / 6	6.29	----
59-210SMLS	x 9"	1 / 6	7.17	----
59-211SMLS	x 10"	1 / 4	8.01	----
59-212SMLS	x 11"	1 / 4	8.85	----
59-213SMLS	x 12"	1 / 4	9.72	----



4" DIAMETER SCHEDULE 80 SEAMLESS

Wall Thickness 0.337 - Grade B - Test Pressure 2800 PSI - Thread Length 1.74

PART #	LENGTH	BOX/CASE	APPROX. WT. LBS.	
59220SMLS	X Close (2-7/8")	1 / 8	2.91	----
59221SMLS	x 4"	1 / 6	4.26	----
59223SMLS	x 5"	1 / 5	5.49	----
59224SMLS	x 5-1/2"			
59225SMLS	x 6"	1 / 5	6.72	----
59226SMLS	x 7"	1/3	7.33	----
59227SMLS	x 8"	1 / 3	9.23	----
59228SMLS	9"			
59229SMLS	x 10"	1 / 3	11.73	----
59231SMLS	x 12"	1 / 3	14.24	----

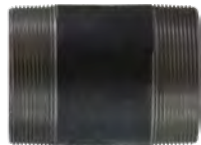

6" DIAMETER

SCHEDULE 80 SEAMLESS



8" DIAMETER

PART #		LENGTH	BOX/CASE	APPROX. WT. LBS.		PART #	
				6"	8"		
59300SMLS	----	X Close	2	3.57	4.62	59-320SMLS	----
59301SMLS	----	x 6"	2	14.29	16.91	59-322SMLS	----
59305SMLS	----	x 8"	2	19.05	22.54	59-324SMLS	----
59306SMLS	----	x 10"	2	23.81	27.47	59-326SMLS	----
59308SMLS	----	x 12"	2	28.57	34.18	59-328SMLS	----

WARNING: This product can expose you to chemicals, including Nickel, which are known to the State of California to cause cancer. For more information, visit www.P65Warnings.ca.gov

NIPPLES & FITTINGS

BLACK EXTRA HEAVY XXS SEAMLESS

NIPPLES AND FITTINGS

NIPPLES & FITTINGS



1/2" DIAMETER BLACK EXTRA HEAVY XXS SEAMLESS

Wall Thickness 0.294 - Grade B - Test Pressure 1000 PSI - Thread Length 0.79

PART #	LENGTH	BOX/CASE	APPROX. WT. LBS.	
59060SMLSXX	x Close	100 / 200	0.31	----
59062SMLSXX	x 2"	100 / 200	0.58	----
59064SMLSXX	x 3"	50 / 100	0.62	----
59066SMLSXX	x 4"	50 / 100	0.66	----
59070SMLSXX	x 6"	25 / 50	0.75	----



3/4" DIAMETER DIAMETER BLACK EXTRA HEAVY XXS SEAMLESS

Wall Thickness 0.308 - Grade B - Test Pressure 1000 PSI - Thread Length 0.79

PART #	LENGTH	BOX/CASE	APPROX. WT. LBS.	
59080SMLSXX	x Close	40/240	0.55	----
59082SMLSXX	x 2"	50 / 100	0.62	----
59086SMLSXX	x 4"	25 / 50	0.68	----
59090SMLSXX	x 6"	25 / 50	0.71	----



1" DIAMETER DIAMETER BLACK EXTRA HEAVY XXS SEAMLESS

Wall Thickness 0.358 - Grade B - Test Pressure 1000 PSI - Thread Length 0.98

PART #	LENGTH	BOX/CASE	APPROX. WT. LBS.	
59100SMLSXX	x close	50 / 100	0.88	----
59101SMLSXX	x 2"	50 / 100	1.07	----
59103SMLSXX	x 3"	20/40	1.10	----
59105SMLSXX	x 4"	20 / 40	1.14	----
59109SMLSXX	x 6"	20 / 40	1.75	----
59111SMLSXX	x 8"	1 / 25	1.88	----
59115SMLSXX	x 12"	1 / 15	2.15	----



2" DIAMETER DIAMETER BLACK EXTRA HEAVY XXS SEAMLESS

Wall Thickness 0.436 - Grade B - Test Pressure 2500 PSI - Thread Length 1.06

PART #	LENGTH	BOX/CASE	APPROX. WT. LBS.	
59160SMLSXX	x close	1 / 25	1.36	----
59161SMLSXX	x 2-1/2"	1 / 20	1.67	----
59162SMLSXX	x 3"	1 / 20	2.09	----
59163SMLSXX	x 3-1/2"	1 / 12	2.51	----
59164SMLSXX	x 4"	1 / 12	2.86	----
59166SMLSXX	x 5"	1/12	3.04	----
59168SMLSXX	x 6"	1 / 11	3.20	----
59169SMLSXX	x 7"	1 / 8	4.35	----
59170SMLSXX	x 8"	1 / 8	5.86	----
59171SMLSXX	x 9"	1 / 8	6.58	----
59172SMLSXX	x 10"	1 / 8	7.31	----
59174SMLSXX	x 12"	1 / 8	9.34	----
59179SMLSXX	x 24"	1 / 1	14.77	----

WARNING: This product can expose you to chemicals, including Nickel, which are known to the State of California to cause cancer. For more information, visit www.P65Warnings.ca.gov



SCH 40 AND SCH 80 GROOVE NIPPLES

NIPPLES AND FITTINGS

THREAD X GROOVE

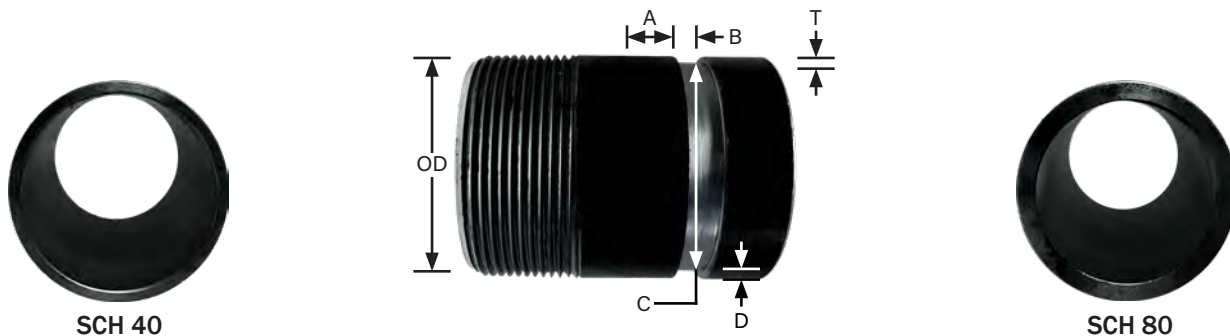

2" DIAMETER							
PART #	LIST PRICE	BOX	WTG	LENGTH	WTG	BOX	PART #
57162TV	----	50	0.70	x 3	1.03	40	59162TV
57164TV	----	30	0.97	x 4	1.40	24	59164TV
57168TV	----	20	1.64	x 6	2.41	16	59168TV
57170TV	----	20	2.15	x 8	3.20	16	59170TV
57172TV	----	10	2.80	x 10	3.65	8	59172TV
57174TV	----	10	3.45	x 12	4.01	8	59174TV

3" DIAMETER							
PART #	LIST PRICE	BOX	WTG	LENGTH	WTG	BOX	PART #
57201TV	----	20	1.26	x 3	2.01	16	59201TV
57203TV	----	10	1.80	x 4	3.01	8	59203TV
57207TV	----	10	3.17	x 6	4.87	8	59207TV
57209TV	----	8	4.13	x 8	5.86	6	59209TV
57211TV	----	5	5.48	x 10	6.19	4	59211TV
57213TV	----	5	6.24	x 12	6.37	4	59213TV

4" DIAMETER							
PART #	LIST PRICE	BOX	WTG	LENGTH	WTG	BOX	PART #
57222TV	----	8	2.40	x 3	4.11	6	59222TV
57223TV	----	8	2.52	x 4	4.15	6	59221TV
57227TV	----	6	4.30	x 6	6.52	5	59225TV
57229TV	----	4	5.63	x 8	7.18	3	59229TV
57332TV	----	4	7.90	x 10	11.74	3	59231TV
57228TV	----	4	8.25	x 12	14.24	3	59227TV

NOMINAL IPS PIPE SIZE	O.D. ACTUAL	GASKET SEAT "A"	GROOVE WIDTH "B"	GROOVE DIAMETER "C"	ACTUAL GROOVE DEPTH "D"
2	2.375	0.625	0.312	2.250	0.062
3	3.500	0.625	0.312	3.344	0.078
4	4.500	0.625	0.375	4.334	0.083



GO ONLINE TO VIEW OPEN ORDERS, ORDER HISTORY, AND TRACKING INFORMATION ON ALL SHIPMENTS

WARNING: This product can expose you to chemicals, including Nickel, which are known to the State of California to cause cancer. For more information, visit www.P65Warnings.ca.gov



BLACK SCH 40 AND SCH 80 SEAMLESS GROOVE NIPPLES

NIPPLES AND FITTINGS

GROOVE X GROOVE

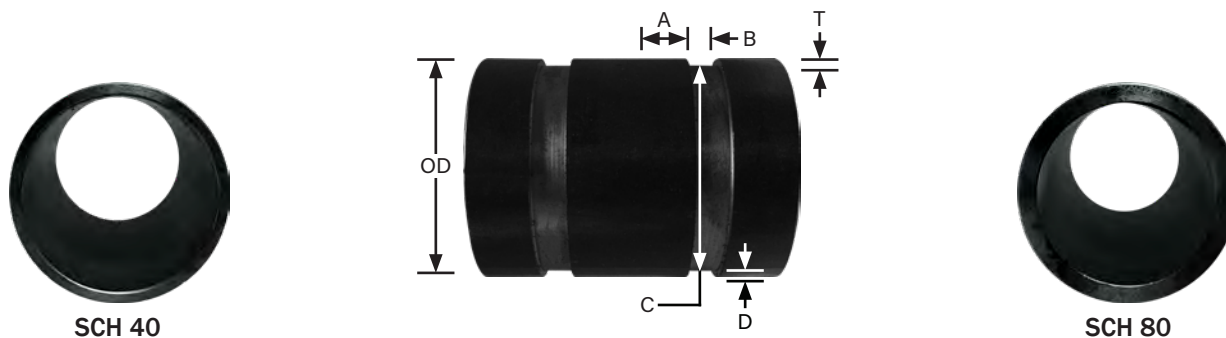

2" DIAMETER							
PART #		BOX	WTG	LENGTH	WTG	BOX	PART #
57162V	----	50	0.70	x 3	1.03	40	59162V
57164V	----	30	0.97	x 4	1.40	24	59164V
57168V	----	20	1.64	x 6	2.41	16	59168V
57170V	----	20	2.15	x 8	3.20	16	59170V
57172V	----	10	2.80	x 10	3.65	8	59172V
57174V	----	10	3.45	x 12	4.01	8	59174V

3" DIAMETER							
PART #		BOX	WTG	LENGTH	WTG	BOX	PART #
57201V	----	20	1.26	x 3	2.01	16	59201V
57203V	----	10	1.80	x 4	3.01	8	59203V
57207V	----	10	3.17	x 6	4.87	8	59207V
57209V	----	8	4.13	x 8	5.86	6	59209V
57211V	----	5	5.48	x 10	6.19	4	59211V
57213V	----	5	6.24	x 12	6.37	4	59213V

4" DIAMETER							
PART #		BOX	WTG	LENGTH	WTG	BOX	PART #
57223V	----	8	2.52	x 4	4.15	6	59221V
57227V	----	6	4.35	x 6	6.52	5	59225V
57229V	----	4	5.63	x 8	7.18	3	59227V
57332V	----	4	7.90	x 10	11.74	3	59229V
57228V	----	4	8.25	x 12	14.24	3	59231V

SEAMLESS SCH 40 GROOVE X BEVEL NIPPLES



PART #	DIA. X LENGTH	
57162GBS	2 x 3	----
57201GBS	3 x 3	----
57222GBS	4 x 3	----
57400GBS	8 x 3	----
57500GBS	10 x 3	----
57600GBS	12 x 3	----

WARNING: This product can expose you to chemicals, including Nickel, which are known to the State of California to cause cancer. For more information, visit www.P65Warnings.ca.gov



MERCHANT COUPLINGS

NIPPLES AND FITTINGS

MERCHANT COUPLINGS

Product Specifications

Welded steel couplings both galvanized and black in diameters from 1/8" up to 4".

Technical Specifications

Standards: Product complies with ASTM A865 and ANSI B1.20.1 for threading, dimensions and pipe specifications. Federal Spec WW-P-404

Pipe: Complies with ASTM A-53 milltested schedule 40 and 80. Meets ANSI B36.1. All pipe is hydrostatic tested.

Galvanized: Zinc coating applied by hot dipping. Galvanized complying with ASTM-A-123.

MERCHANT COUPLINGS



• Straight threads thru 2"

PART # GALV		SIZE	PART # BLACK	
64770	----	1/8"	65770	----
64771	----	1/4"	65771	----
64772	----	3/8"	65772	----
64773	----	1/2"	65773	----
64774	----	3/4"	65774	----
64775	----	1"	65775	----
64776	----	1-1/4"	65776	----
64777	----	1-1/2"	65777	----
64778	----	2"	65778	----
64779	----	2-1/2"	65779	----
64780	----	3"	65780	----
64781	----	4"	65781	----
		5"	65782	----
		6"	65783	----

HALF MERCHANT COUPLINGS



• Straight threads thru 2"

PART # GALV		SIZE	PART # BLACK	
		1/8"	65770H	
		1/4"	65771H	----
		3/8"	65772H	----
64773H	----	1/2"	65773H	----
64774H	----	3/4"	65774H	----
64775H	----	1"	65775H	----
64776H	----	1-1/4"	65776H	----
64777H	----	1-1/2"	65777H	----
64778H	----	2"	65778H	----
		2-1/2"	65779H	----
64780H	----	3"	65780H	----
64781H	----	4"	65781H	----



#304 STAINLESS STEEL MERCHANT COUPLINGS

PART #	SIZE	
61775	1	----
61776	1-1/4	----
61777	1-1/2	----
61778	2	----

Also available:
Extra Heavy Merchant Couplings

MERCHANT COUPLINGS SPECIFICATIONS

SIZE	OUTSIDE DIAM.	LENGTH INCHES	WEIGHT 100 PCS APPROX.		QUANTITY PER BOX	THREADS PER INCH	THREADS TYPE
				POUNDS			
1/8"	.59"	.78		3.5	1000	27	Straight
1/4"	.73"	1.18		7.5	500	18	Straight
3/8"	.86"	1.18"		9	600	18	Straight
1/2"	1.063"	1-9/16"		13.0	100	14	Straight
3/4"	1.313"	1-5/8"		28.3	50	14	Straight
1"	1.576"	2"		40.1	30	11-1/2	Straight
1-1/4"	1.900"	2-1/16"		49.5	25	11-1/2	Straight
1-1/2"	2.17"	2-3/64"		71.48	25	11-1/2	Straight
2"	2.750"	2-1/8"		112.0	20	11-1/2	Straight
2-1/2"	3.250"	3-1/8"		231.2	8	8	Taper Tapped
3"	4.000"	3-1/4"		353.8	5	8	Taper Tapped
4"	5.000"	3-1/2"		471.8	4	8	Taper Tapped
6"	7.32	4"		1000.05	4	8	Taper Tapped

WARNING: This product can expose you to chemicals, including Nickel, which are known to the State of California to cause cancer. For more information, visit www.P65Warnings.ca.gov

API LINE COUPLINGS

A105 BLACK STEEL TAPER TAPPED COUPLINGS

Product Specifications

These couplings are manufactured in accordance with American Petroleum Institute specifications 5L & 5B.

All couplings are phosphated.

All sizes are taper tapped 3/4" per foot on the diameter.

*Certified by the American Petroleum Institute



A105

- Black Steel
- API line API SL

- Each end has a short, unthreaded recess before the threads start.
- Use with sch 80 & sch. 160 nipples & pipe.
- Max. pressure: 3000PSI

API LINE PIPE COUPLINGS

PART #	NPT SIZE	THREADS PER INCH	OUTSIDE DIAMETER	LENGTH	UNIT WEIGHT	
65770API	1/8"	27	0.563	1-1/16	0.04	----
65771API	1/4"	18	0.719	1-5/8	0.10	----
65772API	3/8"	18	0.875	1-5/8	0.13	----
65773API	1/2"	14	1.063	2-1/8	0.24	----
65774API	3/4"	14	1.313	2-1/8	0.35	----
65775API	1"	11.5	1.576	2-5/8	0.52	----
65776API	1-1/4"	11.5	2.054	2-3/4	1.00	----
65777API	1-1/2"	11.5	2.200	2-3/4	0.88	----
65778API	2"	11.5	2.875	2-7/8	1.83	----
65779API	2-1/2"	8	3.375	4-1/8	3.28	----
65780API	3"	8	4.000	4-1/4	4.09	----
65781API	4"	8	5.200	4-1/2	7.59	----
65783API	6"	8	7.390	4-5/8	12.92	----
65784API	8"	8	9.625	5-3/4	23.18	----

I'm sorry, if you were right, I'd agree with you.

- Robin Williams



GO ONLINE TO UPLOAD YOUR LOGO TO UTILIZE ALL OF OUR CUSTOMIZABLE TOOLS!

WARNING: This product can expose you to chemicals, including Nickel, which are known to the State of California to cause cancer. For more information, visit www.P65Warnings.ca.gov



MALLEABLE FITTINGS

NIPPLES AND FITTINGS

MALLEABLE FITTINGS



- Saturated steam pressure 150 PSI @ 350°F
- Max pressure 300 PSI @ 150°F
- Temp range -20°F to 350°F

ISO 9002 - CERTIFICATE OF QUALITY - UL/FM LISTED

Our quality fittings are made with care and attention to detail. With better molds we can reduce parting lines and rough edges resulting in better fluid flow. By using a low temperature galvanizing process the coating is more durable which means a longer lasting fitting. All Fittings are 100% Pressure Tested to 300# Class.

(Every fitting is subjected to an underwater fitness test to ensure the highest quality)

SPECIFICATIONS

- MATERIAL: ASTM A 197 - Cuppla Malleable Iron, ASTM A 153 - Hot dipped galvanizing • Coating ASTM A164 LS
- DIMENSIONS: ANSI B 16.3 - Malleable Iron threaded fittings, ANSI B 16.14 - Ferrous Pipe Plugs, Bushings etc..., ANSI B 16.39 - Malleable Iron threaded pipe unions.
- THREADS: ANSI B 2.1 or BS 21 ASME B1.20.1 • RoHS Compliant • Tapered Threads
- Pressure - Saturated steam 150 PSI @350°F: Max pressure 300 PSI - 150°F
- Temperature range -20 - 350°F

MALLEABLE IRON - ANSI B

F°	16.3			
	Class	Sizes	Sizes	Sizes
	150	1/4-1	1 1/4-2	2 1/4-3
	PSIG	300#	300#	300#
-200-	300	2000	1500	1000
150				
200	265	1785	1350	910
250	225	1575	1200	825
300	185	1360	1050	735
366*	150	1150	900	650

*Permissible for service temperature up to 366°F, reflecting the temperature of saturated steam at 150 psig.

SEE MIDLANDINDUSTRIES.COM FOR MORE SIZES AND CONFIGURATIONS

STEEL FITTINGS



- 1010 Carbon Steel, 3/4 taper threads (see hydraulic section for 7/8 taper threads.)
- Finish or coating • Black Dipped in rust resistant
- Galvanized, Zinc Plated (Inside and Out)

300lb MALLEABLE FITTINGS



Max. pressure: 300 psi WOG @ 72°F; 150 psi WOG saturated steam

- Meet ANSI/ ASME B1.20.1 standards
- Black meet ASTM 197 standards

BULL PLUGS AND SWAGES



FLANGES



WARNING: This product can expose you to chemicals, including Nickel, which are known to the State of California to cause cancer. For more information, visit www.P65Warnings.ca.gov

NIPPLES & FITTINGS

BLACK AND GALVANIZED IRON #150

NIPPLES AND FITTINGS

ELBOWS 90°

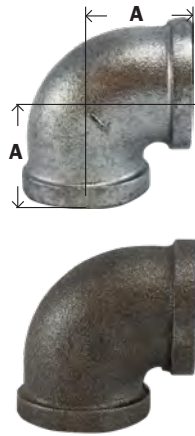

Part # Galvanized		Size	A	Box/Case	Approx. Wt. Lbs.	Part # Black	
64100	----	1/8"	0.69	50/600	0.07	65100	----
64101	----	1/4"	0.81	35/420	0.10	65101	----
64102	----	3/8"	0.95	90/360	0.16	65102	----
64103	----	1/2"	1.12	50/200	0.23	65103	----
64104	----	3/4"	1.31	35/105	0.35	65104	----
64105	----	1"	1.50	20/60	0.57	65105	----
64106	----	1-1/4"	1.75	20/40	0.86	65106	----
64107	----	1-1/2"	1.94	15/30	1.31	65107	----
64108	----	2"	2.25	8/16	1.79	65108	----
64109	----	2-1/2"	2.70	6/12	3.35	65109	----
64110	----	3"	3.08	4/8	5	65110	----
64112	----	4"	3.79	1/2	9.02	65112	----
64114	----	6"	5.13	1/1	23.68	65114	----
		8"			41.1	65115	----

REDUCING ELBOWS 90°

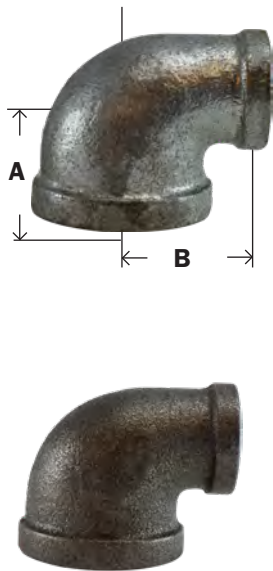

PART # GALVANIZED		SIZE	A	B	BOX/CASE	APPROX. WT. LBS.	PART # BLACK	
64122	----	3/8" x 1/4"	0.88	0.90	90/360	0.16	65122	----
64123	----	1/2" x 1/4"	0.97	0.98	60/240	0.21	65123	----
64124	----	1/2" x 3/8"	1.04	1.03	60/240	0.24	65124	----
64126	----	3/4" x 3/8"	1.12	1.13	40/160	0.31	65126	----
64127	----	3/4" x 1/2"	1.20	1.22	40/160	0.44	65127	----
64130	----	1" x 1/2"	1.26	1.40	25/100	0.52	65130	----
64131	----	1" x 3/4"	1.37	1.45	50/100	0.58	65131	----
64133	----	1-1/4" x 3/4"	1.45	1.62	15/120	0.79	65133	----
64134	----	1-1/4" x 1"	1.58	1.67	10/40	0.80	65134	----
64136	----	1-1/2" x 3/4"	1.52	1.75	10/40	0.88	65136	----
64137	----	1-1/2" x 1"	1.65	1.80	10/40	1.07	65137	----
64138	----	1-1/2" x 1-1/4"	1.82	1.88	15/30	1.12	65138	----
		2" x 3/4"					65139	----
64140	----	2" x 1"	1.73	2.02	14/28	1.41	65140	----
64141	----	2" x 1-1/4"	1.90	2.10	10/20	1.53	65141	----
64142	----	2" x 1-1/2"	2.02	2.16	10/20	1.65	65142	----
64145	----	2-1/2" x 1-1/2"	2.16	2.51	6/12	2.97	65145	----
64146	----	2-1/2" x 2"	2.39	2.60	6/12	3.18	65146	----
64148	----	3" x 1-1/2"	2.28	2.83	6/18	4.54	65148	----

90° STREET ELBOWS

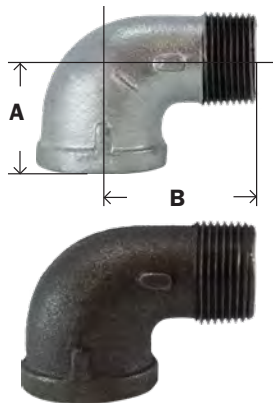

PART # GALVANIZED		SIZE	A	B	BOX/CASE	APPROX. WT. LBS.	PART # BLACK	
64160	----	1/8"	0.69	1.00	60/720	.06	65160	----
64161	----	1/4"	0.80	1.17	35/420	.10	65161	----
64162	----	3/8"	0.95	1.48	40/240	.15	65162	----
64163	----	1/2"	1.10	1.59	60/180	.22	65163	----
64164	----	3/4"	1.28	1.85	35/105	.39	65164	----
64165	----	1"	1.47	2.10	35/105	.60	65165	----
64166	----	1-1/4"	1.75	2.57	25/50	.95	65166	----
64167	----	1-1/2"	1.90	2.63	9/27	1.37	65167	----
64168	----	2"	2.21	3.19	8/16	2.25	65168	----
64169	----	2-1/2"	2.65	3.78	5/10	3.32	65169	----
64170	----	3"	3.02	4.42	4/8	5.27	65170	----
64171	----	4"	3.72	5.57	2/4	8.94	65171	----

WARNING: This product can expose you to chemicals, including Nickel, which are known to the State of California to cause cancer. For more information, visit www.P65Warnings.ca.gov

BLACK AND GALVANIZED IRON #150

NIPPLES AND FITTINGS

ELBOWS 45°

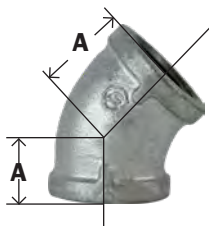

PART # GALVANIZED		SIZE	A	BOX/ CASE	APPROX. WT. LBS.	PART # BLACK	
64180	----	1/8"	0.63	50/600	.07	65180	----
64181	----	1/4"	0.73	30/360	.10	65181	----
64182	----	3/8"	0.80	75/300	.14	65182	----
64183	----	1/2"	0.88	50/200	.21	65183	----
64184	----	3/4"	0.98	40/120	.33	65184	----
64185	----	1"	1.12	20/60	.50	65185	----
64186	----	1-1/4"	1.29	20/40	.74	65186	----
64187	----	1-1/2"	1.43	10/30	1.01	65187	----
64188	----	2"	1.68	12/24	1.53	65188	----
64189	----	2-1/2"	1.95	9/18	2.78	65189	----
64190	----	3"	2.17	1/10	4.49	65190	----
64191	----	4"	2.61	2/4	7.44	65191	----
64192	----	6"	3.46	1/1	18.63	65192	----
		8"			26.40	65194	----

45° STREET ELBOWS

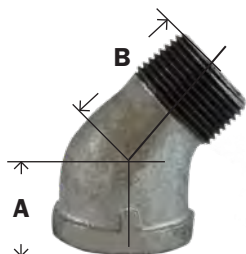

PART # GALVANIZED		SIZE	A	B	BOX/ CASE	APPROX. WT. LBS.	PART # BLACK	
64200	----	1/8"	0.63	0.83	70/840	.05	65200	----
64201	----	1/4"	0.73	0.94	40/480	.09	65201	----
64202	----	3/8"	0.80	1.03	100/400	.14	65202	----
64203	----	1/2"	0.86	1.30	75/225	.19	65203	----
64204	----	3/4"	0.96	1.48	40/120	.28	65204	----
64205	----	1"	1.10	1.69	25/75	.48	65205	----
64206	----	1-1/4"	1.26	1.87	10/40	.71	65206	----
64207	----	1-1/2"	1.40	2.05	10/30	1.02	65207	----
64208	----	2"	1.65	2.38	12/24	1.68	65208	----
64209	----	2-1/2"	1.95	2.72	6/12	2.69	65209	----
64210	----	3"	2.17	3.16	3/6	4.61	65210	----
64211	----	4"	2.61	3.90	2/4	7.74	65211	----

CROSSES

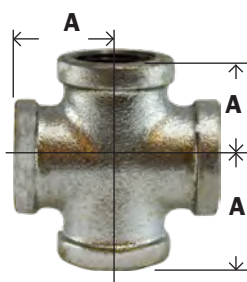

PART # GALVANIZED		SIZE	A	BOX/ CASE	APPROX. WT. LBS.	PART # BLACK	
64390	----	1/8"	0.65	50/600	.14	65390	----
64391	----	1/4"	0.80	60/240	.17	65391	----
64392	----	3/8"	0.95	50/150	.26	65392	----
64393	----	1/2"	1.12	30/90	.42	65393	----
64394	----	3/4"	1.31	20/60	.64	65394	----
64395	----	1"	1.50	15/30	.98	65395	----
64396	----	1-1/4"	1.75	10/20	1.45	65396	----
64397	----	1-1/2"	1.94	8/16	1.90	65397	----
64398	----	2"	2.25	5/10	2.96	65398	----
64399	----	2-1/2"	2.71	4/8	5.49	65399	----
64400	----	3"	3.06	2/4	7.71	65400	----
		4"		1/1	14.77	65401	----

WARNING: This product can expose you to chemicals, including Nickel, which are known to the State of California to cause cancer. For more information, visit www.P65Warnings.ca.gov

NIPPLES & FITTINGS

BLACK AND GALVANIZED IRON #150

NIPPLES AND FITTINGS

TEES

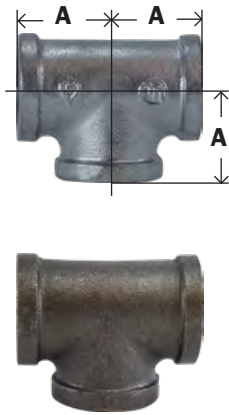

PART # GALVANIZED		SIZE	A	BOX/CASE	APPROX. WT. LBS.	PART # BLACK	
64250	----	1/8"	0.69	120/480	.11	65250	----
64251	----	1/4"	0.81	75/300	.15	65251	----
64252	----	3/8"	0.95	45/180	.22	65252	----
64253	----	1/2"	1.12	40/120	.36	65253	----
64254	----	3/4"	1.31	35/70	.48	65254	----
64255	----	1"	1.50	20/40	.83	65255	----
64256	----	1-1/4"	1.75	14/28	1.29	65256	----
64257	----	1-1/2"	1.94	12/24	1.66	65257	----
64258	----	2"	2.26	8/16	2.50	65258	----
64259	----	2-1/2"	2.70	4/8	4.45	65259	----
64260	----	3"	3.08	1/6	6.72	65260	----
64261	----	4"	3.79	1/2	11.31	65261	----
64262	----	6"	5.13	1/1	30.75	65262	----
		8"			37.85	65264	----

REDUCING TEES (SAME SIZE ON RUN, REDUCING ON BRANCH)

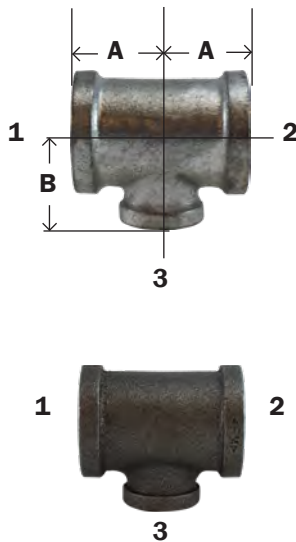

PART # GALVANIZED		SIZE (1&2) X 3	A	B	BOX/CASE	APPROX. WT. LBS.	PART # BLACK	
64273	----	3/8" x 1/4"	0.81	0.90	25/300	.18	65273	----
64276	----	1/2" x 1/4"	0.97	0.98	40/160	.24	65276	----
64279	----	1/2" x 3/8"	1.04	1.03	40/160	.35	65279	----
64282	----	3/4" x 1/4"	1.05	1.08	25/100	.43	65282	----
64283	----	3/4" x 3/8"	1.12	1.13	25/100	.39	65283	----
64286	----	3/4" x 1/2"	1.20	1.18	20/80	.49	65286	----
64268	----	1" x 1/4"	1.11	1.22	20/80	.51	65268	----
64269	----	1" x 3/8"	1.18	1.27	15/60	.55	65269	----
64291	----	1" x 1/2"	1.26	1.40	15/60	.63	65291	----
64298	----	1" x 3/4"	1.37	1.45	12/48	.71	65298	----
64301	----	1-1/4" x 1/2"	1.34	1.45	20/40	.91	65301	----
64303	----	1-1/4" x 3/4"	1.45	1.62	20/40	.99	65303	----
64306	----	1-1/4" x 1"	1.58	1.66	20/40	1.07	65306	----
64721	----	1-1/2" x 1/2"				1.12	65721	----
64316	----	1-1/2" x 3/4"	1.41	1.75	15/30	1.23	65316	----
64318	----	1-1/2" x 1"	1.65	1.88	10/30	1.33	65318	----
64322	----	1-1/2" x 1-1/4"	1.65	1.88	12/24	1.52	65322	----
64327	----	2" x 1/2"	1.49	1.88	10/20	1.64	65327	----
64328	----	2" x 3/4"	1.60	1.97	10/20	1.71	65328	----
64330	----	2" x 1"	1.73	2.02	10/20	1.88	65330	----
64334	----	2" x 1-1/4"	1.86	2.06	8/16	2.03	65334	----
64336	----	2" x 1-1/2"	1.98	2.12	8/16	2.22	65336	----
		2-1/2" x 1"				2.85	65342	----
64343	----	2-1/2" x 1-1/2"	2.16	2.51	5/10	2.97	65343	----
64729	----	3" x 1"	2.00	2.00	3/6	4.15		
		3" x 1-1/2"				5.19	65359	----
64351	----	3" x 2"	2.52	2.89	3/6	5.35	65351	----

BULLHEAD TEES



PART # GALVANIZED		SIZE (1&2) X 3	A	B	BOX/CASE	APPROX. WT. LBS.	PART # BLACK	
64280	----	1/2" x 3/4"	1.22	1.20	30/120	.4	65280	----
64733	----	1/2" x 1"	1.36	1.26	25/100	.50	65733	----
64289	----	3/4" x 1"	1.45	1.37	20/120	.60	65289	----
64299	----	1" x 1-1/4"	1.67	1.58	15/30	.96	65299	----
64300	----	1" x 1-1/2"	1.80	1.65	9/36	1.11	65300	----
64317	----	1-1/4" x 1-1/2"	1.88	1.82	12/24	1.07	65317	----
64319	----	1-1/2" x 2"	2.12	1.98	8/32	2.10	65-319	----
65335		2" x 1 1/4" x 2"						

WARNING: This product can expose you to chemicals, including Nickel, which are known to the State of California to cause cancer. For more information, visit www.P65Warnings.ca.gov

BLACK AND GALVANIZED IRON #150

NIPPLES AND FITTINGS

REDUCING TEES REDUCING ON RUN

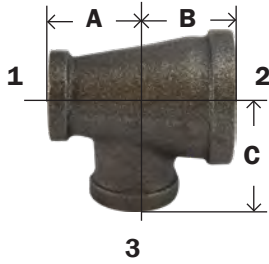

PART #	SIZE 1 X 2 X 3	A	B	C	BOX/ CASE	APPROX. WT. LBS.		PART # BLACK
64287	3/4" x 1/2" x 1/2"	1.18	1.18	1.20	25/100	0.39	----	65287
64288	3/4" x 1/2" x 3/4"	1.28	1.20	1.28	20/80	0.49	----	65288
	1" x 1/2" x 1/2"	1.31	1.22	1.31	20/80	0.51	----	65292
	1" x 1/2" x 3/4"	1.22	1.37	1.45	20/80	0.53	----	65293
64294	1" x 1/2" x 1"	1.40	1.50	1.50	15/60	0.54	----	65294
	1" x 3/4" x 1/2"	1.20	1.26	1.40	20/80	0.58	----	65295
64296	1" x 3/4" x 3/4"	1.34	1.28	1.42	15/60	0.63	----	65296
64297	1" x 3/4" x 1"	1.45	1.50	1.50	15/60	0.62	----	65297
	1-1/4" x 1/2" x 1/2"							65304
	1-1/4" x 1/2" x 1"							65311
	1-1/4" x 1/2" x 1 1/4"							65314
	1-1/4" x 3/4" x 3/4"	1.31	1.45	1.64	10/40	0.66	----	65347
	1-1/4" x 3/4" x 1"							65348
	1-1/4" x 3/4" x 1-1/4"	1.62	1.75	1.75	10/40	1.14	----	65305
64309	1-1/4" x 1" x 1"	1.55	1.47	1.63	20/40	1.00	----	65309
	1-1/4" x 3/4" x 1/2"	1.31	1.45	1.64	20/40	1.05	----	65346
	1-1/4" x 1" x 1/2"	1.26	1.34	1.53	20/40	1.10	----	65349
	1-1/4" x 1" x 3/4"						----	65350
	1-1/4" x 1" x 1-1/4"	1.30	1.36	1.44	15/30	1.21	----	65310
	1-1/2" x 3/4" x 1-1/2"							65281
64372	1-1/2" x 1" x 1"	1.50	1.65	1.78	15/30	1.28	----	65372
	1-1/2" x 1" x 1-1/2"							65323
	1-1/2" x 1-1/4" x 3/4"	1.43	1.52	1.25	15/30	1.30	----	65375
	1-1/2" x 1 1/4" x 1"							65325
	1-1/2" x 1-1/4" x 1-1/4"	1.75	1.82	1.88	15/30	1.35	----	65377
	2" x 3/4" x 2"						----	65267
	2" x 1" x 2"							65332
	2" x 1-1/4" x 1 1/4"							65302
	2" x 1-1/4" x 2"							65335
	2" x 1-1/2" x 1-1/4"	1.82	1.90	2.10	10/30	1.21	----	65312
	2" x 1-1/2" x 1-1/2"	1.94	2.02	2.16	10/30	1.79	----	65313

• SEE MIDLANDINDUSTRIES.COM FOR GALVANIZED REDUCING TEE & MORE BLACK SIZES

MALLEABLE SERVICE TEE (STREET TEE)

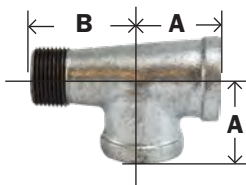

PART # GALVANIZED		SIZE	A	B	BOX/ CASE	APPROX. WT. LBS.	PART # BLACK	
64363	----	1/2"	1.12	1.62	40/12	0.31	65363	----
64364	----	3/4"	1.31	1.89	25/75	0.49	65364	----

SIDE OUTLET TEES

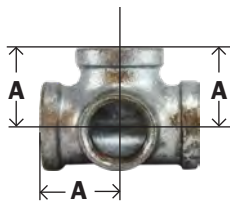

PART # GALVANIZED		SIZE	A	BOX/ CASE	APPROX. WT. LBS.	PART # BLACK	
64383	----	1/2"	1.12	25/100	.39	65383	----
64384	----	3/4"	1.31	15/60	.58	65384	----
64385	----	1"	1.50	20/40	.88	65385	----
64386	----	1-1/4"	1.75	12/24	1.32	65386	----
		1-1/2"	1.97	1/1	1.56	65387	----
		2"	2.29	1/1	1.81	65388	----

WARNING: This product can expose you to chemicals, including Nickel, which are known to the State of California to cause cancer.
 For more information, visit www.P65Warnings.ca.gov

NIPPLES & FITTINGS

BLACK AND GALVANIZED IRON #150

NIPPLES AND FITTINGS

COUPLINGS



PART # GALVANIZED		SIZE	A	BOX/ CASE	APPROX. WT. LBS.	PART # BLACK	
64410	----	1/8"	0.96	70/840	.07	65410	----
64411	----	1/4"	1.06	40/480	.09	65411	----
64412	----	3/8"	1.16	40/480	.13	65412	----
64413	----	1/2"	1.34	60/240	.19	65413	----
64414	----	3/4"	1.52	50/150	.28	65414	----
64415	----	1"	1.67	25/100	.45	65415	----
64416	----	1-1/4"	1.93	16/64	.66	65416	----
64417	----	1-1/2"	2.15	18/36	.84	65417	----
64418	----	2"	2.54	12/24	1.39	65418	----
64419	----	2-1/2"	2.88	8/16	2.42	65419	----
64420	----	3"	3.18	1/12	3.49	65420	----
64421	----	4"	3.69	3/6	5.81	65421	----
64422	----	6"	4.23	1/2	28.62	65422	----

REDUCING COUPLINGS



PART # GALVANIZED		SIZE	A	BOX/ CASE	APPROX. WT. LBS.	PART # BLACK	
64430	----	1/4" x 1/8"	1.00	50/600	.07	65430	----
64431	----	3/8" x 1/8"	1.13	35/420	.09	65431	----
64432	----	3/8" x 1/4"	1.13	30/360	.11	65432	----
64433	----	1/2" x 1/8"	1.25	75/300	.13	65433	----
64434	----	1/2" x 1/4"	1.25	75/300	.11	65434	----
64435	----	1/2" x 3/8"	1.25	60/240	.15	65435	----
64439	----	3/4" x 1/8"	1.44	60/240	.18	65439	----
64436	----	3/4" x 1/4"	1.44	45/18	.19	65436	----
64437	----	3/4" x 3/8"	1.44	45/18	.21	65437	----
64438	----	3/4" x 1/2"	1.44	60/180	.25	65438	----
64459	----	1" x 1/4"	1.69	45/135	.34	65459	----
64440	----	1" x 3/8"	1.69	30/120	.35	65440	----
64441	----	1" x 1/2"	1.69	30/120	.36	65441	----
64442	----	1" x 3/4"	1.69	25/100	.39	65442	----
64460	----	1-1/4" x 3/8"	2.06	25/75	.55	65460	----
64444	----	1-1/4" x 1/2"	2.06	25/75	.53	65444	----
64445	----	1-1/4" x 3/4"	2.06	25/75	.57	65445	----
64446	----	1-1/4" x 1"	2.06	15/60	.61	65446	----
64443	----	1-1/2" x 3/8"	2.31	20/60	.71	65443	----
64447	----	1-1/2" x 1/2"	2.31	20/60	.69	65447	----
64448	----	1-1/2" x 3/4"	2.31	15/60	.71	65448	----
64449	----	1-1/2" x 1"	2.31	25/50	.78	65449	----
64450	----	1-1/2" x 1-1/4"	2.31	12/48	.87	65450	----
64458	----	2" x 1/2"	2.81	12/36	1.14	65458	----
64451	----	2" x 3/4"	2.81	12/36	1.14	65451	----
64452	----	2" x 1"	2.81	12/36	1.21	65452	----
64453	----	2" x 1-1/4"	2.81	9/27	1.19	65453	----
64454	----	2" x 1-1/2"	2.81	9/27	1.38	65454	----
		2 1/2" x 1"				65455	
		2 1/2" x 1 1/4"				65429	
64461	----	2-1/2" x 1-1/2"	3.25	20/40	2.07	65461	----
64462	----	2-1/2" x 2"	3.25	7/14	2.23	65462	----
		3" x 1"				65466	
		3" x 1-1/4"				65467	
64486	----	3" x 1-1/2"	3.69	6/12	3.23	65486	----
64456	----	3" x 2"	3.69	6/12	3.30	65456	----
64463	----	3" x 2-1/2"	3.69	5/10	3.55	65463	----
		4" x 1 1/2"				65468	
64464	----	4" x 2"	4.38	3/6	5.55	65464	----
64465	----	4" x 2-1/2"	4.38	3/6	5.90	65465	----
64457	----	4" x 3"	4.38	3/6	6.05	65457	----
		6" x 4"	4.24	1/2	10.86	65491	----

SEE MIDLANDINDUSTRIES.COM FOR MORE SIZES

WARNING: This product can expose you to chemicals, including Nickel, which are known to the State of California to cause cancer. For more information, visit www.P65Warnings.ca.gov

BLACK AND GALVANIZED IRON #150

NIPPLES AND FITTINGS

HEX BUSHING



SEE MIDLANDINDUSTRIES.COM
FOR MORE SIZES



* INSIDE HEX

NOTE: ADD DT TO THE
PART# FOR A DOUBLE-
TAPPED BUSHING

PART #		SIZE	A	HEX	BOX/ CASE	APPROX. WT. LBS.	PART #	
GALVANIZED		M X F					BLACK	
64500	----	*1/4" x 1/8"	0.79	0.67	1/25	.03	65500	----
64501	----	*3/8" x 1/8"	0.79	0.75	1/25	.06	65501	----
64502	----	*3/8" x 1/4"	0.79	0.75	1/25	.05	65502	----
64503	----	1/2" x 1/8"	0.84	1.03	150/600	.09	65503	----
64504	----	1/2" x 1/4"				.08	65504	----
64505	----	1/2" x 3/8"	0.75	1.03	150/600	.07	65505	----
64506	----	3/4" x 1/8"	0.85	1.15	75/300	.14	65506	----
64507	----	3/4" x 1/4"	0.85	1.15	75/300	.13	65507	----
64508	----	3/4" x 3/8"	0.85	1.15	75/300	.12	65508	----
64509	----	3/4" x 1/2"	0.93	1.15	75/300	.10	65509	----
		1" x 1/8"					65557	
64510*	----	1" x 1/4"	1.13	1.12	50/200	.20	65510*	----
64511*	----	1" x 3/8"	1.13	1.12	50/200	.18	65511*	----
64512	----	1" x 1/2"	1.10	1.42	50/200	.21	65512	----
64513	----	1" x 3/4"	1.10	1.42	50/200	.17	65513	----
64514*	----	1-1/4" x 1/4"	1.24	1.12	30/120	.29	65514*	----
64515*	----	1-1/4" x 3/8"	1.24	1.12	30/120	.29	65515*	----
64516*	----	1-1/4" x 1/2"	1.24	1.24	30/120	.31	65516*	----
64517	----	1-1/4" x 3/4"	1.08	1.76	30/120	.35	65517	----
64518	----	1-1/4" x 1"	1.08	1.76	30/120	.29	65518	----
64519*	----	1-1/2" x 1/4"	1.30	1.12	25/75	.40	65519*	----
64520*	----	1-1/2" x 3/8"	1.30	1.12	25/75	.38	65520*	----
64521*	----	1-1/2" x 1/2"	1.30	1.34	25/75	.38	65521*	----
64522*	----	1-1/2" x 3/4"	1.30	1.44	25/75	.40	65522*	----
64523	----	1-1/2" x 1"	1.23	2.00	25/75	.45	65523	----
64524	----	1-1/2" x 1-1/4"	1.23	2.00	25/75	.34	65524	----
64526	----	2" x 1/4"	1.29	1.12	20/60	.57	65526	----
64525*	----	2" x 3/8"	1.28	1.12	20/60	.57	65525*	----
64527*	----	2" x 1/2"	1.39	1.34	20/60	.57	65527*	----
64528*	----	2" x 3/4"	1.39	1.63	20/60	.63	65528*	----
64529*	----	2" x 1"	1.39	1.77	20/60	.66	65529*	----
64530	----	2" x 1-1/4"	1.50	2.48	20/60	.74	65530	----
64531	----	2" x 1-1/2"	1.50	2.48	20/60	.61	65531	----
64546*	----	2-1/2" x 1/2"	1.51	1.34	15/30	.97	65546*	----
64547*	----	2-1/2" x 3/4"	1.51	1.63	15/30	.91	65547*	----
64532*	----	2-1/2" x 1"	1.51	1.95	15/30	.97	65532*	----
64533*	----	2-1/2" x 1-1/4"	1.51	2.39	15/30	1.03	65533*	----
64534	----	2-1/2" x 1-1/2"	1.51	2.98	15/30	1.16	65534	----
64535	----	2-1/2" x 2"	1.54	2.98	15/30	1.01	65535	----
64550	----	3" x 1"	1.61	1.95	12/24	1.41	65550	----
64549*	----	3" x 1-1/4"	1.61	2.39	12/24	1.42	65549*	----
64537*	----	3" x 1-1/2"	1.61	2.68	12/24	1.51	65537*	----
64538	----	3" x 2"	1.61	3.86	12/24	1.71	65538	----
64539	----	3" x 2-1/2"	1.61	3.86	12/24	1.68	65539	----
		3-1/2" x 3"	1.86	4.20	5/10	2.17	65555	----
64551	----	4" x 3/4"	2.15	4.90	5/10	3.88	65551	----
64553*	----	4" x 1"	2.00	4.75	5/10	3.79	65553*	----
64552	----	4" x 1-1/4"	1.82	2.39	5/10	2.39	65552	----
64540	----	4" x 1-1/2"	1.82	2.68	5/10	2.39	65540	----
64541*	----	4" x 2"	1.82	3.31	5/10	2.52	65541*	----
64542*	----	4" x 2-1/2"	2.06	3.87	5/10	2.87	65542*	----
64543	----	4" x 3"	2.17	4.96	5/10	2.95	65543	----
		5" x 4"	2.16	5.34	2/4	6.80	65544	----
64544		6" x 2"					65558	
64549		6" x 3"					65559	
64545*	----	6" x 4"	2.33	5.79	2/4	7.11	65545*	----
		6" x 5"			2/4		65560	

WARNING: This product can expose you to chemicals, including Nickel, which are known to the State of California to cause cancer.
 For more information, visit www.P65Warnings.ca.gov

NIPPLES & FITTINGS

BLACK AND GALVANIZED IRON #150

NIPPLES AND FITTINGS

UNIONS

• Brass Seat



PART # GALVANIZED		SIZE	A	BOX/ CASE	APPROX. WT. LBS.	PART # BLACK	
64600	----	1/8"	1.26	60/240	.17	65600	----
64601	----	1/4"	1.44	20/240	.25	65601	----
64602	----	3/8"	1.61	40/160	.37	65602	----
64603	----	1/2"	1.72	50/100	.52	65603	----
64604	----	3/4"	1.94	35/70	.78	65604	----
64605	----	1"	2.06	20/40	1.18	65605	----
64606	----	1-1/4"	2.26	15/30	1.64	65606	----
64607	----	1-1/2"	2.41	10/20	2.08	65607	----
64608	----	2"	2.75	6/12	3.24	65608	----
64609	----	2-1/2"	3.22	4/8	5.31	65609	----
64610	----	3"	3.50	4/8	6.94	65610	----
64611	----	4"	3.85	2/4	12.02	65611	----

SQUARE HEAD PLUGS

• Cored

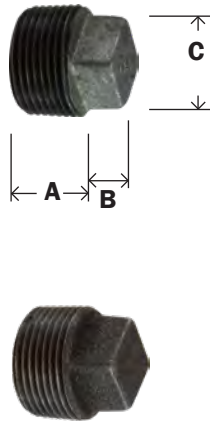

PART # GALVANIZED		SIZE	A	B	C	BOX/ CASE	APPROX. WT. LBS.	PART # BLACK	
		*1/8"	0.41	0.23	0.30	1/25	.02	65650	----
64651	----	*1/4"	0.48	0.28	0.38	1/25	.03	65651	----
64652	----	*3/8"	0.53	0.31	0.43	1/25	.04	65652	----
64653	----	1/2"	0.58	0.38	0.56	50/600	.08	65653	----
64654	----	3/4"	0.65	0.44	0.63	30/360	.13	65654	----
64655	----	1"	0.75	0.50	0.82	20/240	.22	65655	----
64656	----	1-1/4"	0.82	0.56	0.94	40/120	.33	65656	----
64657	----	1-1/2"	0.85	0.62	1.13	30/90	.41	65657	----
64658	----	2"	0.91	0.68	1.31	20/60	.68	65658	----
64659	----	2-1/2"	1.26	0.74	1.50	16/64	.89	65659	----
64660	----	3"	1.16	0.80	1.69	16/32	1.68	65660	----
64661	----	4"	1.22	1.00	2.28	6/12	3.02	65661	----
		6"	1.85	1.13	5.97	5/10	11.41	65662	----
		8"				1/1		65664	----

CAPS



PART # GALVANIZED		SIZE	A	BOX/ CASE	APPROX. WT. LBS.	PART # BLACK	
64470	----	1/8"	0.55	1/25	.03	65470	----
64471	----	1/4"	0.62	80/960	.07	65471	----
64472	----	3/8"	0.74	60/720	.08	65472	----
64473	----	1/2"	0.87	75/300	.13	65473	----
64474	----	3/4"	0.97	40/160	.18	65474	----
64475	----	1"	1.16	25/100	.30	65475	----
64476	----	1-1/4"	1.28	20/80	.47	65476	----
64477	----	1-1/2"	1.33	18/54	.66	65477	----
64478	----	2"	1.45	12/36	.99	65478	----
64479	----	2-1/2"	1.70	20/40	1.58	65479	----
64480	----	3"	1.80	12/24	2.51	65480	----
64481	----	4"	2.08	6/12	4.09	65481	----
64482	----	6"	2.55	2/4	5.18	65482	----

* Use steel fittings for smaller sizes. See Steel Fittings for Galvanized and Black Steel Fittings.

WARNING: This product can expose you to chemicals, including Nickel, which are known to the State of California to cause cancer. For more information, visit www.P65Warnings.ca.gov

BLACK AND GALVANIZED IRON #150

NIPPLES AND FITTINGS

LATERAL Ys

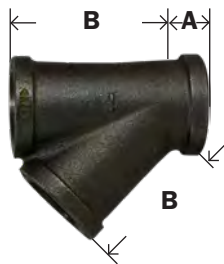

PART #	SIZE	A	B	CASE	WEIGHT		PART #
64963	1/2	2.32	1.71	120	.35	----	65963
64964	3/4	2.77	2.05	60	.58	----	65964
	1	3.28	2.42	40	.97	----	65965
	1-1/4	3.94	2.92	24	1.44	----	65966
	1-1/2	4.38	3.28	16	1.93	----	65967
64968	2	5.41	3.98	8	3.12	----	65968
	2-1/2	6.25	4.73	4	5.61	----	65969
	3	7.26	5.55	2	8.36	----	65970
	4	8.98	6.97	2	14.88	----	65971

LOCKNUTS

*Straight Thread

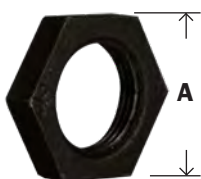

PART #		SIZE	A	THICK- NESS	BOX/ CASE	WEIGHT	PART #	
GALV			HEX				BLACK	
64703	----	1/2		0.31	150/600	0.08	65703	----
64704	----	3/4		0.34	90/360	0.13	65704	----
64705	----	1		0.38	60/240	0.19	65705	----
64706	----	1-1/4		0.42	45/180	0.27	65706	----
64707	----	1-1/2		0.47	45/135	0.47	65707	----
64708	----	2		0.53	25/75	0.56	65708	----

RIGHT & LEFT COUPLINGS

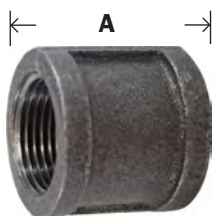

PART #		SIZE	A	CASE	WEIGHT	PART #	
GALV						BLACK	
64573	----	1/2	1.34	240	0.19	65573	----
64574	----	3/4	1.52	150	0.28	65574	----
64575	----	1	1.67	100	0.45	65575	----
64576	----	1-1/4	1.93	64	0.66	65576	----
64577	----	1-1/2	2.15	36	0.84	65577	----
64578	----	2	2.53	24	1.39	65578	----

SIDE OUTLET ELBOW

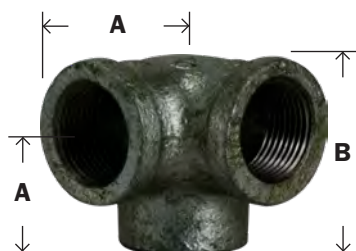

PART #		SIZE	A	B	CASE	PART #	
GALV						BLACK	
64583	----	1/2	1.10		135	65583	----
64584	----	3/4	1.30		80	65584	----
64585	----	1	1.50		40	65585	----
64586	----	1-1/4	1.77		30	65586	----
64587	----	1-1/2	1.97		24	65587	----
64588	----	2	2.29		10	65588	----



HELP US HELP YOU! GO ONLINE TO UPDATE YOUR CUSTOMER PROFILE SO THAT WE CAN UPDATE ALL THE APPROPRIATE DEPARTMENTS AND PERSONNEL AT YOUR COMPANY ON NEW CATALOGS, PRICING UPDATES, NEW MARKETING TOOLS, AND OTHER IMPORTANT INFORMATION. THANK YOU!

WARNING: This product can expose you to chemicals, including Nickel, which are known to the State of California to cause cancer. For more information, visit www.P65Warnings.ca.gov

NIPPLES & FITTINGS

BLACK AND GALVANIZED IRON #150

NIPPLES AND FITTINGS

FLOOR FLANGES

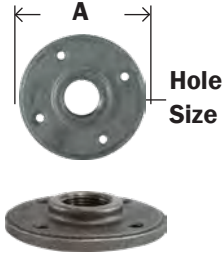

PART #	GALVANIZED	SIZE	A	THICKNESS	HOLE SIZE	BOX/CASE	APPROX. WT. LBS.	PART # BLACK
		1/4"						65691
		3/8"						65690
64692	----	1/2"	3.50	0.50	0.25	25/100	.63	65692
64693	----	3/4"	3.50	0.63	0.25	15/45	.73	65693
64694	----	1"	4.00	0.69	0.25	15/45	1.02	65694
64695	----	1-1/4"	4.00	0.75	0.25	15/30	1.00	65695
64696	----	1-1/2"	4.50	0.87	0.31	8/24	1.37	65696

EXTENSION FIP X MIP



PART #	SIZE	APPROX. WT. LBS.	BOX/CASE
65621	1/2"	0.12	75 / 300
65622	3/4"	0.23	40 / 160

MUSHROOM VENT CAP



PART #	SIZE
21174	3/4"
21175	1"
21176	1-1/2"
21177	1-1/2"
21178	2"
21179	3"
21180	4"

More sizes available - see website

Cast Iron Galvanized Threaded Cap. 30 Mesh screen. Protects against driving rain, snow, sleet and insects.

DOUBLE TAPPED BUSHINGS



PART #	SIZE
65518DT	1-1/4" x 1"
65522DT	1-1/2" x 3/4"
65523DT	1-1/2" x 1"
65527DT	2" x 1/2"
65528DT	2" x 3/4"
65529DT	2" x 1"
65530DT	2" x 1/4"
65531DT	2" x 1-1/2"
65541DT	4" x 2"

SEE MIDLANDINDUSTRIES.COM FOR:



DUPLEX TANK BUSHINGS



WASTE NUT

WARNING: This product can expose you to chemicals, including Nickel, which are known to the State of California to cause cancer. For more information, visit www.P65Warnings.ca.gov

STEEL FITTINGS

NIPPLES AND FITTINGS

STEEL FITTINGS

This will certify that the material was manufactured in accordance with ASME B16.14 - 1991 Standards. All Threads are Dryseal (NPTF) - 3/4 inch taper per foot and are made of Carbon Steel 12L14. Pressure rating: 150/300 PSI

- Clear Zinc plating specifications ASTM B633-07
- Federal Specification QQ-Z-325 (Zinc Plate)
- Type III with supplemental clear Trivalent chromate
- .00015" Zinc (Minimum)
- ROHS Compliant
- Lead Free

HEX BUSHINGS



PART # ZINC		SIZE M X F	A	HEX	APPROX. WT. LBS.	PART # BLACK	
66500	----	1/4" x 1/8"	0.63	0.62	0.02	67500	----
66501	----	3/8" x 1/8"	0.66	0.68	0.04	67501	----
66502	----	3/8" x 1/4"	0.66	0.68	0.02	67502	----
66503	----	1/2" x 1/8"	0.80	0.87	0.10	67503	----
66504	----	1/2" x 1/4"	0.80	0.87	0.08	67504	----
66505	----	1/2" x 3/8"	0.80	0.87	0.06	67505	----
66506	----	3/4" x 1/8"	0.94	1.06	0.18	67506	----
66507	----	3/4" x 1/4"	0.94	1.06	0.14	67507	----
66508	----	3/4" x 3/8"	0.94	1.06	0.14	67508	----
66509	----	3/4" x 1/2"	0.94	1.06	0.10	67509	----
66510	----	1" x 1/4"	1.00	1.31	0.16	67510	----
66511	----	1" x 3/8"	1.00	1.31	0.26	67511	----
66512	----	1" x 1/2"	1.00	1.31	0.22	67512	----
66513	----	1" x 3/4"	1.00	1.31	0.14	67513	----

FACE BUSHING

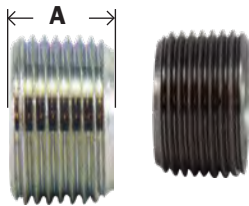

PART # ZINC		SIZE M X F	A	APPROX. WT. LBS.	PART # BLACK	
	----	1/4" x 1/8"	0.44	0.01	67700	----
	----	3/8" x 1/4"	0.48	0.02	67702	----
	----	1/2" x 1/4"	0.56	0.04	67704	----
66705	----	1/2" x 3/8"	0.56	0.04	67705	----
	----	3/4" x 3/8"	0.62	0.10	67708	----
66709	----	3/4" x 1/2"	0.62	0.10	67709	----
	----	1" x 3/4"	0.75	0.16	67713	----

CAPS

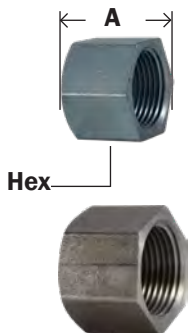

PART # ZINC		SIZE NPTF	A	HEX	APPROX. WT. LBS.	PART # BLACK	
66470	----	1/8"	0.53	0.56	0.02	67470	----
66471	----	1/4"	0.63	0.62	0.04	67471	----
66472	----	3/8"	0.69	0.81	0.06	67472	----
66473	----	1/2"	0.87	1.00	0.12	67473	----
66474	----	3/4"	0.97	1.18	0.16	67474	----
66475	----	1"	1.16	1.50	0.30	67475	----
	----	1-1/4"	1.28	2.00	0.68	67476	----
	----	1-1/2"	1.35	2.25	0.83	67477	----

WARNING: This product can expose you to chemicals, including Nickel, which are known to the State of California to cause cancer. For more information, visit www.P65Warnings.ca.gov

NIPPLES & FITTINGS

STEEL FITTINGS

NIPPLES AND FITTINGS

This will certify that the plugs are dimensional per SAE J531 MAY 95 Standards. All threads are Dryseal (NPTF) - 3/4" Taper per foot and are made of SAE J403 Low Carbon Steel 1010 Cold headed.

SQUARE HEAD PLUGS

• Solid

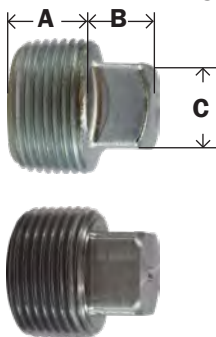

PART #		SIZE	A	B	C	APPROX. WT. LBS.	PART #	
ZINC		NPTF					BLACK	
66670	----	1/8"	0.33	0.24	0.28	0.01	67670	----
66671	----	1/4"	0.45	0.28	0.37	0.02	67671	----
66672	----	3/8"	0.50	0.31	0.43	0.04	67672	----
66653	----	1/2"	0.59	0.38	0.55	0.12	67653	----
66654	----	3/4"	0.63	0.44	0.62	0.18	67654	----
66655	----	1"	0.75	0.5	0.81	0.34	67655	----
66656	----	1-1/4"	0.80	0.56	0.93	0.62	67656	----
66657	----	1-1/2"	0.83	0.62	1.12	0.82	67657	----
66658	----	2"	0.88	0.68	1.31	1.36	67658	----

HEX HEAD PLUGS

• Solid



PART #		SIZE	A	HEX	APPROX. WT. LBS.	PART #	
ZINC		NPTF				BLACK	
66770	----	1/8"	0.55	0.43	0.01	67770	----
66771	----	1/4"	0.74	0.56	0.04	67771	----
66772	----	3/8"	0.67	0.68	0.06	67772	----
66773	----	1/2"	0.80	0.70	0.12	67773	----
66774	----	3/4"	0.94	1.06	0.18	67774	----
66775	----	1"	1.00	1.31	0.22	67775	----
66776	----	1-1/4"	1.17	1.75	0.7	67776	----
66777	----	1-1/2"	1.51	2.00	1.2	67777	----
66778	----	2"	1.65	2.50	2.06	67778	----

COUNTERSUNK PLUG - Square Socket



PART #		SIZE	A	SOCKET SIZE	APPROX. WT. LBS.	PART #	
ZINC		NPTF				BLACK	
66630	----	1/8"	0.29	0.19	0.01	67630	----
66631	----	1/4"	0.45	0.25	0.02	67631	----
66632	----	3/8"	0.45	0.31	0.04	67632	----
66633	----	1/2"	0.59	0.38	0.08	67633	----
66634	----	3/4"	0.60	0.50	0.12	67634	----
66635	----	1"	0.75	0.50	0.16	67635	----
66636	----	1-1/4"	0.80	0.75	0.32	67636	----
66637	----	1-1/2"	0.83	0.75	0.45	67637	----
66638	----	2"	0.88	0.875	2.06	67638	----

COUNTERSUNK PLUG - Hex Socket



PART #		SIZE	A	SOCKET SIZE	APPROX. WT. LBS.	PART #	
ZINC		NPTF				BLACK	
66760	----	1/16"	0.29	0.15	0.01	67760	----
66761	----	1/8"	0.29	0.18	0.01	67761	----
66762	----	1/4"	0.44	0.25	0.02	67762	----
66763	----	3/8"	0.44	0.31	0.04	67763	----
66764	----	1/2"	0.59	0.37	0.08	67764	----
66765	----	3/4"	0.60	0.56	0.14	67765	----
66766	----	1"	0.75	0.625	0.22	67766	----
66767	----	1-1/4"	0.80	0.75	0.37	67767	----
66768	----	1-1/2"	0.83	1.0	0.45	67768	----
66769	----	2"	0.88	1.0	0.86	67769	----

• Slotted and Flush plugs available upon request

WARNING: This product can expose you to chemicals, including Nickel, which are known to the State of California to cause cancer. For more information, visit www.P65Warnings.ca.gov

BLACK EXTRA HEAVY 300# IRON

NIPPLES AND FITTINGS

300# MALLEABLE

90° ELBOW



PART #	SIZE	
69101	1/4"	----
69102	3/8"	----
69103	1/2"	----
69104	3/4"	----
69105	1"	----
69106	1-1/4"	----
69107	1-1/2"	----
69108	2"	----

45° ELBOW



PART #	SIZE	
69181	1/4"	----
69182	3/8"	----
69183	1/2"	----
69184	3/4"	----
69185	1"	----
69186	1-1/4"	----
69187	1-1/2"	----
69188	2"	----

90° STREET ELBOW



PART #	SIZE	
69161	1/4"	----
69162	3/8"	----
69163	1/2"	----
69164	3/4"	----
69165	1"	----
69166	1-1/4"	----
69167	1-1/2"	----
69168	2"	----

TEE



PART #	SIZE	
69252	3/8"	----
69253	1/2"	----
69254	3/4"	----
69255	1"	----
69256	1-1/4"	----
69257	1-1/2"	----
69258	2"	----

COUPLING



PART #	SIZE	
69411	1/4"	----
69412	3/8"	----
69413	1/2"	----
69414	3/4"	----
69415	1"	----
69416	1-1/4"	----
69417	1-1/2"	----
69418	2"	----

SEE MIDLANDINDUSTRIES.COM FOR MORE SIZES AND GALVANIZED



SEE WEBSITE TO DOWNLOAD YOUR MOST UPDATED PRICING

WARNING: This product can expose you to chemicals, including Nickel, which are known to the State of California to cause cancer. For more information, visit www.P65Warnings.ca.gov

NIPPLES & FITTINGS

BLACK EXTRA 300# IRON

NIPPLES AND FITTINGS

REDUCING COUPLING



PART #	SIZE	
69432	3/8 x 1/4"	----
69434	1/2 x 1/4"	----
69435	1/2 x 3/8"	----
69438	3/4 x 1/2"	----
69441	1 x 1/2"	----
69442	1 x 3/4"	----

CAP



PART #	SIZE	
69471	1/4"	----
69472	3/8"	----
69473	1/2"	----
69474	3/4"	----
69475	1"	----
69476	1-1/4"	----
69477	1-1/2"	----
69478	2"	----

UNION

• Brass Seat



PART #	SIZE	
69600	1/8"	----
69601	1/4"	----
69602	3/8"	----
69603	1/2"	----
69604	3/4"	----
69605	1"	----
69606	1-1/4"	----
69607	1-1/2"	----
69608	2"	----

STEEL MAGNETIC PLUGS

Steel Magnetic Drain Plugs - NPT Threaded

Magnetic Drain Plugs are similar to standard pipe or straight thread drain plugs with one important difference - a permanent magnet is fastened to the plug body. This magnet attracts and holds abrasive, ferrous metal particles preventing their circulation through the lubrication or hydraulic system.

These abrasive, ferrous metal particles appear in lubricating or hydraulic systems as a result of the following conditions:

- The constant flaking effect of normal wear of moving parts.
- Particles not removed by flushing operations after boring or machining.
- Chipping due to sub-surface casting flaws.
- Minute component breakdown caused by stress usage.

Magnetic Drain Plugs prevent excessive wear to the system's components.

Magnetic Plugs are used by numerous manufacturers of gear boxes, transmissions, engines, and hydraulic systems for the automotive, aircraft, agricultural and machinery industries.

Typical applications include:

- Outboard Engines
- Earthmoving Equipment
- Combines
- Balers
- Crawler Tractors
- Lift Trucks
- Mining Equipment
- Military Vehicles
- Turbine Engines
- Truck Axles
- Heavy-Duty Transmissions

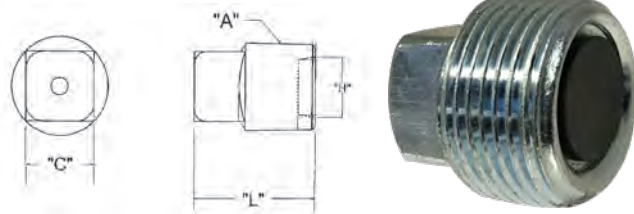

PART	SIZE "A"	HEAD WIDTH "C"	RECESS DIA. "H"	O/L LENGTH "L"	
28996	3/8 - 18	.428 - .440	.435 - .445	.805 - .860	----
28997	1/2 - 14	.553 - 565	.560 - .570	.970 - 1.04	----
28998	3/4 - 14	.615 - .627	.725 - .735	1.120 - 1.170	----
28999	1-11 1/2	.803 - 815	.895 - .905	1.25 - 1.33	----

WARNING: This product can expose you to chemicals, including Nickel, which are known to the State of California to cause cancer. For more information, visit www.P65Warnings.ca.gov



BULL PLUGS AND SWAGS

NIPPLES AND FITTINGS

BULL PLUGS AND SWAGES

STANDARD BULL PLUG

- Sch 40 150#
- Zinc plated



PART #	DESCRIPTION	
91008	2"	----
	2" w/ 1/2" TAP	----
	2-1/2"	----
	3"	----
	4"	----

XH BULL PLUG

- Made from sch. 80 pipe.
- Zinc plated
- Hollow



PART #	DESCRIPTION	
	1/4"	----
90002	3/8"	----
90003	1/2"	----
90004	3/4"	----
90005	1"	----
	1-1/4"	----
	1-1/2"	----
90008	2"	----
93001*	2"	----
90213	2" w/ 1/4" TAP	----
90212	2" w/ 1/2" TAP	----
93212*	2"XXH w/1/2" TAP	----
	2-1/2"	----
	3"	----
	3" w/ 1/2" TAP	----
90011	4"	----

* XXH

STANDARD SCH. 40 SWAGE

MIP X MIP

- Zinc plated



PART #	DESCRIPTION	
93113	1-1/4" x 1"	----
93121	2" x 1"	----
93122	2" x 1-1/4"	----
93123	2" x 1-1/2"	----
	2-1/2" x 2"	----
	3" x 1"	----
93127	3" x 1-1/2"	----
93128	3" x 2"	----
	3" x 2-1/2"	----
93130	4" x 2"	----
93131	4" x 3"	----
93139	6" x 3"	----

Pressure Ratings: Due to the wide variation in service conditions, temperature, vibrations, etc...Midland Industries can make no recommendations as to allowable working pressure of swage nipples and bull plugs. There are a number of working pressure formulas from which the end user may choose to determine the required wall thickness of the piping system. It is our responsibility only to furnish a fitting with end dimensions equal to those of the pipe size and schedule ordered.

WARNING: This product can expose you to chemicals, including Nickel, which are known to the State of California to cause cancer. For more information, visit www.P65Warnings.ca.gov

SWAGES

NIPPLES AND FITTINGS

SCH 80 XH SWAGES

MIP X MIP



* Hex Style



PART #	DESCRIPTION	
	1/4" x 1/8"	----
	1/2" x 1/4"	----
90103*	1/2" x 3/8"	----
90104*	3/8" x 1/4"	----
90105*	3/4" x 1/4"	----
90106*	3/4" x 3/8"	----
90107*	3/4" x 1/2"	----
	1" x 1/4"	----
	1" x 3/8"	----
90110*	1" x 1/2"	----
90111*	1" x 3/4"	----
90140	1-1/4" x 3/4"	----
90141	1-1/4" x 1"	----
90114	1-1/2" x 1/2"	----
90115	1-1/2" x 3/4"	----
90116	1-1/2" x 1"	----
90117	1-1/2" x 1-1/4"	----
	2" x 1/4"	----
90119	2" x 1/2"	----
90120	2" x 3/4"	----
90121	2" x 1"	----
90122	2" x 1-1/4"	----
90123	2" x 1-1/2"	----
	2-1/2" x 2"	----
	3" x 1"	----
90126	3" x 1-1/4"	----
90127	3" x 1-1/2"	----
90128	3" x 2"	----
	3" x 2-1/2"	----
	4" x 1"	----
90130	4" x 2"	----
90131	4" x 3"	----
90132	6" x 4"	----
	6" x 2"	----
	6" x 3"	----

XXH SWAGE



PART #	DESCRIPTION	
	1/2" x 1/4"	----
	3/4" x 1/2"	----
	1" x 1/4"	----
	1" x 3/8"	----
92110*	1" x 1/2"	----
	1" x 3/4"	----
	1-1/2" x 1/2"	----
	1-1/2" x 3/4"	----
92116	1-1/2" x 1"	----
	2" x 1/2"	----
	2" x 3/4"	----
92121	2" x 1"	----
	2" x 1-1/4"	----
	2" x 1-1/2"	----
92128	3" x 2"	----

WARNING: This product can expose you to chemicals, including Nickel, which are known to the State of California to cause cancer. For more information, visit www.P65Warnings.ca.gov



FORGED STEEL FLANGES

NIPPLES AND FITTINGS

ASTMA105
ASME SA105
ANSI B16.5

CARBON STEEL FLANGES

• A105 Forged Steel • CLASS 150
(1-1/2 thru 6" available in #316 Stainless Steel add SS to part#)

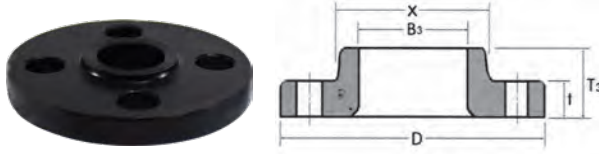

SLIP-ON 1/16" RAISED FACE CARBON STEEL FLANGE

PART #	SIZE	
	1/2"	----
	3/4"	----
	1"	----
	1-1/4"	----
107024	1-1/2"	----
107025	2"	----
107026	2-1/2"	----
107027	3"	----
107029	4"	----
107031	6"	----
107032	8"	----
	10"	----
	12"	----

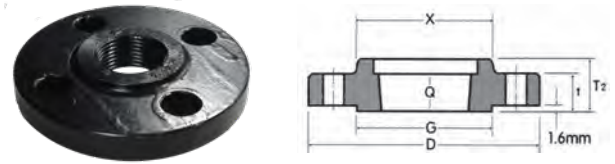

THREADED 1/16" RAISED FACE CARBON STEEL FLANGE

PART #	SIZE	
107060	1/2"	----
107061	3/4"	----
107062	1"	----
107063	1-1/4"	----
107064	1-1/2"	----
107065	2"	----
107066	2-1/2"	----
107067	3"	----
107069	4"	----
107071	6"	----
107072	8"	----
107073	10"	----
	12"	----

Nominal Pipe Size	Depth of Socket in. Y	Bolt Circle Diameter	Number of Holes	Diameter of Holes	Diameter of Bolts (inch)	Machine Bolt Length			Welding Neck LBS	Slip-on and Threaded LBS	Blind LBS
						Stud Bolt Length					
						Raised Face	Raised Face	Ring Joint			
1/2	.382	2.382	4	.618	1/2	2.00	2.252	-	1.146	1.036	1.036
3/4	.441	2.752	4	.618	1/2	2.00	2.50	-	2.028	1.653	1.389
1	.500	3.118	4	.618	1/2	2.252	2.50	3.00	2.425	1.893	2.094
1-1/4	.559	3.50	4	.618	1/2	2.252	2.752	3.252	3.086	3.086	3.086
1-1/2	.618	3.882	4	.618	1/2	2.50	2.752	3.252	3.99	3.109	3.571
2	.689	4.752	4	.752	5/8	2.752	3.252	3.752	6.173	4.982	5.82
2-1/2	.752	5.5	4	.752	5/8	3.00	3.50	4.00	9.436	7.562	8.951
3	.811	6.0	4	.752	5/8	3.00	3.50	4.00	11.42	8.818	11.023
4	.941	7.50	8	.752	5/8	3.00	3.50	4.00	16.138	12.677	16.535
6	1.059	9.50	8	.882	3/4	3.252	4.00	4.50	24.824	17.196	26.455
8	1.252	11.752	8	.882	3/4	3.50	4.252	4.752	39.683	28.66	44.092
10	1.311	14.252	12	1.00	7/8	4.00	4.50	5.00	55.116	37.699	66.139
12	1.559	17	12	1.00	7/8	4.00	4.752	5.252	85.936	61.024	97.003

WARNING: This product can expose you to chemicals, including Nickel, which are known to the State of California to cause cancer. For more information, visit www.P65Warnings.ca.gov

FORGED STEEL FLANGES

NIPPLES AND FITTINGS

ASTMA105
ASME SA105
ANSI B16.5

• A105 Forged Steel

• CLASS 150

(1-1/2 thru 6" available in #316 Stainless Steel add SS to part#)

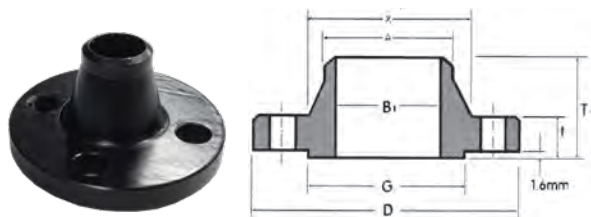

WELD NECK CARBON STEEL FLANGE

Part #	Size	
	1/2"	----
	3/4"	----
	1"	----
	1-1/4"	----
107004	1-1/2"	----
107005	2"	----
	2-1/2"	----
107007	3"	----
107009	4"	----
107011	6"	----
107012	8"	----
	10"	----
	12"	----

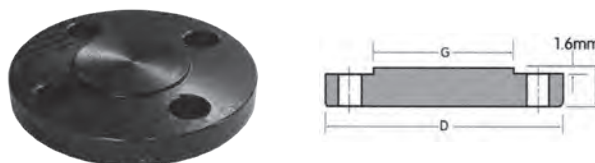

BLIND 1/16" RAISED FACE CARBON STEEL FLANGE

PART #	SIZE	
	1/2"	----
	3/4"	----
107042	1"	----
	1-1/4"	----
107044	1-1/2"	----
107045	2"	----
	2-1/2"	----
107047	3"	----
107049	4"	----
	6"	----
	8"	----
	10"	----
	12"	----

Nominal Pipe Size	Outside Diameter	O.D of Raised Face	Diameter at Base of Hub	Thickness	Welding Neck Socket Welding	Welding Neck	Slip-on Threaded Socket Welding
	D	G	X		T	B1	T1
1/2	3.504	1.382	1.189	.441	.618	1.882	.618
3/4	3.898	1.689	1.50	.50	.819	2.059	.618
1	4.252	2.00	1.941	.559	1.051	2.189	.689
1-1/4	4.606	2.50	2.311	.618	1.382	2.252	.811
1-1/2	5.00	2.882	2.559	.689	1.610	2.441	.882
2	5.984	3.618	3.059	.752	2.071	2.50	1.00
2-1/2	7.008	4.118	3.559	.882	2.469	2.752	1.118
3	7.52	5.00	4.252	.941	3.071	2.752	1.189
4	9.016	6.189	5.311	.941	4.031	3.00	1.311
6	10.984	8.50	7.559	1.00	6.071	3.50	1.559
8	13.504	10.618	9.689	1.118	7.980	4.00	1.752
10	15.984	12.752	12.00	1.189	10.02	4.00	1.941
12	19.016	15.00	14.382	1.252	12.00	4.50	2.189

WARNING: This product can expose you to chemicals, including Nickel, which are known to the State of California to cause cancer. For more information, visit www.P65Warnings.ca.gov



BLACK AND GALV. DUCTILE IRON REDUCING COMPANION FLANGES

NIPPLES AND FITTINGS

THREADED COMPANION FLANGE CLASS 125 PATTERN (BLACK & GALVANIZED)

- * DIMENSIONS, FACED AND DRILLED IN ACCORDANCE WITH ASME B16.42/AWWA C110
- * COATING: AVAILABLE IN BLACK ELECTROPHORETIC COATING AND HOT DIP GALVANIZED
- * HOT-DIPPED GALVANIZED CONFORM TO ASTM A153; COMPANION FLANGE THREADS CONFORM TO ASME B1.20.1
- * APPLICATION: WATERWORKS, PUMP, IRRIGATION
- * 150PSI



BLACK

PART #	DESCRIPTION (DI FLANGE)	A (INCH)	B (INCH)	C (INCH)	D (INCH)	BOLT HOLE SIZE	NO. OF HOLES	UNIT WEIGHT (KG)	
108075	3" x 2"	7.50	6.00	0.75	1.19	φ0.75	4	4.3827	----
108076	3" x 2-1/2"	7.50	6.00	0.75	1.19	φ0.75	4	4.2013	----
108077	4" x 1-1/2"	9.00	7.50	0.94	1.31	φ0.75	8	6.8352	----
108088	4" x 2"	9.00	7.50	0.94	1.31	φ0.75	8	6.4168	----
108089	4" x 2-1/2"	9.00	7.50	0.94	1.31	φ0.75	8	6.3343	----
108090	4" x 3"	9.00	7.50	0.94	1.31	φ0.75	8	6.081	----
108091	5" x 4"	10.00	8.50	0.94	1.44	φ0.875	8	6.8761	----
108094	6" x 2"	11.00	9.50	1.00	1.56	φ0.875	8	10.6349	----
108095	6" x 3"	11.00	9.50	1.00	1.56	φ0.875	8	10.1831	----
108092	6" x 4"	11.00	9.50	1.00	1.56	φ0.875	8	9.4563	----
108096	8" x 4"	13.50	11.75	1.12	1.75	φ0.875	8	17.1296	----
108097	8" x 6"	13.50	11.75	1.12	1.75	φ0.875	8	15.2184	----
108098	8" x 2"	16.00	14.25	1.19	1.94	φ1	12	26.54	----
108099									
108100									
108101									

GALVANIZED

108031	2-1/2" x 2"	6.00	4.75	0.75	1.19	φ0.75	4	3.623	
108032	3" x 2"	7.50	6.00	0.75	1.19	φ0.75	4	4.3827	
108033	3" x 2-1/2"	7.50	6.00	0.75	1.19	φ0.75	4	4.2013	----
108034	4" x 2"	9.00	7.50	0.94	1.31	φ0.75	8	6.4168	
108035	4" x 2-1/2"	9.00	7.50	0.94	1.31	φ0.75	8	6.3343	----
108036	4" x 3"	9.00	7.50	0.94	1.31	φ0.75	8	6.081	----
108038	6" x 2"	11.00	9.50	1.00	1.56	φ0.875	8	10.6349	----
108039	6" x 2-1/2"	11.00	9.50	1.00	1.56	φ0.875	8	10.5386	----
108037	6" x 4"	11.00	9.50	1.00	1.56	φ0.875	8	9.4563	----
108040	8" x 4"	13.50	11.75	1.12	1.75	φ0.875	8	17.1296	----
108041	8" x 6"	13.50	11.75	1.12	1.75	φ0.875	8	15.2184	

WARNING: This product can expose you to chemicals, including Nickel, which are known to the State of California to cause cancer. For more information, visit www.P65Warnings.ca.gov

BLACK AND GALVANIZED COMPANION FLANGES

NIPPLES AND FITTINGS

DUCTILE IRON THREADED COMPANION FLANGES

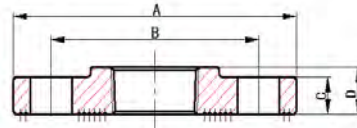

*DIMENSIONS, FACED AND DRILLED IN ACCORDANCE WITH ASME B16.42/AWWA C110

*COATING: AVAILABLE IN BLACK ELECTROPHORETIC COATING AND HOT DIP GALVANIZED

*HOT-DIPPED GALVANIZED CONFORM TO ASTM A153; COMPANION FLANGE THREADS CONFORM TO ASME B1.20.1

*APPLICATION: WATERWORKS, PUMP, IRRIGATION

BLACK

PART # (BLACK)	DESCRIPTION (THREADED)	SIZE (INCH)	A (INCH)	B (INCH)	C (INCH)	D (INCH)	BOLT HOLE SIZE	NO. OF HOLES	UNIT WEIGHT (KG)	
108062	1 150	1"	4.25	3.12	0.44	0.75	φ0.625	4	0.8347	----
108063	1 1/4 150	1-1/4"	4.62	3.5	0.5	0.81	φ0.625	4	1.0797	----
108064	1 1/2 150	1-1/2"	5	3.88	0.56	0.88	φ0.625	4	1.3217	----
108065	2 150	2"	6	4.75	0.62	1	φ0.75	4	2.1457	----
108066	2 1/2 150	2-1/2"	7	5.5	0.69	1.12	φ0.75	4	3.4182	----
108067	3 150	3"	7.5	6	0.75	1.19	φ0.75	4	3.9051	----
108069	4 150	4"	9	7.5	0.94	1.31	φ0.75	8	5.5254	----
108071	6 150	6"	11	9.5	1	1.56	φ0.875	8	7.5328	----
108072	8 150	8"	13.5	11.75	1.12	1.75	φ0.875	8	13.0201	----
108073	10 150	10"	16	14.25	1.19	1.94	φ1	12	22.854	----
108074	12 150	12"	19	17	1.25	2.19	φ1	12	26.5451	----

GALVANIZED

108025	2 150	2"	6	4.75	0.62	1	φ0.75	4	2.1457	----
108026	2 1/2 150	2-1/2"	7	5.5	0.69	1.12	φ0.75	4	3.4182	----
108027	3 150	3"	7.5	6	0.75	1.19	φ0.75	4	3.9051	----
108028	4 150	4"	9	7.5	0.94	1.31	φ0.75	8	5.5254	----
108029	6 150	6"	11	9.5	1	1.56	φ0.875	8	7.5328	----

BLIND FLANGES



PART # (BLACK)	DESCRIPTION (THREADED)	SIZE (INCH)	A (INCH)	B (INCH)	C (INCH)	BOLT HOLE SIZE	NO. OF HOLES	UNIT WEIGHT (KG)	
108065BF		2"	6	4.75	0.62	φ0.75	4	2.3731	
108067BF		3"	7.5	6	0.94	φ0.75	4	4.8547	
108069BF		4"	9	7.5	0.94	φ0.75	8	6.5341	
108071BF		5"	10	8.5	0.94	φ0.875	8	7.9894	
108070BF		6"	11	9.5	1	φ0.875	8	10.811	
108072BF		8"	13.5	11.75	1.12	φ0875	8	18.6264	
108073BF		10"	16	14.25	1.19	φ1	12	26.2487	

WARNING: This product can expose you to chemicals, including Nickel, which are known to the State of California to cause cancer. For more information, visit www.P65Warnings.ca.gov



WROT SOLDER JOINT

NIPPLES AND FITTINGS

COPPER FITTINGS



SYMBOL OF JOINT ENDS

- C** Solder joint fitting end made to receive copper tube diameter
 - Ftg.** Solder joint fitting end made to copper tube diameter
 - F** Internal ANSI Standard Taper Pipe Thread-Female
 - M** External ANSI Standard Taper Pipe Thread-Male
- Threaded ends ANSI/ ASME B1. Solder ends ASTM B88

- Temp range 32° to 200°F
- Pressure @100° - 1/8-1 : 500 PSI
- 1-1/4-2 : 400 PSI
- 2-1/2 - 3: 300 PSI

**NSF - 61 CERTIFIED
ALLOY C12200**

PRICING FILE AVAILABLE ONLINE

THE ABOVE CONFORMS TO ASTM B 88 & ASTM B 306, A 306

Nom- inal Size	Joint Ends										Metal Thick- ness T (in)	Inside Diam- eter O (in)
	Male End					Female End						
	Outside Diam- eter (A) in	Average Toler- ance (mm)	Ac- tual MIN in	O.D. MAX in		Inside Diam- eter F (in)	Average Toler- ance (mm)	Ac- tual MIN in	O.D. MAX in			
1/8	2/8	0.03	2/8	2/8	3/8	2/8	0.03	2/8	2/8	3/8	0	2/8
1/4	3/8		3/8	3/8	3/8	3/8		3/8	3/8	3/8	0	2/8
3/8	4/8		4/8	4/8	3/8	4/8		4/8	4/8	3/8	0	3/8
1/2	5/8		5/8	5/8	4/8	5/8		5/8	5/8	3/8	0	4/8
5/8	6/8		6/8	6/8	5/8	6/8		6/8	6/8	5/8	0	4/8
3/4	7/8		7/8	7/8	6/8	7/8		7/8	7/8	5/8	0	5/8

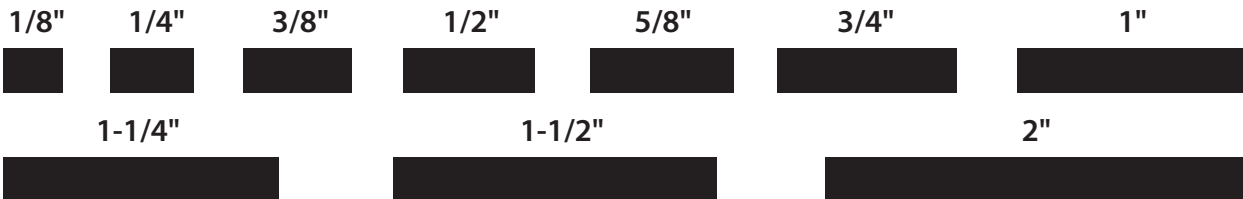

WARNING: This product can expose you to chemicals, including Nickel, which are known to the State of California to cause cancer. For more information, visit www.P65Warnings.ca.gov

WROT SOLDER JOINT

NIPPLES AND FITTINGS

90° ELL C X C



PART#	NOMINAL (ID)	OD	APPROX NET WT.	IND #	
77101	1/4"	3/8"	0.01	W 02009	----
77102	3/8"	1/2"	0.03	W 02017	----
77104	1/2"	5/8"	0.04	W 02022	----
77108	3/4"	7/8"	0.09	W 02034	----
77110	1"	1-1/8"	0.17	W 02047	----
77113	1-1/4"	1-3/8"	0.27	W 02077	----
77114	1-1/2"	1-5/8"	0.41	W 02085	----
77116	2"	2-1/8"	0.73	W 02086	----
77119	3"				

WE-500-R 607-R 107-C

90° STREET ELL FTG. X C



PART#	NOMINAL (ID)	OD	APPROX NET WT.	IND #	
77124	1/4"	3/8"	0.01	W 02312	----
77125	3/8"	1/2"	0.03	W 02321	----
77126	1/2"	5/8"	0.05	W 01652	----
77128	3/4"	7/8"	0.12	W 01654	----
77129	1"	1-1/8"	0.22	W 02344	----
77130	1-1/4"	1-3/8"	0.33	W 02384	----
77131	1-1/2"	1-5/8"	0.45	W 02385	----
77132	2"	2-1/8"	0.87	W 02386	----
77134	3"				

90° LONG TURN ELL C X C



PART#	NOMINAL (ID)	OD	APPROX NET WT.	IND #	
77143	1/2"	5/8"	0.06	W 02722	----
77144	5/8"	3/4"	0.10	W 02728	----
77145	3/4"	7/8"	0.15	W 02734	----

WE-500-L 607-LT 107-L

90° LONG TURN ST. ELL FTG. X C



PART#	NOMINAL (ID)	OD	APPROX NET WT.	IND #	
77156	5/8"	3/4"	0.11		----
77159	1-1/4"	1-3/8"	0.46	W 02828	----
77160	1-1/2"	1-5/8"	0.64	W 02834	----

WE-503-L 607-2LT

45° ELL C X C



PART#	NOMINAL	APPROX NET WT.	IND #	
77163	3/8"	0.02	W 03021	----
77164	1/2"	0.04	W 03026	----
77166	3/4"	0.10	W 03034	----
77167	1"	0.19	W 03044	----
77168	1-1/4"	0.27	W 03050	----
77169	1-1/2"	0.39	W 03055	----
77170	2"	0.75	W 03059	----

WE-504 606 106

* See midlandindustries.com for larger sizes

WARNING: This product can expose you to chemicals, including Nickel, which are known to the State of California to cause cancer. For more information, visit www.P65Warnings.ca.gov

WROT SOLDER JOINT

NIPPLES AND FITTINGS

STREET 45° FTG. X C



PART#	NOMINAL	APPROX NET WT.	IND #	
77179	1/2"	0.06	W 03326	----
77181	3/4"	0.10	W 03334	----
77182	1"	0.18	W 03344	----
77183	1-1/4"	0.27	W 03350	----

WE-505 606-2

COUPLING (SOCKET) W/ ROLLED UP TUBE STOP C X C



PART#	NOMINAL	APPROX NET WT.	IND #	
77201	1/8"	0.01	W 01003	----
77202	1/4"	0.01	W 01009	----
77203	3/8"	0.02	W 01017	----
77204	1/2"	0.03	W 01022	----
77205	5/8"	0.04	W 01028	----
77206	3/4"	0.06	W 01034	----
77207	1"	0.10	W 01047	----
77208	1-1/4"	0.15	W 01055	----
77209	1-1/2"	0.22	W 01063	----
77210	2"	0.39	W 01072	----
77212	3"			

WC-400 100

COUPLING (SOCKET) LESS TUBE STOP C X C



PART#	NOMINAL	APPROX NET WT.	IND #	
77220	1/4"	0.01	W 01901	----
77222	1/2"	0.03	W 01903	----
77223	3/4"	0.06	W 01905	----
77224	1"	0.10	W 01906	----
77225	1-1/4"	0.15	W 01907	----
77226	1-1/2"	0.22	W 01908	----
77227	2"	0.39	W 01909	----

WC-400NS 601

COUPLING (SOCKET) W/ DIMPLED TUBE STOP C X C



PART#	NOMINAL	APPROX NET WT.	IND #	
77238	1/2"	0.03		----
77240	3/4"	0.06		----
77241	1"	0.10		----

WC-400S

WARNING: This product can expose you to chemicals, including Nickel, which are known to the State of California to cause cancer. For more information, visit www.P65Warnings.ca.gov

NIPPLES & FITTINGS

* See midlandindustries.com for larger sizes

WROT SOLDER JOINT

NIPPLES AND FITTINGS

REDUCER COUPLING W/ STOP C X C



PART#	NOMINAL	APPROX NET WT.	IND #	
77252	1/4" x 1/8"	0.01	W 01011	----
77253	3/8" x 1/4"	0.02	W 01019	----
77256	1/2" x 1/4"	0.03	W 01023	----
77255	1/2" x 3/8"	0.03	W 01021	----
77258	5/8" x 1/2"	0.04	W 01025	----
77262	3/4" x 1/2"	0.06	W 01029	----
77267	1"x1/2"	0.10	W 01049	----
77265	1"x3/4"	0.12	W 01038	----
77269	1 -1/4" x 3/4"	0.17	W 01056	----
77268	1-1/4" x 1"	0.17	W 01051	----
77272	1-1/2" x1"	0.24	W 01064	----
77271	1-1/2" x 1-1/4"	0.24	W 01060	----
77277	2" x 1"	0.48	W 01074	----
77276	2 x 1-1/4"	0.46	W 01073	----
77275	2" x 1-1/2"	0.42	W 01069	----

• 21 more sizes available - see website

WC-400R 600-R

FITTING REDUCER FTG. C X C



PART#	NOMINAL	APPROX NET WT.	IND #	
77294	1/2" x 1/4"	0.03	W 01317	----
77298	3/4" x 3/8"	0.05	W 01327	----
77297	3/4" x 1/2"	0.06	W 01326	----
77352	1" x 1/2"	0.10	W 01265	----
77300	1"x3/4"	0.11	W 01337	----
77355	1 -1/4" x 3/4"	0.15	W 01345	----
77354	1-1/4" x1"	0.17	W 01343	----
77359	1 -1/2" x 3/4"	0.21	W 01353	----
77358	1-1/2"x1"	0.22	W 01351	----
77357	1 -1/2" X 1-1/4"	0.21	W 01350	----
77361	2" x 1-1/2"	0.39	W 01358	----

WC-403 600-2

MALE ADAPTER C X M

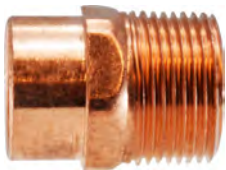

PART#	NOMINAL	APPROX NET WT.	IND #	
77398	3/8"	0.06	W 01125	----
77401	1/2"	0.08	WB01131	----
77306	3/4"	0.14	WB01146	----
77309	1"	0.24	WB01163	----
77314	1-1/4"	0.41	W 01171	----
77318	1-1/2"	0.50	W 01179	----
77322	2"	0.87	W 01187	----
77308	3/8" x 1/2"			
77311	1/2" x 3/8"	0.18		----
77315	3/4" x 1/2"	0.31		----
77307	3/4" x 1"	0.29	W 01145	----
77312	1" x 3/4"	0.18	W 01164	----

• 14 more reducing sizes available

WC-401 604

* See midlandindustries.com for more sizes

WARNING: This product can expose you to chemicals, including Nickel, which are known to the State of California to cause cancer. For more information, visit www.P65Warnings.ca.gov

WROT SOLDER JOINT

NIPPLES AND FITTINGS

FTG. MALE ADAPTER FTG. X M

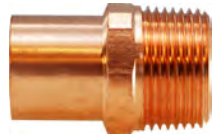

PART#	NOMINAL	APPROX NET WT.	IND #	
77331	1/2"	0.09	W 01431	----
77333	3/4"	0.15	W 01446	----
77334	1"	0.15	W 01463	----
77335	1-1/4"	0.41	W 01471	----

WC-404 604-2

COPPER TUBING

SEE COPPER TUBING FOR REFRIGERATION AND DRINKING WATER

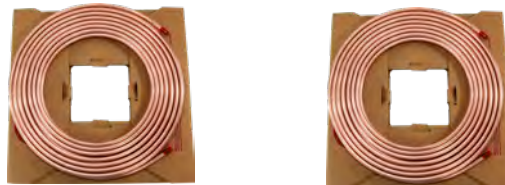

FEMALE ADAPTERS C X F



PART#	NOMINAL	APPROX NET WT.	IND #	
77340	3/8"			
77343	1/2"	0.10	WB01231	----
77349	3/4"	0.14	WB01246	----
77402	1"	0.24	WB01263	----
77406	1-1/4"	0.43	W 01271	----
77410	1-1/2"	0.58	W 01279	----
77413	2"	0.74	W 01287	----
77341	3/8" x 1/2"	0.10	W 01224	----
77347	1/2" x 1/4"	0.05	W 01233	----
77346	1/2" x 3/8"	0.70	W 01232	----
77345	1/2" x 3/4"	0.15	WB01230	----

FEMALE FTG. ADAPT. FTG. X F



PART#	NOMINAL	APPROX NET WT.	IND #	
77420	1/2"	0.11	W 01531	----
77423	3/4"	0.19	W 01546	----
77424	1			----
77425	1 1/4			----

WC405 603-2 WC405R 603R

CAP



PART#	NOMINAL	APPROX NET WT.	IND #	
77430	3/8"	0.01	W 07006	----
77431	1/2"	0.02	WB07007	----
77432	5/8"	0.03	W 07008	----
77433	3/4"	0.04	WB07009	----
77434	1"	0.08	WB07011	----
77435	1-1/4"	0.11	W 07012	----
77436	1-1/2"	0.18	W 07013	----
77437	2"	0.30	W 07014	----

• More sizes available

WC402 603 WC402R 603R

WARNING: This product can expose you to chemicals, including Nickel, which are known to the State of California to cause cancer. For more information, visit www.P65Warnings.ca.gov

NIPPLES & FITTINGS

WROT SOLDER JOINT

NIPPLES AND FITTINGS

UNIONS C X C

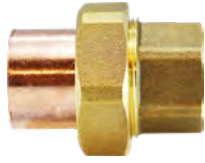

• LF = Lead Free

PART#	NOMINAL	APPROX NET WT.	IND #	
77455LF	1/2"	0.17	W 08003	----
77456LF	3/4"	0.37	W 08004	----
77457LF	1"	0.51	W 08005	----
77606LF	1-1/4"	0.98	W08006	----
77607LF	1-1/2"	1.21	W08007	----
77608LF	2"		W08008	----

WC-415 617

U-TYPE STRAP



PART#	NOMINAL	APPROX NET WT.	IND #	
77461	1/2"	0.03	A 02529	----
77462	3/4"	0.03	A 02574	----

WC-407
WS-1100

TEE C X C X C



PART#	NOMINAL 1 X 2 X 3	APPROX NET WT.	IND #	
77467	1/8"	0.02	W 40306	----
77468	1/4"	0.03	W 04000	----
77470	3/8"	0.05	W 04001	----
77473	1/2"	0.08	WB04006	----
77483	3/4"	0.18	WB04031	----
77490	1"	0.35	WB04048	----
77504	1-1/4"	0.58	W 04068	----
77519	1-1/2"	0.72	W 04084	----
77543	2"	1.35	W 40102	----
77489	3/4"x1/2"x1/2"	0.15	WB04043	----
77488	3/4" x 1/2" x 3/4"	0.19	WB04041	----
77486	3/4" x 3/4" x 1/2"	0.15	WB04033	----
77485	3/4"x3/4"x1"	0.25	W 04065	----
77501	1"x1/2"x1"	0.34	W 04061	----
77499	1"x3/4"x3/4"	0.31	W 04056	----
77496	1"x1"x1/2"	0.24	WB04051	----
77493	1"x1"x3/4"	0.29	WB04049	----
77523	1-1/2" x 1-1/2" x 3/4"	0.51	W 04087	----
77522	1-1/2" x 1-1/2" x 1"	0.60	W 04086	----
77547	2"x2"x1"	0.99	W 40105	----

WT-600 611

DROP EAR ELBOWS



• Lead Free Bronze • Lead Free Brass

PART #	SWT X FIP	
44840LF	1/2 x 1/2 Bronze	----
44841LF	1/2 x 1/2 Brass	----
44842LF	3/4 x 1/2 Brass	----
44843LF	3/4 x 3/4 Brass	----



• Lead Free Brass

PART #	SWT X SWT	
44844LF	1/2 x 1/2	----



• Lead Free Bronze

PART #	PEX X FIP	
44845LF	1/2 x 1/2	----

WARNING: This product can expose you to chemicals, including Nickel, which are known to the State of California to cause cancer. For more information, visit www.P65Warnings.ca.gov

