

IRWIN®

Wood Drilling













www.irwin.com

A Century of Quality and Innovation

In 1885, the IRWIN® Auger Bit Company was formed. Over 125 years later, IRWIN is still the leading manufacturer of wood drilling bits and accessories. No matter what wood drilling project you face, IRWIN Tools makes a drill bit that performs the job better. Our mark of quality is stamped right on the shank of our full range of bits. Whether the job requires quick, clean holes, or precise finish work, IRWIN has a bit for every application and every need.

The all new IRWIN SPEEDBOR® with Weldtec™ Ship Auger Bits are MADE STRONGER and LAST LONGER. With a patent-pending WeldTec cutting edge, these bits are durable, and have twice the nail cutting life of traditional ship auger bits. The bits are fully forged, for added durability; have an aggressive screw pitch for faster drilling; and wide flutes for maximum chip removal. Only IRWIN offers the superior performance and added durability of WeldTec.

Use the chart below to determine which bit is best for the job at hand.

Bit Style	Size Range	Typical Trades	Application Benefits
 <p>Tri-Flute Bit</p>	7/16" to 1-1/2" diameter	Carpentry, Electrical, Plumbing	Fast, clean holes with reduced "break out" when through-hole drilling. Full screw-tip requires less effort.
 <p>Spade Bit</p>	1/4" to 1-1/2" diameter 4-3/4" to 16" lengths	Carpentry, Electrical, Plumbing	Fast, clean holes with reduced "break out" when through-hole drilling.
 <p>I-100 Solid Center Auger Bit</p>	1/4" to 1-1/2" diameter 7-1/2" length	Carpentry, Electrical, Plumbing	Self-feeding tip pulls bit into the work for repetitive cutting of fast clean holes with a clean exit hole. Single-spur cutting edge scribes the circumference of the hole for a smoother finish.
 <p>Ship Auger Bit</p>	3/8" to 2" diameter 7-1/2" to 29" lengths	Public Utilities, Electrical, Plumbing, Carpentry, Log Homes	Hollow center provides better chip removal for deeper holes in utility poles and logs.
 <p>Installer Bit</p>	1/4" to 3/4" diameter 12" to 30" lengths	Telecommunications, Cable/Internet, Security Systems	Wire hole near the end of the bit enables user to pull wire back through after drilling the hole.
 <p>Self-Feed Bit</p>	1" to 4-5/8" diameter	Plumbing, Electrical, General Contracting	Replaceable self-feeding tip pulls bit into the wood. For cutting larger holes with clean edges.
 <p>Forstner Bit</p>	1/4" to 2-1/8" diameter	Fine Woodworking, Cabinet Making	Precise cutting of smooth, flat-bottomed (blind) holes with clean, sharp edges.
 <p>Brad Point Bit</p>	1/8" to 1/2" diameter	Woodworking, Cabinet Making	Precise cutting of smooth through-holes with clean, sharp edges and reduced "break out."
 <p>Countersink Bit</p>	1/8" to 1/2" diameter	Woodworking, Cabinet Making	Perfect for variable-size countersink holes.
 <p>Plug Cutters</p>	1/8" to 1/2" diameter	Woodworking, Cabinet Making	Perfect for cutting dowels or plug holes.
 <p>Quick Change Extensions</p>	1/4" available in 2", 6" and 12" length 3/8" available in 2", 5-1/2" and 12" length 7/16" available in 5-1/2", 12" and 18" length	Woodworking, Cabinet Making	Lock-n-Load one-handed quick release.

SPEEDBOR® Max Speed Bits

SPEEDBOR MAX SPEED BIT FEATURES

1. Cutting spurs have three cutting edges for added durability
2. Full screw tip allows bit to self feed
3. Tri-flute design for faster chip ejection
4. Grooved hex shank prevents slipping in drill chuck or bit extension, fits all standard 1/4" quick change chucks

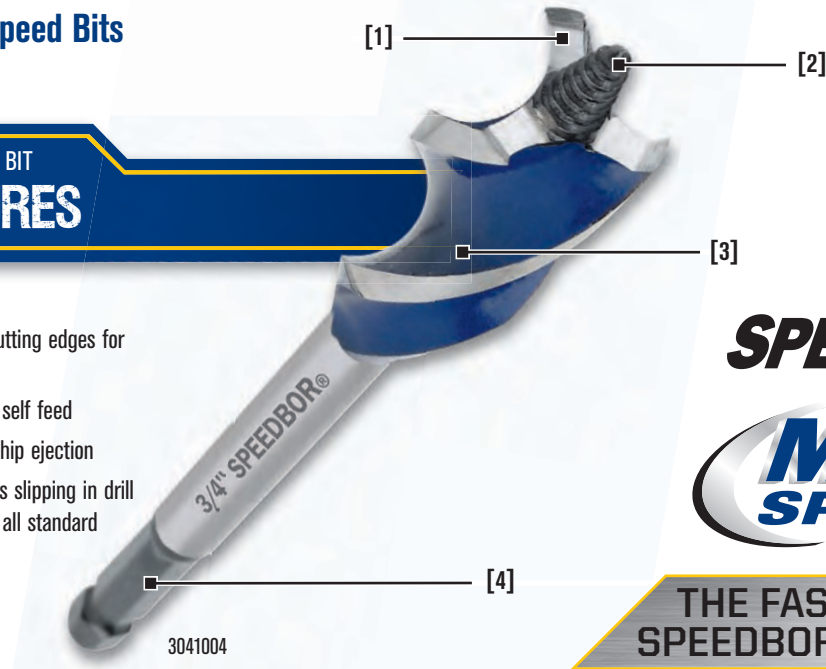

**THE FASTEST
SPEEDBOR EVER.**

6-piece SPEEDBOR MAX Speed Set



3041006

3-piece SPEEDBOR MAX Speed Set



3041003

Quick Change Extension



4935704

Diameter	Description	Shank Size	Item#	Pack Qty	Bulk Item #	Pack Qty
7/16"	7/16" x 6" SPEEDBOR MAX Speed Drill Bit	1/4" Hex	3041015	3	3041015B	6
1/2"	1/2" x 6" SPEEDBOR MAX Speed Drill Bit	1/4" Hex	3041001	3	3041001B	6
9/16"	9/16" x 6" SPEEDBOR MAX Speed Drill Bit	1/4" Hex	3041014	3	3041014B	6
5/8"	5/8" x 6" SPEEDBOR MAX Speed Drill Bit	1/4" Hex	3041002	3	3041002B	6
11/16"	7/8" x 6" SPEEDBOR MAX Speed Drill Bit	1/4" Hex	3041016	3	3041016B	6
3/4"	3/4" x 6" SPEEDBOR MAX Speed Drill Bit	1/4" Hex	3041004	3	3041004B	6
13/16"	13/16" x 6" SPEEDBOR MAX Speed Drill Bit	1/4" Hex	3041017	3	3041017B	6
7/8"	7/8" x 6" SPEEDBOR MAX Speed Drill Bit	1/4" Hex	3041005	3	3041005B	6
15/16"	15/16" x 6" SPEEDBOR MAX Speed Drill Bit	1/4" Hex	3041018	3	3041018B	6
1"	1" x 6" SPEEDBOR MAX Speed Drill Bit	1/4" Hex	3041007	3	3041007B	6
1-1/8"	1-1/8" x 6" SPEEDBOR MAX Speed Drill Bit	1/4" Hex	3041019	3	3041019B	6
1-1/4"	1-1/4" x 6" SPEEDBOR MAX Speed Drill Bit	1/4" Hex	3041009	3	3041009B	6
1-3/8"	1-3/8" x 6" SPEEDBOR MAX Speed Drill Bit	3/8" Hex	3041020	3	3041020B	6
1-1/2"	1-1/2" x 6" SPEEDBOR MAX Speed Drill Bit	3/8" Hex	3041021	3	3041021B	6

Sets

-	3pc Set SPEEDBOR MAX Speed (5/8", 3/4", 1")	3041003	6	-	-
-	6pc Set SPEEDBOR MAX Speed (1/2", 5/8", 3/4", 7/8", 1" & 1-1/4")	3041006	6	-	-

Lock-n-Load® Quick Change Extensions

1/4"	Quick Change Bit Holder 2" OAL (fits 7/16" - 1-1/4")	4935703	6	-	-
1/4"	Quick Change Bit Holder 6" OAL (fits 7/16" - 1-1/4")	4935704	6	-	-
1/4"	Quick Change Bit Holder 12" OAL (fits 7/16" - 1-1/4")	4935705	6	-	-
3/8"	Quick Change Bit Holder 2" OAL (fits 1-3/8" & 1-1/2")	4935651	6	-	-
3/8"	Quick Change Bit Holder 5-1/2" OAL (fits 1-3/8" & 1-1/2")	4935652	3	-	-
3/8"	Quick Change Bit Holder 12" OAL (fits 1-3/8" & 1-1/2")	4935653	3	-	-

SPEEDBOR® Spade Bits

SPEEDBOR SPADE BIT FEATURES

1. Double Cutting Spurs Scribe the outside of the hole, reducing breakout
2. Thicker Cutting Edge For longer drilling life
3. Patented BLUE-GROOVE Point & Cutting Edge for faster chip removal
4. Larger Shank for durability
5. Quick Change Shank fits all standard 1/4" quick change chucks

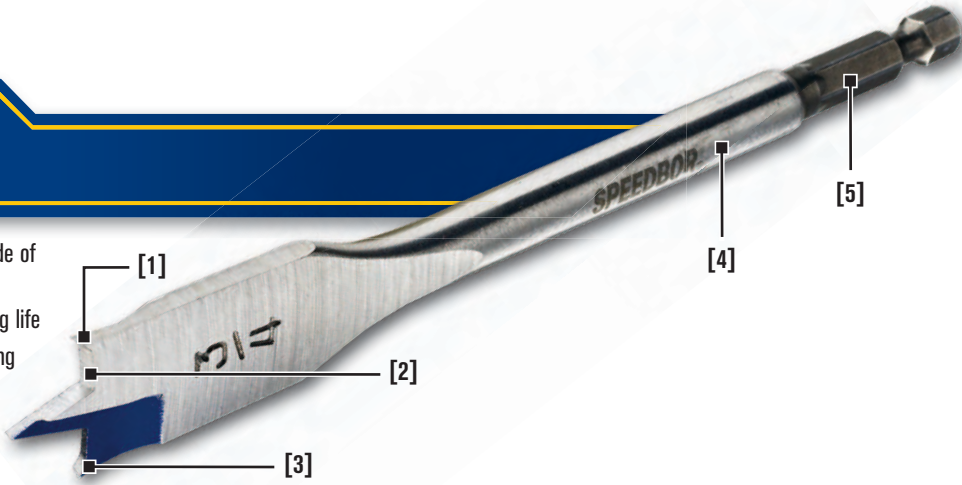

87912

4-3/4" SPEEDBOR Short Length Spade Bits

- For drilling in tight spaces



88812

6" SPEEDBOR Standard Length Spade Bits

Diameter	Length	Shank Size	Item #	Pack Qty
1/2"	4"	1/4" Hex	87908	6
5/8"	4"	1/4" Hex	87910	6
3/4"	4"	1/4" Hex	87912	6
7/8"	4"	1/4" Hex	87914	6
1"	4"	1/4" Hex	87916	6
1-1/4"	4"	1/4" Hex	87920	3
1-1/2"	4"	1/4" Hex	87924	3

Diameter	Length	Shank Size	Item #	Pack Qty	Bulk Item #	Pack Qty
1/4"	6"	1/4" Hex	88804	6	99904	24
5/16"	6"	1/4" Hex	88805	6	99905	24
3/8"	6"	1/4" Hex	88806	6	99906	24
7/16"	6"	1/4" Hex	88807	6	99907	24
1/2"	6"	1/4" Hex	88808	6	99908	24
9/16"	6"	1/4" Hex	88809	6	99909	24
5/8"	6"	1/4" Hex	88810	6	99910	24
11/16"	6"	1/4" Hex	88811	6	99911	24
3/4"	6"	1/4" Hex	88812	6	99912	24
13/16"	6"	1/4" Hex	88813	6	99913	24
7/8"	6"	1/4" Hex	88814	6	99914	24
15/16"	6"	1/4" Hex	88815	6	99915	24
1"	6"	1/4" Hex	88816	6	99916	24
1-1/8"	6"	1/4" Hex	88818	3	99918	12
1-1/4"	6"	1/4" Hex	88820	3	99920	12
1-3/8"	6"	1/4" Hex	88822	3	99922	12
1-1/2"	6"	1/4" Hex	88824	3	99924	12

Bulk 4 PC Value Packs

5/8"	6"	1/4" Hex	1764343	6	-	-
3/4"	6"	1/4" Hex	1764344	6	-	-
1"	6"	1/4" Hex	1764345	6	-	-



88712

16" SPEEDBOR Extra-Long Spade Bits

- For extended reach
- Not for use with bit extensions or drill presses

Diameter	Length	Shank Size	Item #	Pack Qty	Bulk Item #	Pack Qty
3/8"	16"	1/4" Hex	88706	6	99706	24
1/2"	16"	1/4" Hex	88708	6	99708	24
5/8"	16"	1/4" Hex	88710	6	-	-
3/4"	16"	1/4" Hex	88712	6	99712	24
7/8"	16"	1/4" Hex	88714	6	99714	24
1"	16"	1/4" Hex	88716	6	99716	24

SPEEDBOR® Short Length Spade Bit Sets



1768411

SPEEDBOR Spade Bit Sets



88885

SPEEDBOR Pro Set



341008

- Sliding latch design provides added security

Standard Spurless Shape Bits



88012BULK

Description	Diameter	Item #	Pack Qty
Short Length Spade Bit Sets			
3-pc set	1/2", 3/4", 1"	87950	6
		87954	
6pc PRO Set w/Extension	3/4", 7/8", 15/16", 1", 1-1/8" & 6" Extension	1768411	6
	Nylon PRO Set Case		
Standard Length Spade Bit Sets			
3pc Set	1/2", 3/4", 1"	88889	6
4pc Set w/Extension	1/2", 3/4", 1", & 6" Quick Change Extension	4935687	6
5pc Set	3/8", 1/2", 5/8", 3/4", 1"	88885	6
6pc Set	3/8", 1/2", 5/8", 3/4", 7/8", 1"	88886	6
6pc Set w/Workshop Rack	3/8", 1/2", 5/8", 3/4", 7/8", 1" & Rack	88888	6
6pc Set w/Slim Case	3/8", 1/2", 5/8", 3/4", 7/8", 1" & Slim Case	88890	6
6pc Set w/Extension	3/8", 1/2", 5/8", 3/4", 1" & 6" Quick Change Extension	88898	6
8pc PRO Set Case	3/8", 1/2", 5/8", 7/8", 1", 1-1/8", 1-1/2" & PRO Set Case	341008	6
13pc Set	1/4", 5/16", 3/8", 7/16", 1/2", 9/16", 5/8", 11/16", 3/4", 13/16", 7/8", 15/16", 1"	88894	6
13pc Set w/Workshop Rack	1/4", 5/16", 3/8", 7/16", 1/2", 9/16", 5/8", 11/16", 3/4", 13/16", 7/8", 15/16", 1"	88887	6
Lock-n-Load® Quick Change Extensions			
1/4" Quick Change Bit Holder 2" OAL		4935703	6
1/4" Quick Change Bit Holder 6" OAL		4935704	6
1/4" Quick Change Bit Holder 12" OAL		4935705	6

Diameter	Length	Shank Size	Bulk Item #	Pack Qty
3/8"	6"	1/4" Hex	88006BULK	24
7/16"	6"	1/4" Hex	88007BULK	24
1/2"	6"	1/4" Hex	88008BULK	24
9/16"	6"	1/4" Hex	88009BULK	24
5/8"	6"	1/4" Hex	88010BULK	24
11/16"	6"	1/4" Hex	88011BULK	24
3/4"	6"	1/4" Hex	88012BULK	24
13/16"	6"	1/4" Hex	88013BULK	24
7/8"	6"	1/4" Hex	88014BULK	24
15/16"	6"	1/4" Hex	88015BULK	24
1"	6"	1/4" Hex	88016BULK	24
1-1/8"	6"	1/4" Hex	88018BULK	24
1-1/4"	6"	1/4" Hex	88020BULK	24
1-3/8"	6"	1/4" Hex	88022BULK	24
1-1/2"	6"	1/4" Hex	88024BULK	24

IRWIN® Lock-n-Load® Quick Change Extensions

QUICK CHANGE BIT EXTENSION FEATURES

1. Carbon steel construction sleeve and body for durability and life
2. Lock-n-Load® system for one-handed quick release
3. Patented jaw design holds bits securely on 6-flatted shanks, as well as ball detent bits
4. 1/4" Quick Change range now holds insert bits; magnetic for holding



4935652



Lock-n-Load Compatibility

WOOD DRILLING

1/4"



- SPEEDBOR Blue Groove (All Sizes)
- SPEEDBOR Max Speed (Sizes 7/16" to 1-1/4")
- Fastener Drive (All products)
- UNIBIT® (Sizes #1, #2, #10, #12)
- 1/4 Hole Saw Arbor (Sizes 9/16" to 1-3/16")
- Countersinks (Sizes #4 to #12)

3/8"



- SPEEDBOR Max Speed (Sizes 1-3/8", 1-1/4")
- UNIBIT (Sizes #3, #4, #11)
- 1/4 Hole Saw Arbor (Sizes 9/16" to 6" diameter saws)

7/16"



- 17" Ship Augers (Sizes 9/16" and larger)
- 7-1/2" Short Ship Augers (Sizes 1-1/8", 1-1/4")
- Self-Feed Bits (All sizes)
- UNIBIT (Sizes #5, #9, #13, #14, #20, #21)



4935704

Shank Size	Length	Item #	Pack Qty
1/4"	2" OAL	4935703	6
1/4"	6" OAL	4935704	6
1/4"	12" OAL	4935705	6
3/8"	2" OAL	4935651	6
3/8"	5-1/2" OAL	4935652	3
3/8"	12" OAL	4935653	3
7/16"	5-1/2" OAL	4935654	3
7/16"	12" OAL	4935655	3
7/16"	18" OAL	4935656	3

Ship Auger Bits

IRWIN revolutionizes cutting and drilling tools with the patent-pending WeldTec™ cutting edge. The new IRWIN SPEEDBOR® with WeldTec Ship Auger Bits are **MADE STRONGER** and **LAST LONGER** because a harder cutting edge is welded to the base material. The result is **2X** longer nail cutting life versus traditional ship auger bits. The superior performance and durability of WeldTec is only available from IRWIN.

SHIP AUGER BIT

FEATURES

1. Patent-pending welded cutting edge for increased durability
2. Aggressive screw pitch for faster drilling
3. Wide flutes for maximum chip removal
4. 7/16" Quick Change impact shank for fast bit changes

[4]

3043011

[3]

[1]

[2]

WITH **WELDTEC™**

2X NAIL CUTTING LIFE*



17" Long Ship Auger Bits with WeldTec™

- Fully forged bit** for increased durability

Diameter	Twist Length	Overall Length	Tubed Item #	Pack Qty	Bulk Item #	Pack Qty
3/8"	12"	17"	3043004	1	3043004B	6
7/16"	12"	17"	4935570	1	4935571	6
1/2"	12"	17"	3043005	1	3043005B	6
9/16"	12"	17"	3043006	1	3043006B	6
5/8"	12"	17"	3043007	1	3043007B	6
11/16"	12"	17"	3043008	1	3043008B	6
3/4"	12"	17"	3043009	1	3043009B	6
13/16"	12"	17"	3043010	1	3043010B	6
7/8"	12"	17"	3043011	1	3043011B	6
15/16"	12"	17"	3043012	1	3043012B	6
1"	12"	17"	3043013	1	3043013B	6
1-1/16"	12"	17"	4935572	1	4935573	
1-1/8"	12"	17"	3043014	1	3043014B	6
1-1/4"	12"	17"	3043015	1	3043015B	6
1-3/8"	12"	17"	4935574		4935575	
1-1/2"	12"	17"	3043016	1	3043016B	6

* Compared to standard IRWIN ship augers
** Fully forged on bits 3/4" diameter and larger



7-1/2" Short Ship Auger Bits

- Cuts through nails without damaging the bit
- Short length allows bit to be used in tight areas
- Hex shank prevents slipping in drill chuck

Diameter	Shank Size	Twist Length	Overall Length	Tubed Item #
5/8"	5/16"	5"	7-1/2"	42410
11/16"	5/16"	5"	7-1/2"	42411
3/4"	5/16"	5"	7-1/2"	42412
13/16"	5/16"	5"	7-1/2"	42413
7/8"	5/16"	5"	7-1/2"	42414
1"	5/16"	5"	7-1/2"	42416
1-1/8"	7/16"	5"	7-1/2"	42418
1-1/4"	7/16"	5"	7-1/2"	42420

Wood Drilling

Hollow Center Auger Bits



46616



Utility Pole Auger Bits – Hand Brace Shank

- Extra-long twist is ideal for drilling large poles, construction timbers, and for other timber applications
- Cutting spur scribes the outside of the hole during drilling for a smooth, clean hole
- Remove the taper square shank and use in an electric drill or hand brace
- Bit can be resharpened
- Medium-fast screw point ideal for general wood drilling applications

Diameter	Shank Type	Twist Length	Overall Length	Bulk Item #	Pack Qty.
3/8"	Taper square	12"	18"	46606	6
7/16"	Taper square	12"	18"	46607	6
1/2"	Taper square	12"	18"	46608	6
9/16"	Taper square	12"	18"	46609	6
5/8"	Taper square	12"	18"	46610	6
11/16"	Adapter shank	12"	18"	46611	6
3/4"	Adapter shank	12"	18"	46612	6
13/16"	Adapter shank	12"	18"	46613ZR	6
7/8"	Adapter shank	12"	18"	46614	6
15/16"	Adapter shank	12"	18"	46615	6
1"	Adapter shank	12"	18"	46616	6
1-1/16"	7/16" hex	12"	18"	46617	3
11/16"	7/16" hex	18"	24"	46711	6
13/16"	7/16" hex	18"	24"	46713ZR	6
1"	7/16" hex	18"	24"	46716	6

Adapter Shank

Fits both hand braces and power drills



Taper square shank fits hand braces



Cut off or square and use in both power drills and hand braces

WOOD DRILLING



47915



Utility Pole Auger Bits – Impact Shank

- Extra-long twist is ideal for drilling large poles, construction timbers, and for other timber applications
- Cutting spur scribes the outside of the hole during drilling for a smooth, clean hole
- Hex shank design for use in impact wrench drills
- Bit can be resharpened
- Medium-fast screw point ideal for general wood drilling applications

Diameter	Shank Size	Twist Length	Overall Length	Bulk Item #	Pack Qty.
13/16"	5/8"	15"	18"	48113	6
11/16"	5/8"	15"	18"	48111ZR	6
9/16"	5/8"	15"	18"	48109	6
1-1/16"	7/16"	15"	18"	47917	3
15/16"	7/16"	15"	18"	47915	6
13/16"	7/16"	15"	18"	47913	6
11/16"	7/16"	15"	18"	47911	6
9/16"	7/16"	15"	18"	47909	6
1-1/16"	5/8"	21"	24"	48317	3
15/16"	5/8"	21"	24"	48315	3
13/16"	5/8"	21"	24"	48313	6
11/16"	5/8"	21"	24"	48311	6
15/16"	7/16"	21"	24"	48215	3
13/16"	7/16"	21"	24"	48213ZR	6
11/16"	7/16"	21"	24"	48211	6



47016



Pole Auger Bits – Hex Shank

- Extra-long twist is ideal for drilling in large poles, construction timbers, and for multiple timber applications
- All bits feature 7/16" adaptable hex shank. Simply remove it to use round shank
- Bit can be resharpened
- Medium-fast screw point is ideal for general wood drilling applications
- Cutting spur scribes the outside of the hole during drilling for a smooth, clean hole

Diameter	Twist Length	Overall Length	Bulk Item #	Pack Qty
9/16"	12"	17"	46809	6
5/8"	12"	17"	46810	6
11/16"	12"	17"	46811	6
3/4"	12"	17"	46812	6
13/16"	12"	17"	46813	6
9/16"	12"	23"	46909	6
5/8"	18"	23"	46910	6
11/16"	18"	23"	46911	6
3/4"	18"	23"	46912	6
13/16"	18"	23"	46913ZR	6
7/8"	18"	23"	46914ZR	6
15/16"	18"	23"	46915ZR	3
9/16"	24"	29"	47009	6
5/8"	24"	29"	47010	6
11/16"	24"	29"	47011	6
3/4"	24"	29"	47012	6
13/16"	24"	29"	47013	6
7/8"	24"	29"	47014	6
15/16"	24"	29"	47015	3
1"	24"	29"	47016	3
1-1/16"	24"	29"	47017	3



48715



Ship Auger Bits – Impact Shank

- Hex shank design for use in impact wrench drills
- Bit can be resharpened
- Medium-fast screw point ideal for general wood drilling applications

Diameter	Shank Size	Twist Length	Overall Length	Bulk Item #
1/2"	7/16"	9"	12"	48508
9/16"	7/16"	9"	12"	48509
11/16"	7/16"	9"	12"	48511
13/16"	7/16"	9"	12"	48513
9/16"	5/8"	9"	12"	48609ZR
9/16"	7/16"	15"	18"	48709
11/16"	7/16"	15"	18"	48711
13/16"	7/16"	15"	18"	48713
15/16"	7/16"	15"	18"	48715
1-1/16"	7/16"	15"	18"	48717



47811



1/2" Female Square Socket Impact Wrench – 51S18 Series

- Quick release button on the shank
- Medium-fast screw point is ideal for general wood drilling applications

Diameter	Twist Length	Overall Length	Bulk Item #
13/16"	15"	18"	47811



49916



Solid Center Auger with Cutting Spur – I-100 Series

- Solid center design provides extra rigidity while drilling
- Wide lands keep the bit straight as it bores through the hole. The flutes are ground behind the lands to funnel chips to the inside of the bit and away from the outside diameter, producing a faster, cleaner cut
- Single-spur cutting edge scribes the circumference of the hole for a smoother finish
- Coarse screw point provides fast drilling in hard and soft woods
- Full-length heat-treated bit guards against bending in heavy-duty applications, and strengthens the twist where the greatest strain occurs

Diameter	Shank Size	Twist Length	Overall Length	Bulk Item #	Pack Qty
1/4"	3/16"	4-1/2"	7-1/2"	49904	1
5/16"	7/32"	4-1/2"	7-1/2"	49905	1
3/8"	5/16"	4-1/2"	7-1/2"	49906	1
7/16"	5/16"	4-1/2"	7-1/2"	49907	1
1/2"	5/16"	4-1/2"	7-1/2"	49908	1
9/16"	5/16"	4-1/2"	7-1/2"	49909	1
5/8"	5/16"	4-1/2"	7-1/2"	49910	1
11/16"	5/16"	4-1/2"	7-1/2"	49911	1
3/4"	5/16"	4-1/2"	7-1/2"	49912	1
13/16"	5/16"	4-1/2"	7-1/2"	49913	1
7/8"	5/16"	4-1/2"	7-1/2"	49914	1
15/16"	5/16"	4-1/2"	7-1/2"	49915	1
1"	5/16"	4-1/2"	7-1/2"	49916	1
1-1/8"	7/16"	4-1/2"	7-1/2"	49918	1
1-1/4"	7/16"	4-1/2"	7-1/2"	49920	1
1-3/8"	7/16"	4-1/2"	7-1/2"	49922	1
1-1/2"	7/16"	4-1/2"	7-1/2"	49924	1

Solid Center Auger Bit Sets

6-pc pouched contains 1/4", 3/8", 1/2", 5/8", 3/4" & 1"	49998	1
3-pc pouched contains 1/4", 3/8", & 1/2"	49999	6



45516



Drilling Machine Auger Bits – 62R Series, 1/2" Round Shank

- Round shank is designed for use in power drills, drill presses, and drilling machines with 1/2" or larger chuck
- Heavy stem increases strength and rigidity while reducing vibration. Shank length is 2".
- Medium-fast screw point is ideal for general wood drilling applications

Diameter	Twist Length	Overall Length	Bulk Item #
7/16"	6"	8"	45307
1/2"	6"	8"	45308
9/16"	6"	8"	45309
11/16"	6"	8"	45311
3/4"	6"	8"	45312
13/16"	6"	8"	45313
7/8"	6"	8"	45314
1"	6"	8"	45316
3/8"	8"	10"	45406
7/16"	8"	10"	45407
9/16"	8"	10"	45409
11/16"	8"	10"	45411
3/4"	8"	10"	45412
13/16"	10"	12"	45513
1"	10"	12"	45516
3/8"	12"	14"	45606
1/2"	12"	14"	45608
11/16"	12"	14"	45611
3/4"	12"	14"	45612
13/16"	12"	14"	45613
7/8"	12"	14"	45614
1"	12"	14"	45616



43616

Hand Brace Solid Center Auger Bits – 62T Series

- Medium-fast screw point is ideal for general wood drilling applications
- Full-length heat-treated bit guards against bending in heavy-duty applications, and strengthens the twist where the greatest strain occurs
- Double spur, double cutter design leaves an extremely clean hole finish

Diameter	Shank Type	Twist Length	Overall Length	Pouched Item #	Bulk Item #
1/4"	Taper square	3-1/2"	7-1/2"	43604	-
5/16"	Taper square	3-5/8"	7-5/8"	43605	-
3/8"	Taper square	3-3/4"	7-3/4"	43606	-
7/16"	Taper square	3-7/8"	7-7/8"	43607	-
1/2"	Taper square	4"	8"	43608	-
9/16"	Taper square	4-1/8"	8-1/8"	43609	-
5/8"	Taper square	4-1/4"	8-1/4"	43610ZR	-
11/16"	Taper square	4-3/8"	8-3/8"	43611	-
3/4"	Taper square	4-1/2"	8-1/2"	43612	-
13/16"	Taper square	4-5/8"	8-5/8"	43613ZR	-
7/8"	Taper square	4-9/16"	8-3/4"	43614	-
15/16"	Taper square	4-11/16"	8-7/8"	43615	-
1"	Taper square	4-13/16"	9"	43616	-
1-1/2"	Taper square	4-7/8"	9-1/2"	-	43624
13-pc Pouch	-	-	-	-	43697

WOOD DRILLING

Wood Drilling

Installer / Adjustable Wood Bits



38912

Wood Installer Bits

- Constructed of premium alloy steel for drilling into a variety of materials including wood, plaster, and metal lath encountered while installing wire
- Special 82° point for fast drilling
- Hole in flute makes it easy to pull wire through walls, ceilings, and floors
- Ideal for installation of small wire for telephones, cable TV, computers, and security systems

Diameter	Shank Size	Overall Length	Item #	Bulk Item #
1/4"	.230"	12"	–	38904
5/16"	.285"	12"	–	38905
3/8"	.370"	12"	–	38906
1/2"	.370"	12"	–	38908
9/16"	.370"	12"	–	38909
5/8"	.370"	12"	–	38910
3/4"	.370"	12"	–	38912
1/4"	.230"	18"	39104	39004
5/16"	.285"	18"	39105	39005
3/8"	.370"	18"	39106	39006
7/16"	.370"	18"	39107ZR	39007
1/2"	.370"	18"	39108ZR	39008
9/16"	.370"	18"	39109ZR	–
5/8"	.370"	18"	39110	39010
11/16"	.370"	18"	39111	–
3/4"	.370"	18"	39112	–
1/4"	.230"	24"	–	39404
5/16"	.285"	24"	–	39405
3/8"	.370"	24"	–	39406
1/2"	.370"	24"	–	39408
1/4"	.230"	30"	–	39604
3/8"	.370"	30"	–	39606
1/2"	.370"	30"	–	39608
Installer Bit Sets				
3-pc Set 1/4", 3/8", 1/2"			–	3044001LW

WOOD DRILLING



40012

Masonry Installer Bits

- Hole in flute makes it easy to pull wire through walls, ceilings, and floors
- Specially designed flute quickly clears masonry dust
- Heavy duty 118° point enters material quickly
- Carbide tip cutting edge ideal for use where masonry construction is encountered including brick, mortar joints, and cinder blocks

Diameter	Shank Size	Overall Length	Item #
1/4"	.245"	18"	40004ZR
5/16"	.250"	18"	40005
3/8"	.370"	18"	40006
1/2"	.370"	18"	40008
5/8"	.370"	18"	40010
3/4"	.370"	18"	40012



45002

Adjustable Wood Bits

- Adjustable cutting blade bores a variety of hole sizes
- Cuts 19 hole sizes in increments of 1/8"
- Lockhead screw securely holds blade at desired drilling diameter

Diameter	Shank Size	Usage	Overall Length	Item #
5/8" - 1-3/4"	9/32"	Drill Press	5-1/2"	44801
7/8" - 3"	11/32"	Drill Press	6-1/2"	45002
7/8" - 3"	–	Hand Brace	–	44202

SPEEDBOR MAX SELF-FEED BIT FEATURES

1. Aggressive screw pitch for faster drilling
2. 3X cutting edges* extends bit life
3. 7/16" Quick Change impact shank for fast bit changes



SPEEDBOR Max Self-Feed Wood Bits

- For drilling large diameter holes in wood for pipe, conduit and other applications
- Precision-milled shank eliminates runout and wobble
- Replaceable screw tip
- Resharpenable edges

*2 cutting edges on sizes 3" and larger

Diameter	Overall Length	Pack Qty.	Item #
1"	5"	1	3046004
1-1/8"	5"	1	3046005
1-1/4"	5"	1	3046006
1-3/8"	5"	1	3046007
1-1/2"	5"	1	3046008
1-3/4"	5"	1	3046009
2"	5"	1	3046010
2-1/8"	5"	1	3046011
2-1/4"	5"	1	3046012
2-9/16"	5"	1	3046013
3"	5"	1	3046014
3-5/8"	5"	1	3046015
4-5/8"	5"	1	3046016

Lock-n-Load® Quick Change Extensions

7/16" Quick Change Bit Holder 5-1/2" OAL	3	4935654
7/16" Quick Change Bit Holder 12" OAL	3	4935655
7/16" Quick Change Bit Holder 18" OAL	3	4935656



49618

Brad Point Drill Bits & Sets

- Brad point tip provides accurate positioning for starting the hole
- Bit is precision-ground for use in furniture making, doweling, cabinetry, and other woodworking applications where an exact hole size is required
- Spur cutting edges reduce splintering and ensure a smooth, clean hole
- Wide flutes provide a fast, continuous flow of chip ejection

Diameter	Shank Size	Twist Length	Overall Length	Item #
1/8"	1/8"	1-7/16"	2-9/16"	49612
3/16"	3/16"	2-1/16"	3-3/8"	49613
1/4"	1/4"	2-1/2"	3-31/32"	49614
5/16"	5/16"	2-15/16"	4-19/32"	49615
3/8"	3/8"	3-7/16"	5-1/4"	49616
7/16"	3/8"	3-11/16"	5-19/32"	49617
1/2"	3/8"	3-31/32"	5-15/16"	49618

Brad Point Drill Bit Set

5-pc pouched set contains 3/16", 1/4", 5/16", 3/8" & 1/2" 49600

Wood Drilling

Forstner Bits / Plug Cutters / Countersinks

Forstner Bits



42916

- Reduced shank fits 3/8" portable drills and drill presses
- Brad point tip starts the bit cleanly on uneven surfaces

Forstner Bit Set



42940

Diameter	Shank Size	Item #
1/4"	3/8"	42904
3/8"	3/8"	42906
1/2"	3/8"	42908
5/8"	3/8"	42910
3/4"	3/8"	42912
7/8"	3/8"	42914
1"	3/8"	42916
1-1/8"	3/8"	42918
1-1/4"	3/8"	42920
1-3/8"	3/8"	42922
1-1/2"	3/8"	42924
1-5/8"	3/8"	42926
1-3/4"	3/8"	42928
1-7/8"	3/8"	42930
2"	3/8"	42932
2-1/8"	3/8"	42934
4" Extension	3/8"	42936
Forstner Bit Set		
4-pc Set contains 5/8", 3/4", 7/8", 1"		42940

WOOD DRILLING

Plug Cutters



43910

- Recommended for covering fastener holes in furniture, cabinetry, floors, decks, and other woodworking projects
- Constructed of hardened, high-carbon steel for added strength and durability
- Ideal for making dowels

Diameter	Shank Size	Item #
1/4"	1/4"	43904
3/8"	1/4"	43906
1/2"	1/4"	43908
5/8"	1/4"	43910

Adjustable Countersinks



90583

Description	Counterbore Diameter	Drill Bit Size	Item #
#4 - 5 Countersink	3/8"	5/64"	90581
#6 - 7 Countersink	3/8"	3/32"	90582
#8 - 9 Countersink	3/8"	7/64"	90583
#10 Countersink	3/8"	1/8"	90584
#12 Countersink	1/2"	9/64"	90585