

Valve Selection Guide

SAFETY

Ball Valve

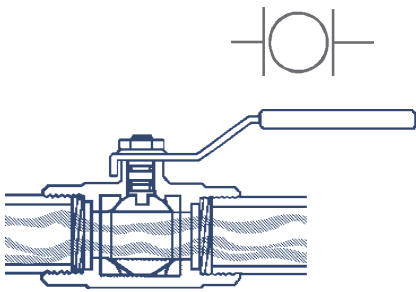

- Can be used for on and off service or throttling
- When positive shut-off is necessary
- Where a low valve profile is necessary
- Only 90° rotation from open to fully closed (quick opening)
- Handle position is a quick indication of whether valve is open or closed.
- Full port ball valves do not resist flow

Butterfly Valve

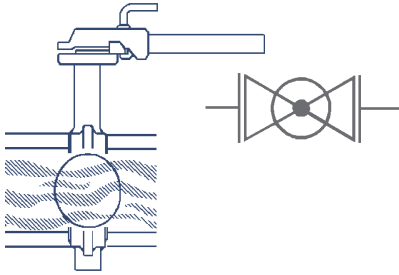

- Where positive shut-off is necessary
- Primarily for fully open or fully closed applications
- May be used for throttling
- Only 90° rotation from open to fully closed
- Lightweight
- Easy to install
- Less costly than an Iron body gate valve

Gate Valve

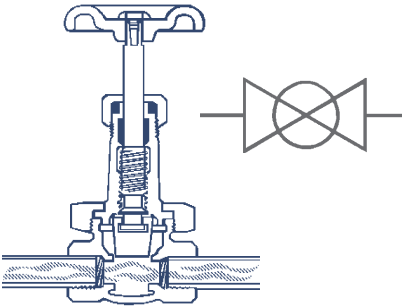

- For fully open or fully closed service, *not for throttling*
- For minimum line pressure drop
- For minimum fluid entrapment in the line
- For relatively infrequent operation

Check Valve

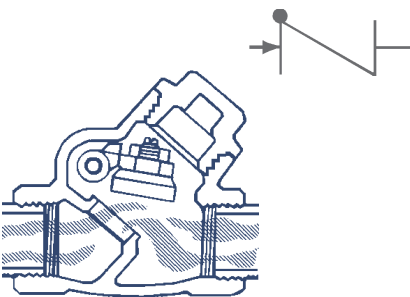

- To control the direction of flow and for quick, automatic reactions to flow change. Swing check valves are used when a minimum resistance to flow is required.
- Swing check valves are recommended for use in conjunction with gate valves. They should not be used in a rapid recycling system such as reciprocating pumps or air compressor service where they could cause chatter and damaging vibration.

Globe Valve

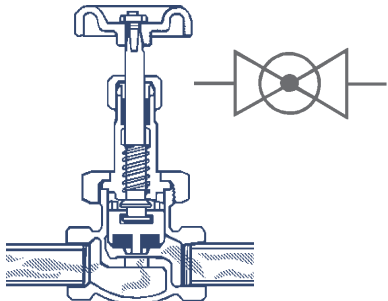

- For regulation (throttling) of flow
- For frequent operation; short stem travel reduces operator's time.
- Where some line resistance is acceptable

Dixon's couplings and retention devices are designed to work safely for their intended use. The selection of the proper hose, coupling and retention device, and the proper application of the coupling to the hose are of utmost importance.

Users must consider the size, temperature, application, media, pressure and hose and coupling manufacturer's recommendations when selecting the proper hose assembly components. Dixon recommends that all hose assemblies be tested in accordance with the Association for Rubber Products Manufacturer's (ARPM) recommendations and be inspected regularly (before each use) to ensure that they are not damaged or have become loose. Visit ARPMINC.com for more information.

Where safety devices are integral to the coupling, they must be working and utilized. The use of supplementary safety devices such as safety clips or safety cables are recommended.

If any problem is detected, couplings must be removed from service immediately.

Dixon is available to consult, train and recommend the proper selection and application of all fittings we sell. We strongly recommend that distributors and end users make use of Dixon's Testing and Recommendation Services. Call 877.963.4966 or click dixonvalve.com to learn more.

Full Flow Aluminum Ball Valves

Materials:

- wetted parts are aluminum and stainless steel
- FPM seals

Features:

- high flow rate; low pressure drop
- spindle can be disassembled even when ball valve is installed
- one way and two way configurations available

Specifications:

- working pressure: **150 PSI** at ambient temperature (70°F)
- standard valve ports - female NPT, socket weld for Schedule 40 pipe and grooved
- optional ports include DN flange, butt weld and 150# flange, contact Dixon® for details



one way, grooved



two way, female NPT

Domestic Bronze Ball Valves

Female NPT x Female NPT

Application:

- for control of air, water, oil and gas in hose or pipe lines, for other services, please contact Dixon®

Sizes:

- 1/4" - 1/2" available in full port design (*BBV··*)
- 3/4" - 3" available in standard port design (*BBV···*)

Materials:

- bronze valve bodies, balls and stems
- glass-filled reinforced PTFE seats and stuffing box ring; stem seals and washers
- plated steel handles and nuts with vinyl sleeves replacements available, consult Dixon® for pricing

Features:

- blow-out proof stems
- full and standard port valves are repairable
- meets WW-V 35C, Type II Composition

Specifications:

- pressure rating: **600 PSI** WOG; **150 PSI** saturated steam

Approvals:

- meets WW-V 35C, Type II Composition



Locking Handle Bronze Ball Valves

Female NPT x Female NPT

Application:

- for control of air, water, oil and gas in hose or pipe lines, for other services, please contact Dixon®

Sizes:

- 1/4" - 1/2" available in full port design (*BBLV··*)
- 3/4" - 2" available in standard port design (*BBLV···*)

Materials:

- chrome-plated bronze ball
- plated steel handles and nuts with vinyl sleeves

Features:

- blow-out proof RPTFE stem
- Stainless steel sliding lock mechanism secures handle in open or closed position; can be padlocked opened or closed.
- full and standard port valves are repairable

Specifications:

- pressure rating: **600 PSI** WOG; **150 PSI** saturated steam

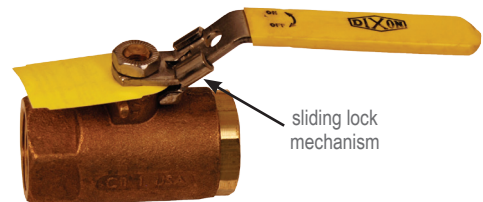

Imported Brass Ball Valves

Female NPT x Female NPT



Applications:

- for control of air, water, oil and gas in hose or pipe lines, for other services, please contact Dixon®

Sizes:

- ¼" - 4" available in full port design (*FBV*·, *FBV*··)

Materials:

- forged brass body
- PTFE seat, seal and thrust washer
- chrome-plated brass ball and plated steel handle

Feature:

- blow-out proof stems

Specifications:

- pressure rating: **600 PSI** WOG; **150 PSI** Working Steam Pressure
- maximum temperature: **366°F**

Approval:

- Underwriters Listed

Global Brass Ball Valves

Female NPT x Female NPT

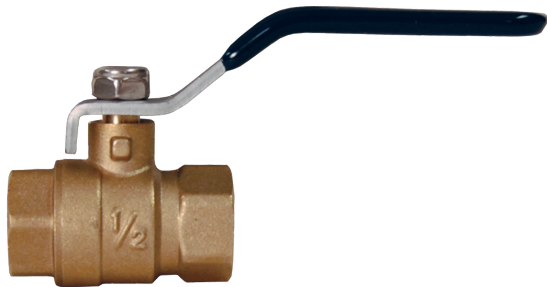

Applications:

- *for water and air only*

Sizes:

- ¼" - 2" available in full port design (*FBVG*·, *FBVG*··)

Material:

- forged brass body

Specifications:

- pressure ratings:
 - ¼" - ¾" rated to **365 PSI**
 - ½" - 2" rated to **600 PSI**
- maximum temperature: **248°F** (120°C)

Lead Free Brass Ball Valves

Female NPT x Female NPT



Sizes:

- ½" - 2" available in full port design (*LFV*·, *LFV*··)

Materials:

- PTFE seat and double O-ring stem packing

Features:

- lead free refers to the wetted surface of pipes, fittings and fixtures in potable water systems that have a weighted average lead content = 0.25%. Source: California Health & Safety Code (116875). Vermont Act 193*171NLF

Specifications:

- pressure rating: 600 WOG - 150 WSP
- maximum temperature: **366°F**

Brass Mini Ball Valves



Female NPT x Female NPT

Sizes:

- 1/8" - 1/2" available in standard port design (*MBV··*)

Materials:

- nickel plated brass body
- PTFE seats and FKM stem seal

Feature:

- blow-out proof stem

Specifications:

- pressure rating: **450 PSI**
- maximum temperature **330°F**

Approval:

- Canadian Standard Association approved

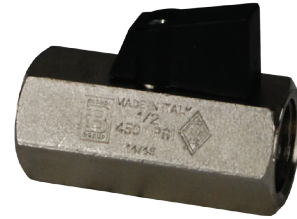

Brass Safety Vented Ball Valves

Female NPT x Female NPT

Application:

- for air service only

Sizes:

- 1/4" - 1/2" available in full port design (*BBV·LV*)
- 3/4" - 2" available in standard port design (*BBV·LV, BBV··LV*)

Materials:

- bronze valve
- chromium plated ball
- RTFE seats and stuffing box ring

Features:

- blow-out proof stem design
- adjustable packing gland

Specification:

- pressure rating: **600 PSI**

Approval:

- vent downstream air in accordance with OSHA regulation 1910.147 for pneumatic systems

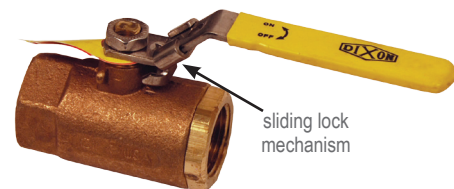

"Deadman" Spring Return Handle Bronze Ball Valves

Female NPT x Female NPT

Sizes:

- 1/2" available in full port design (*BBV·SR*)
- 3/4" - 2" available in standard port design (*BBV·SR, BBV··SR*)

Materials:

- stainless steel lever
- chromium plated ball
- RTFE seats and stuffing box ring

Features:

- vacuum service to 29 inches Hg
- blow-out proof stem design
- adjustable packing gland
- spring return closes valve when not held open
- operating torque approximately three times standard valve torque
- RTFE seats and stuffing box ring

Specification:

- pressure rating: **600 PSI WOG; 150 PSI saturated steam**



Bronze Ball Valves with NPT Tap for Drain

Female NPT x Female NPT

Applications:

- recommended for water and air service

Sizes:

- ¼" - 1" available in full port design (*BBV·VT, BBV··VT*)

Materials:

- chromium plated ball
- RTFE seats and stuffing box ring

Features:

- vent downstream air in accordance with OSHA regulations for pneumatic systems
- blow-out proof stem
- adjustable packing gland
- auto-drain / auto-vent

Specifications:

- pressure rating: **125 PSI WOG**
- ¼" NPT tapped port provides additional options such as an air venting elbow or noise muffler



3-Way Diversion Ball Valves

Female NPT x Female NPT x Female NPT - L Flow Pattern



Bronze Valves

Sizes:

- ½" available in full port design (*BBV·TW*)
- ¾" - 1" available in standard port design (*BBV·TW, BBV··TW*)

Materials:

- bronze body
- chromium-plated ball
- RPTFE seats and stuffing box ring
- stainless steel handle and nut with vinyl sleeve

Features:

- can be used with gasoline and diesel fuel
- blow-out proof stem
- adjustable packing gland

Specifications:

- pressure rating: **400 PSI WOG**

Stainless Steel Valves

Sizes:

- ½" - 1" available in full port design (*SSBV·TW*)
- ¾" - 1" available in standard port design (*SSBV·TW, SSBV··TW*)

Materials:

- stainless steel body and ball
- RPTFE seats and stuffing box ring
- stainless steel handle and nut with vinyl sleeve

Features:

- blow-out proof stem
- adjustable packing gland

Specifications:

- rated to **800 PSI WOG**

Approvals:

- meets NACE MR-01-75

Brass 3-Way Diverting Ball Valves

Female NPT x Female NPT x Female NPT - T Flow Pattern

Sizes:

- ½" - 2" available in standard port design (*BBV·DTW, BBV··DTW*)

Materials:

- brass body
- chrome plated brass ball
- PTFE seats, seals, and thrust washer

Features:

- blow-out proof stem
- adjustable stem packing

Specifications:

- pressure rating: **400 PSI WOG**; **100 PSI** saturated steam
- maximum temperature: **366°F**



Domestic Full Port Ball Valves

Female NPT x Female NPT

Sizes:

- ¾" - 2" available in full port design (*BBV·FP, BBV··FP*)

Materials:

- machined solid chrome-plated ball
- multi-fill PTFE seats and seals
- bronze castings

Features:

- adjustable packing
- blow-out proof stem design
- vacuum service to 29 inches Hg

Specification:

- pressure rating: **600 PSI** WOG; **150 PSI** saturated steam



250 Lb. Steam Ball Valves

Female NPT x Female NPT

Application:

- recommended for use with fluids with widely varying temperatures and/or thermal expansion rates

Sizes:

- ½" available in full port design (*BBV·ST*)
- ¾" - 2" available in standard port design (*BBV·ST, BBV··ST*)

Materials:

- bronze body
- 316 stainless steel ball and stem
- multi-fill RPTFE seats

Features:

- vacuum service to 29 inches Hg
- blow-out proof stem design
- multi-fill stuffing box ring
- high temperature MTFE stem packing
- adjustable packing gland

Specifications:

- pressure rating: **600 PSI**; **250 PSI** saturated steam
- maximum temperature: **450°F**



Carbon Steel Ball Valves

Female NPT x Female NPT

Applications:

- for control of air, water, oil and gas in hose or pipe lines, for other services, please contact Dixon®

Sizes:

- ¼" - ¾" available in full port design (*IBV··*)
- ½" - 2" available in standard port design (*IBV··, IBV···*)

Materials:

- carbon steel body
- chromium plated ball
- RPTFE seat and seal

Features:

- blow-out proof stem
- adjustable packing gland

Specifications:

- pressure rating: **150 PSI** saturated steam
¼" - 1" rated to **2000 PSI**
1¼" - 2" rated to **1500 PSI**



High Pressure Full-Bore Ball Valves

Female NPT x Female NPT



Sizes:

- Carbon steel 1/4" - 2" (*HPBV·, HPBV·, HPBV·SAE, HPBV·SAE*)
- 316 stainless steel 1/4" - 1" (*HPBV·SS, HPBV·SS*)

Materials:

- FKM / FPM seals
- POM (Polyacetal) ball seats

Features:

- blow-out proof stem
- rugged construction

Brass Dual Y Valves

Female NPT x Female NPT

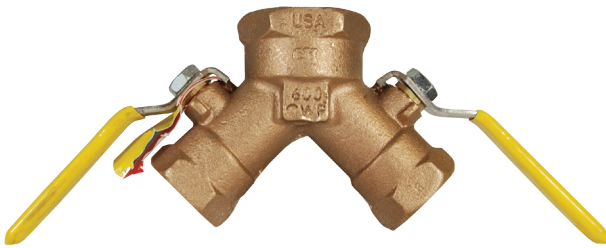

Application:

- dual action valve, ideal for compressor applications

Sizes:

- 1" and 1 1/4" available in non-vented and vented flow

Feature:

- Non-vented (*BBV·DW*) and vented (*BBV·DWV*)

Specifications:

- non-vented pressure rating: **600 PSI** WOG
- vented pressure rating: **125 PSI** Cold Working Pressure

Stainless Steel Ball Valves

Female NPT x Female NPT



Application:

- for use with water, oil and gas

Sizes:

- 1/4" - 3" available in full port design (*SSBV·, SSBV·*)

Materials:

- 316 stainless steel body, ball and stem
- R-PTFE seat, joint gasket and thrust washer
- plastic cover on handle

Feature:

- blow-out proof stem design

Specifications:

- pressure rating: 1/4" - 2" rated to **1000 PSI** WOG (CWP)
2 1/2" - 3" rated to **800 PSI** WOG (CWP)
100 PSI saturated steam
- temperature range: **-20°F to 450°F**

Stainless Steel Locking Handle Ball Valves

Female NPT x Female NPT - Full Port

Applications:

- for use with water, oil and gas

Sizes:

- ¼" - 3" available in full port design (*SSLBV*·, *SSLBV*···)

Materials:

- 316 stainless steel body, ball and stem
- R-PTFE seat, joint gasket and thrust washer
- plastic cover on handle

Features:

- blow-out proof stem design
- lockable

Specifications:

- pressure rating: ¼" - 2" rated to **1000 PSI** WOG (CWP)
2½" - 3" rated to **800 PSI** WOG (CWP)
100 PSI saturated steam
- temperature range: **-20°F to 450°F**

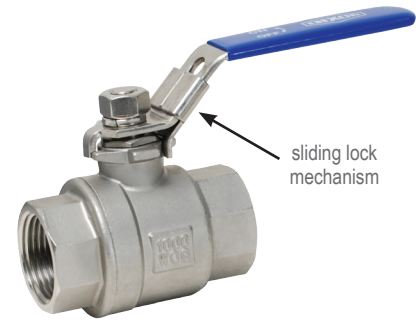

Female NPT x Female NPT - Reduced Port

Applications:

- for use with water, oil and gas

Sizes:

- ¼" - 2" available in reduced port design (*SSLBV*··*SP*, *SSLBV*···*SP*)

Materials:

- 316 stainless steel body, ball and stem
- R-PTFE seat, joint gasket and thrust washer
- plastic cover on handle

Features:

- blow-out proof stem design
- lockable

Specifications:

- pressure rating: **800 PSI** WOG; **100 PSI** saturated steam
- temperature range: **-20°F to 450°F**

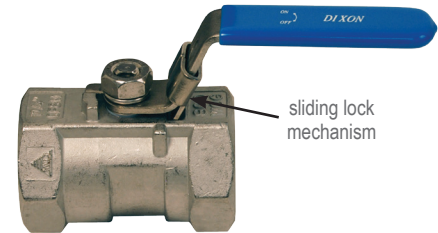

Pneumatically Actuated 3-Piece Stainless Ball Valves

Full Port
Female NPT x Female NPT

Materials:

- 15% glass reinforced RTFE seats
- blow-out proof stainless steel stem

Features:

- live-loaded stem packing
- ISO 5211 mounting pad
- swing out in-line easy maintenance

Specifications:

- temperature range: ½" to 2" **-40°F to 350°F**,
3" to 4": -40°F to 325°F
- pressure rating: ½" - 2" **1000 PSI** WOG
3" **800 PSI** WOG

Rack and Pinion Actuator

Materials:

- hard anodized aluminum body
- Buna-N O-rings
- nickel plated anti-blowout pinion

Features:

- NAMUR mounting
- visual position indication
- tested to one million cycles

Specifications:

- maximum operating pressure: **120 PSI**
- temperature range: **-40°F to 200°F**
- bi-directional stops for $\pm 5^\circ$ travel adjustment
- **80 PSI** plant air required



Pneumatically Actuated 2-Piece Ball Valves

Direct Mount - Full Port
Female NPT x Female NPT

Rack and Pinion Actuator

Materials:

- hard anodized aluminum body
- nickel plated anti-blowout pinion
- Buna-N O-rings

Features:

- NAMUR mounting
- visual position indication
- tested to one million cycles

Specifications:

- bi-directional stops for $\pm 5^\circ$ travel adjustment
- **80 PSI** plant air required
- maximum operating pressure: **120 PSI**
- temperature range: **-40°F to 200°F**



2-Piece Stainless Ball Valve

Materials:

- RTFE seats and seals

Features:

- blow-out proof stem
- live-loaded stem packing
- ISO 5211 mounting pad

Specifications:

- pressure rating: 1/4" - 2" **1000 PSI WOG**, 2 1/2" - 3" **800 PSI WOG**
- temperature range: 1/4" to 2": **-40°F to 350°F**,
2 1/2" to 3": **-40°F to 325°F**



2-Piece Brass Ball Valve

Materials:

- brass, body and ball
- FKM elastomers
- blow-out proof brass stem
- PTFE seats with double O-ring stem packing

Features:

- ISO 5211 mounting pad

Specifications:

- pressure rating: - **600 PSI WOG**
- **150 PSI WSP**
- maximum temperature: **300°F**

Pneumatically Actuated 3-Way T/L Port Ball Valves

Direct Mount - Standard Port
Female NPT x Female NPT

Rack and Pinion Actuator

Materials:

- hard anodized aluminum body
- nickel plated anti-blowout pinion
- Buna-N O-rings

Features:

- NAMUR mounting
- visual position indication
- tested to one million cycles

Specifications:

- bi-directional stops for $\pm 5^\circ$ travel adjustment
- **80 PSI** plant air required
- maximum operating pressure: **120 PSI**
- temperature range: **-40°F to 200°F**

3-Way Stainless Ball Valve

Features:

- full port
- blow-out proof stem
- live-loaded stem packing
- ISO 5211 mounting pad

Specifications:

- female NPT ends
- 100% air tested under water at **80 PSI**
- working pressure: $\frac{1}{4}$ " to 1": **1000 PSI**;
1 $\frac{1}{4}$ " to 2": **800 PSI**
- maximum temperature: **300°F**



3-Way Brass Ball Valve

Materials:

- brass body and chrome-plated brass ball
- PTFE seats with O-ring backing for low operating torque
- PTFE seats and double O-ring stem packing

Features:

- reduced port
- blow-out proof stem
- ISO 5211 mounting pad
- 100% tested

Specifications:

- pressure rating: **400 PSI WOG 100 PSI WSP**
- maximum temperature: **300°F**

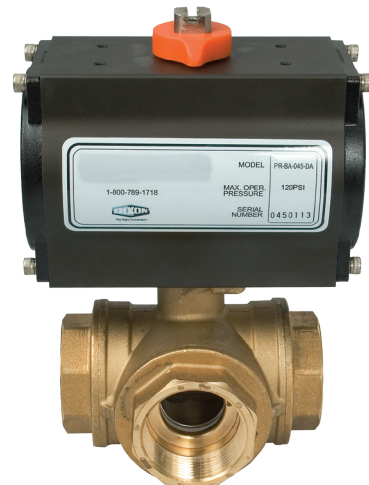

Electrically Actuated Ball Valves

Female NPT x Female NPT

Electric Actuator

Sizes:

- manual override standard: 1/2" - 1 1/2"

Materials:

- lightweight powder coated aluminum alloy housing
- high alloy steel gear train

Features:

- NEMA 4/4X waterproof and dustproof
- extended duty cycle induction motor
- H-insulation class
- visual position indication
- space heater is standard

Specification:

- temperature range: -41°F to 140°F

Approvals:

- ISO 9001, CS, CE and CSA-C US Certified
- RoHS compliant



3-Piece Stainless Ball Valve

Materials:

- 15% glass reinforced RTFE seats
- blow-out proof stainless steel stem

Features:

- 3-Piece
- live-loaded stem packing
- ISO 5211 mounting pad
- swing out in-line easy maintenance

Specifications:

- pressure rating: 1/2" - 2" **1000 PSI WOG**
3" **800 PSI WOG**
- temperature range: 1/2" to 2": **-40°F to 350°F**
3" to 4": **-40°F to 325°F**



2-Piece Brass Ball Valve

Materials:

- brass, body and ball
- FKM elastomers
- blow-out proof brass stem
- PTFE seats with double O-ring stem packing

Features:

- ISO 5211 mounting pad

Specifications:

- pressure rating: - **600 PSI WOG**
- **150 PSI WSP**
- maximum temperature: **300°F**

Actuated Valve Accessories

Solenoids

Material:

- electroless nickel plated spool

Features:

- duty cycle: 100% extended duty
- easy-to-use manual override
- NEMA 4 4/X Enclosure
 - water and dust tight for indoor or outdoor use
 - corrosion resistant

Specifications:

- pressure range: **30 PSI to 150 PSI**
- voltages available: 12VDC, 24VDC, 24VAC, 48VAC, 110VAC, 220VAC
- port sizes: inlet and exhaust 1/4" NPT



Limit Switches

Features:

- visual position indicator
- 3D open/close indication
- quick-set cam
- mechanical SPDT switches (standard)
- multipoint terminal strip
- various switch options available

Enclosures available:

NEMA 4 4/X

- water and dust tight for indoor or outdoor use
- corrosion resistant

NEMA 7

- water and dust tight for indoor or outdoor use
- corrosion resistant
- for use in indoor hazardous locations
- explosion proof

Specification:

- cable entry: (2) 1/2" NPT



Positioners

Specifications:

- air capacity:
 - at **29 PSI** (200kPa): 9.5 SCFM
 - at **87 PSI** (600kPa): 28.3 SCFM
 - at **145 PSI** (1MPa): 47.1 SCFM
- air connections: 1/4" NPT
- gauges: 1/8" NPT
- cable entry: 1/2" NPT

Electro-Pneumatic

- input range: 4-20mA (Ri<250ohms)
- supply pressure: **21.8 to 145 PSI** (0.15 to 1MPa)
- linearity error: <1.0% f.s
- hysteresis: <0.6% f.s
- repeatability: <0.5% f.s

Pneumatic

- input range: **3 to 15 PSI** (20-100kPa)
- supply pressure: **< 145 PSI** (<1MPa)
- linearity error: <0.7% f.s
- hysteresis: <0.4% f.s
- repeatability: <0.3% f.s



Ductile Iron Butterfly Valves



NOT RECOMMENDED FOR STEAM SERVICE

- for use between two 150 lb. flanges
- 10 position trigger grip handle
- pressure rating: **200 PSI** at ambient temperature (70°F)

Threaded Lug Style



Sizes:

- 2" - 6" available, (*BFVL...*)

Materials:

- ductile iron body, ASTM A536
- aluminum bronze disc, ASTM B148, ALY.954
- PTFE bushing
- stainless steel top and bottom stems

Wafer Style



Sizes:

- 2" - 6" available, (*BBFVW...*)

Features:

- ductile iron body, ASTM A536
- aluminum bronze disc, ASTM B148, ALY.954
- PTFE bushing
- stainless steel top and bottom stems



Sizes:

- 2" - 6" available, (*BFVW...*)

Features:

- ductile iron body, ASTM A536
- stainless steel disc, ASTM A351, GR. CF-8M
- PTFE bushing
- stainless steel top and bottom stems



Sizes:

- 3" - 6" available, (*IBFVW...*)

Features:

- ductile iron body, ASTM A536
- nickel plated ductile iron disc
- Buna-N seal and stem seals
- PTFE bushing
- 416 stainless stem

Steel Flow Control Valves

Series MV

Sizes:

- 1/4" - 1/2" available, (*SMV...*)

Material:

- 416 stainless steel needle

Features:

- easily make fine adjustments and resets with color code feature that shows when desired setting is reached
- body components are precision-turned from solid barstock

Specification:

- maximum operating pressure: **5000 PSI** at 70°F



Brass Needle Valves

NPT x NPT

Applications:

- designed for air and water

Sizes:

- 1/8" and 1/4" available, (*NV-F, NV-M*)

Feature:

- metal-to-metal seats allow positive sealing and flow adjustment

Specification:

- maximum working pressure: **150 PSI** at ambient temperature (70°F)

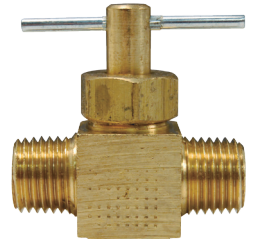
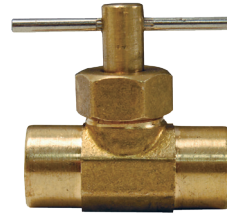

Mini Needle Valves

NPT x NPT

Sizes:

- 1/8" and 1/4" are orifice size: 0.172", flow coefficient: 0.42
- 1/2": orifice size are 0.187", flow coefficient: 0.44
- 1/8" and 1/4" available with knurled knob, brass (*MFB...*, *FFB...*)
- 1/8" and 1/2" available with T design handles, nickel plated steel (*MFC...*, *FFC...*)
- 1/8" and 1/2" available with T design handles, 316 stainless steel (*MFS...*, *FFS...*)

Materials:

- available in a variety of materials and handle options
- FKM O-ring seal and PTFE back-up ring below the threads protects from corrosion and galling

Features:

- stem threads are rolled for strength and ease of operation
- metal-to-metal hard seat design is 100% helium leak tested to 1 x 10⁻⁴ ml/s at **200 PSI**

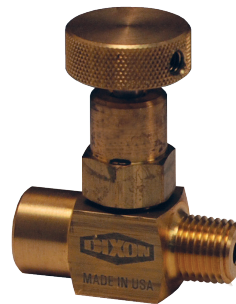

Domestic Gate Valves

Female NPT x Female NPT



Sizes:

- ½" - 2" available (*DBGV*·, *DBGV*··)

Material:

- malleable iron handwheel

Features:

- Class 150
- union bonnet
- ASME B1.20.1
- Grafoil® packing
- rising stem
- solid disc
- 100% factory tested

Specifications:

- pressure rating: **300 PSI** cold working pressure, **150 PSI** steam working pressure
- temperature range: -20°F to 406°F

Gate Valves

Female NPT

Sizes:

- ¼" - 4" available, brass (*BGV*·, *BGV*··),
- ½" - 2" available, 316 stainless steel (*SSGV*·, *SSGV*··)

Material:

- iron handwheel

Features:

- threaded bonnet
- integral seat
- adjustable packing nut
- non-rising stem
- solid wedge disc
- 100% factory tested

Specifications:

- pressure rating: **200 PSI** non-shock cold water, oil, gas



Female NPT

Application:

- can be used for steam service

Sizes:

- ½" - 2" available, forged steel (*FSGV*·, *FSGV*··)

Features:

- Class 800
- ASTM A105, ANSI B120.1
- bolted bonnet
- pressure rating: **1975 PSI**
- maximum temperature: **800°F**

Specifications:

- pressure rating: **1975 PSI**
- maximum temperature: **800°F**



Drum Plug Wrenches

Materials:

- bronze *DPW*, aluminum *ADPW*

Features:

- sparkproof, natural finish is safe around flammables
- offset handle design reduces user stress and minimizes knuckle injury



Compression Bibb Faucets

Male NPT

Application:

- for water use only

Size:

- 1/2" and 3/4" available (35-20--10)

Features:

- rough brass finish
- nozzle end is GHT



Drum Faucets

Polyethylene Drum Faucet

Sizes:

- 3/4" and 2" available (PEDF-, PEDF...)

Features:

- no wrench needed for screwing into drum opening
- 2" faucet is shipped with a gasket; the 3/4" does not require a gasket

Specifications:

- Faucets are *not* to be used in applications where temperatures exceed 140°F (60°C).

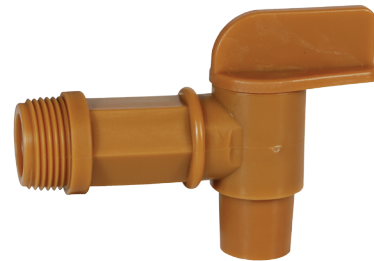

Stainless Heavy Duty Adjustable Drum Faucet

Materials:

- PTFE gasket

Features:

- adjustable shank is designed to easily adjust to proper drain position after installing in drum
- HDSSF-

Specification:

- 3/4" NPT connection

Approval:

- FM approved for use with oils and non-flammables

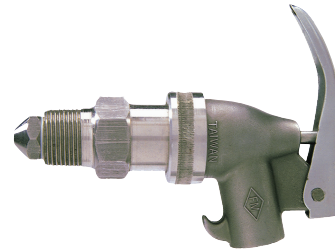

Brass Heavy Duty Adjustable Drum Faucet

Features:

- easy to use, self-closing design
- AHDBF-

Specification:

- 3/4" NPT connection

Approval:

- FM approved for use with oils and non-flammables

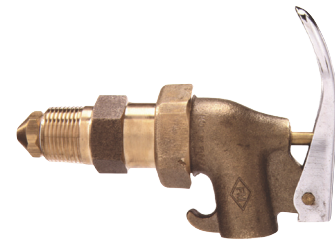

Brass Heavy Duty Drum Faucet with Rigid Shank

Material:

- PTFE gasket

Features:

- easy to use, self-closing design
- HDBF-

Specification:

- 3/4" NPT connection

Approval:

- FM approved for use with oils and non-flammables

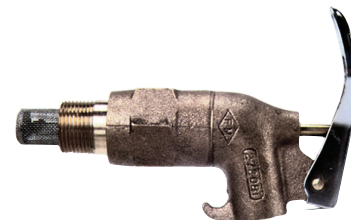

Polypropylene Single Union Ball Valves

Female NPT x Female NPT



Sizes:

- ½" - 3" available (*SUBV··*, *SUBV···*)

Materials:

- corrosion resistant polypropylene body, PTFE ball seat

Features:

- EPDM O-ring
- FDA approved material

Specification:

- pressure rating: **125 PSI** at 70°F

Polypropylene Bolted Ball Valves

Female NPT x Female NPT

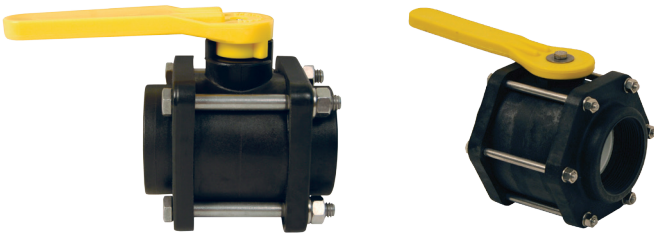

Sizes:

- ½" - 1½" available full port, 4-bolt (*PVFP··*, *PVFP···*)
- 1" - 2" available standard port, 4-bolt (*PV···*)
- 2" - 4" available full port, 6-bolt (*PVFP···*)

Materials:

- FDA approved material
- chemically-resistant, reinforced polypropylene body, PTFE ball seat
- PTFE ball seat
- EPDM O-ring body seal, FKM O-ring stem seal
- 304 stainless steel nuts and bolts

Specification:

- pressure rating: ½" - 3" is rated to **125 PSI** at 70°F
- 4" is rated to **90 PSI** at 70°F

Polypropylene Compact Bolted Ball Valves



Sizes:

- 2" available, full port, female NPT x female NPT (*PVFPS···*)
- 2" available, full port, female NPT x male adapter (*PVFPSA···*)

Materials:

- chemically-resistant, reinforced polypropylene body, PTFE ball seat
- PTFE ball seat
- EPDM O-ring body seal, FKM O-ring stem seals
- 304 stainless steel nuts and bolts
- FDA approved material

Specification:

- pressure rating: **125 PSI** at 70°F

Polypropylene Bolted Ball Valves with Nozzles

Female NPT x Nozzle

Sizes:

- 1½" - 2" available, full port (*PVFPN...*)
- 2" available, standard port (*PVN...*)

Materials:

- chemically-resistant, reinforced polypropylene body, PTFE ball seat
- EPDM O-ring body seals, FKM O-ring stem seals
- 304 stainless steel nuts and bolts
- FDA approved material

Feature:

- body-to-flange design allows for low torque operation

Specification:

- pressure rating: **125 PSI** at 70°F



Polypropylene 45° Single Union Nozzle Valves

Female NPT x Nozzle

Size:

- 1" available, full port (*SUBVN100*)

Materials:

- corrosion resistant polypropylene body, PTFE ball seats
- EPDM O-ring
- FDA approved material

Specification:

- pressure rating: **125 PSI** at 70°F



Dixon®, founded in 1916, is a premier manufacturer and supplier of hose couplings, valves, dry-disconnects, swivels, and other fluid transfer and control products. The company's global reach includes a wide range of products for numerous industries including petroleum exploration, refining, transportation, chemical processing, food & beverage, steel, fire protection, construction, mining and manufacturing. Dixon®'s strategic objective is to create solutions that make products safer, leak-free, longer lasting, and always available.

dixonvalve.com • *Customer Service: 877.963.4966*



The Right Connection®

Dixon®

800 High Street, Chestertown, MD 21620

ph: 877.963.4966

fx: 800.283.4966



Dixon®
Customer Service