



Uncommon Excellence™

1916 - 2016

**DIXON
BRASS**



The Right Connection®

2016

**DIXONVALVE.COM
877.963.4966**

Index

SERIES NUMBER	PAGE
STANDARD HOSE FITTINGS	
102 Male Pipe.....	2
102-SS Male Pipe-Stainless.....	2
102-BSPT Male Pipe-British Thread.....	2
103 Male Pipe Swivel.....	3
104 Female Pipe.....	3
104-SS Female Pipe-Stainless Steel.....	3
105 Female Pipe Swivel.....	4
124 Female Swivel-Ball Seat.....	4
126 Female Swivel-Gasket Seat.....	4
129 90° Elbow, Male Pipe.....	5
129-SS 90° Elbow, Male Pipe-Stainless Steel.....	5
134 90° Elbow, Female Pipe.....	5
139 45° Elbow, Male Pipe.....	6
142 Male 45° SAE.....	6
143 Female Swivel 45° SAE/37° JIC Dual Angle Seat.....	6
144 Female Swivel 45° SAE.....	7
145 Female Swivel 37° JIC.....	7
177 90° Elbow Splicer.....	7
177-SS 90° Elbow Splicer-Stainless Steel.....	8
178 Hose Splicer.....	8
178-SS Hose Splicer-Stainless Steel.....	8
179 Tee Splicer.....	9
179-SS Tee Splicer-Stainless Steel.....	9

WELDING CONNECTORS	
152 Right Hand Thread (Oxygen Line).....	10
154 Left Hand Thread (Acetylene Line).....	10
156 Adapter-Right Hand Thread x NPTF Thread.....	11
158 Adapter-Left Hand Thread x NPTF Thread.....	11

BRASS FERRULES & CRIMPING TOOL	
200 Stamped Brass Ferrules.....	12
200-FC Ferrule Crimper.....	12

RE-USABLE FITTINGS	
180 Ferrule.....	14
180-SS Ferrule-Stainless Steel.....	14
182 Male Stem.....	14
182-SS Male Stem-Stainless Steel.....	14
183 Reusable Set- Ferrule and Male Stem.....	15
183-SS Reusable Set- Stainless Steel.....	15
184 Female Swivel Stem.....	16
185 Reusable Set- Ferrule and Female Swivel Stem.....	16
186 Reusable Splicer Stem.....	17
187 Hose Splicer (Ferrules and Splicer).....	17

SERIES NUMBER	PAGE
BEADED HOSE FITTINGS	
268B Male Pipe.....	17

LOK-ON (Push-on Style) HOSE FITTINGS	
270-AT Assembly Tool.....	18
271 Male Pipe Swivel.....	18
272 Male Pipe.....	19
272W Yellow Lok-on Cap.....	19
272-SS Male Pipe-Stainless Steel.....	19
273 90° Elbow, Male Pipe.....	20
274 Female Pipe.....	20
572 Male GH Thread.....	21
574 Female GH Thread.....	21
575 Garden Hose Set.....	21
278 Female Swivel-Ball Seat.....	22
280 Female Swivel-Gasket Seat.....	22
282 Male 45° SAE.....	22
284 Female Swivel 45° SAE.....	23
286 Male 37° JIC.....	23
287 Female Swivel 45° SAE/37° JIC Dual Angle Seat.....	23
287-SS Female Swivel 45° SAE/37° JIC Dual Angle Seat-Stainless Steel.....	23
288 Female Swivel 37° JIC.....	24
288-SS Female Swivel 37° JIC-Stainless Steel.....	24
289 Female Swivel 90° Elbow.....	24
290 Male Swivel SAE Inverted Flare.....	24
292 Female SAE Inverted Flare.....	25
294 Rigid Tube Shank.....	25
294-SS Rigid Tube Shank - Stainless Steel.....	25
296 Hose Splicer.....	25
296-SS Hose Splicer-Stainless Steel.....	25

BRASS PIPE FITTINGS	
163 Hex Head Plug.....	26
165 Close Pipe Nipple.....	26
166 Long Pipe Nipple.....	26-27
169 90° Male Pipe Elbows.....	27
172 Male Union-NPSM x NPTF.....	27
174 Adapter-Male NPSM x Female NPTF.....	27
176 Male Union-NPSM.....	28
207-BH Bulkhead Anchor Coupling.....	28
211 Square Head Plug - Low Lead.....	28
213 Pipe Cap.....	29
219 Hex Socket Plug - Low Lead.....	29
228 Female Cross.....	29
302 90° Female Elbow.....	30
304 90° Street Elbow.....	30
306 45° Street Elbow.....	30
322 Female Tee.....	31
324 Male Branch Tee.....	31
326 Street Tee.....	31
370 Male Hex Nipple.....	32
371 Female Hex Coupling.....	32
373 Reducer Bushing.....	32
375 Adapter-Female x Male.....	33
377 Reducing Coupler-Double Female.....	33
379 Male Reducing Hex Nipple.....	33

Index

SERIES NUMBER		PAGE
GARDEN HOSE FITTINGS		
500	Garden Hose Accessory Products.....	34
501	Female Hose x Female Pipe, non-swivel	35
501-SS	Female Hose x Female Pipe, non-swivel Stainless Steel.....	35
502	Female Hose x Female Pipe, swivel.....	35
502-SS	Female Hose x Female Pipe, swivel Stainless Steel.....	35
503	Female Hose x Male Pipe, non-swivel.....	35
503-SS	Female Hose x Male Pipe, non-swivel Stainless Steel.....	35
504	Female Hose x Male Pipe, swivel.....	35
504-SS	Female Hose x Male Pipe, swivel Stainless Steel.....	35
506	Female Hose x Female Hose, swivel	36
507	Male Hose x Female Pipe.....	36
507-SS	Male Hose x Female Pipe - Stainless Steel.....	36
508	Male Hose x Male Pipe.....	36
508-SS	Male Hose x Male Pipe - Stainless Steel.....	36
509	Male Hose x Male Hose.....	36
509-SS	Male Hose x Male Hose - Stainless Steel.....	36
513	Hose Cap.....	37
514	Male Hose x Male Pipe x Female Pipe.....	37
514-SS	Male Hose x Male Pipe x Female Pipe - Stainless Steel.....	37
578	Garden Hose Mender	37
585	Short Shank Male	37
586	Short Shank Female Swivel, round nut	38
587	Short Shank Set (male and female swivel), round nut.....	38
588	Short Shank Female Swivel, hex nut.....	38
589	Short Shank Set (male and female swivel), hex nut	38
590	Garden Hose Male.....	39
590-SS	Garden Hose Male - Stainless Steel.....	39
591	Garden Hose Female Swivel.....	39
591-SS	Garden Hose Female - Stainless Steel	39
592	Garden Hose Set (male and female swivel)	39
592-SS	Garden Hose Set (male and female swivel) - Stainless Steel.....	39
593	Long Shank Male.....	40
594	Long Shank Female Swivel	40
595	Long Shank Set (male and female swivel)	40
833	Spray Valve.....	41
832	Spray Valve.....	41

GWH	Grease Whip Hose Assemblies, Coupler and Fittings.....	42
GWHZ	Zerk Fittings	42

Because of the health hazards associated with contamination and lead content in drinking water systems, Dixon couplings, unless otherwise specifically approved, are not recommended for potable water service and should not be used in applications where drinking water will contact the wetted surfaces of the couplings.

SERIES NUMBER		PAGE
COMPRESSION FITTINGS		
60C	Sleeve.....	43
60PT	Acetal Sleeve.....	43
61C	Nut	43
61CL	Long Nut	43
62C	Union	44
62CBH	Bulkhead Union	44
63PT	Brass Insert.....	44
66C	Female Connector	45
68C	Male Connector	45
164C/		
264C	Union Tee.....	46
165C	Union Elbow.....	46
169C/		
269C	Male Elbow	47
170C	Female Elbow	47
171C	Male Run Tee.....	47
172C	Male Branch Tee.....	48
176C	Adapter Tee	48
177C	Female Branch Tee.....	48
179C	45° Elbow	48
639C	Seal Plug	49
682C	Straight Thru Tank Fitting.....	49

D.O.T. AIR BRAKE FITTINGS		
60NAB	Sleeve.....	50
61NAB	Nut	51
62NAB	Union	51
62NABH	Bulkhead Union	51
62NBH	Bulkhead Union	51
62NFBH	Bulkhead Union	52
63NAB	Stainless Insert.....	52
64NAB	Union Tee.....	52
65NAB	Union Elbow.....	53
66NBH	Bulkhead Union	53
66NAB	Female Connector	53
68NAB	Male Connector	54
69NAB	Male Elbow	54
70NAB	Female Elbow	55
71NAB	Male Run Tee.....	55
72NAB	Male Branch Tee.....	56
79NAB	45° Elbow	56
NAB	Nylon Tubing.....	50
TC97	Tubing Cutter	50

D.O.T. AIR BRAKE FITTINGS - RUBBER AIR HOSE		
56RBSG	Spring	57
60RB	Sleeve.....	57
61RB	Nut	57
61RBSG	Spring Guard Nut.....	57
67RBSG	Air Brake Hose Nut & Attached Spring	57
68RB	Male Connector Body Only	58
68RBSG	Male Connector with Spring Guard.....	58

LEAD FREE FITTINGS		
LEAD FREE	59-63



In order to better serve you, Dixon Brass continues to produce non-catalog sizes and products on a special quote / delivery basis. Please contact your sales representative for further details.

Standard Hose Fittings

**How to Use
Dixon Brass
Standard Hose Fitting
Part Numbers**

1020406C

1020406C

1020406C

1020406C

SERIES IDENTIFICATION

HOSE I.D. (Measured in sixteenths of an inch)

THREAD SIZE (Measured in sixteenths of an inch)

MATERIAL/THREAD TYPE

Dixon Brass offers over 180 standard hose fittings in 20 different series. All standard hose fittings are intended for use with hose clamps or crimped ferrules.

All standard hose fittings are machined from free cutting brass alloys CDA, 360 and 377 and stainless steel alloys 316, 303 or 304.

102 Series
360 CDA Brass

102-SS Series
Type 316 stainless

102-BSPT Series
British Standard Pipe Thread
360 CDA Brass

For SS contact Dixon for price and availability

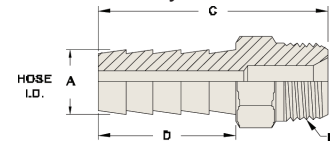

NPTF- MALE HOSE BARB

National Pipe Tapered - Dryseal

Standard Brass Part Number	SS	BSPT	Hose ID A	NPTF ** Thread B	Length C	Hex	Number of Barbs	Barb Length D	Std. Pkg.	Lbs. per 100 pcs.
1020202C	SS		1/8	1/8-27	1.06	7/16	3	.46	100 *	1.8
1020204C				1/4-18	1.16	9/16	3	.46	100	3.1
1020302C	SS		3/16	1/8-27	1.35	7/16	3	.75	100 *	2.2
1020304C	SS			1/4-18	1.54	9/16	3	.75	100 *	4.0
1020402C	SS	BSPT	1/4	1/8-27	1.57	1/2	4	.97	100 *	2.9
1020404C	SS	BSPT		1/4-18	1.76	9/16	4	.97	100 *	4.3
1020406C	SS			3/8-18	1.76	11/16	4	.97	100 *	5.4
1020408C				1/2-14	1.97	7/8	4	.97	50	13.8
1020502C	SS		5/16	1/8-27	1.57	1/2	4	.97	100 *	2.9
1020504C	SS			1/4-18	1.76	9/16	4	.97	50 *	4.3
1020506C	SS			3/8-18	1.76	11/16	4	.97	50 *	5.6
1020602C	SS			1/8-27	1.57	1/2	4	.97	100 *	3.8
1020604C	SS	BSPT		1/4-18	1.76	9/16	4	.97	100 *	4.8
1020606C	SS	BSPT	3/8	3/8-18	1.76	11/16	4	.97	50 *	6.1
1020608C	SS	BSPT		1/2-14	1.97	7/8	4	.97	25 *	10.8
1020612C				3/4-14	1.97	1-1/16	4	.97	25	14.9
1020804C	SS		1/2	1/4-18	1.76	5/8	4	.97	50 *	6.7
1020806C	SS	BSPT		3/8-18	1.76	11/16	4	.97	50 *	6.9
1020808C	SS	BSPT		1/2-14	1.97	7/8	4	.97	25 *	12.0
1020812C	SS			3/4-14	1.97	1-1/16	4	.97	25 *	15.7
1021006C	SS		5/8	3/8-18	1.76	11/16	4	.97	50 *	7.8
1021008C	SS			1/2-14	1.97	7/8	4	.97	25 *	11.6
1021012C	SS			3/4-14	1.97	1-1/16	4	.97	25 *	15.7
1021208C	SS		3/4	1/2-14	2.19	7/8	4	1.19	25 *	16.4
1021212C	SS	BSPT		3/4-14	2.19	1-1/16	4	1.19	20 *	18.0
1021612C	SS		1	3/4-14	2.19	1-1/16	5	1.19	20 *	25.0
1021616C		BSPT		1-11-1/2++	2.54	1-3/8	5	1.19	10 *	37.1
1022012C			1-1/4	3/4-14	2.37	1-3/8	5	1.19	10	38.7
1022016C				1-11-1/2++	2.54	1-3/8	5	1.19	5	46.9

* 102-SS and 102-BSPT are packaged to order

** NPT thread on 102-SS

++ capped

Standard Hose Fittings

103 Series

NPTF- MALE SWIVEL HOSE BARB
National Pipe Tapered - Dryseal

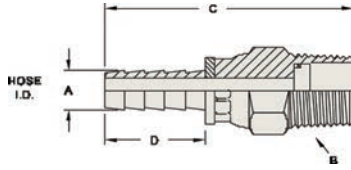

Part Number	Hose ID A	NPTF Thread B	Length C	Hex	Number of Barbs	Barb Length D	Std. Pkg.	Lbs. per 100 pcs.
1030402C	1/4	1/8-27	2.19	9/16	4	.97	100	3.5
1030404C		1/4-18	2.12	9/16	4	.97	100	6.0
1030604C	3/8	1/4-18	2.12	9/16	4	.97	100	6.6
1030606C		3/8-18	2.12	11/16	4	.97	50	8.4
1030806C	1/2	3/8-18	2.12	11/16	4	.97	50	9.7
1030808C		1/2-14	2.33	7/8	4	.97	25	14.1
1031212C	3/4	3/4-14	2.33	1-1/16	4	.97	20	20.7
1031616C	1	1-11-1/2 +	3.43	1-3/8	5	1.19	10	40.0

Note: Swivel for assembly convenience only, not for live swivel applications, 120 maximum PSI
+ capped threads

104 Series
360 CDA Brass

NPTF- FEMALE HOSE BARB - SOLID
National Pipe Tapered - Dryseal

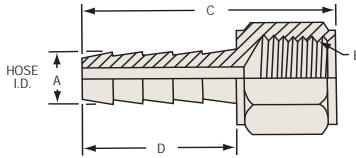

Part Number	303 SS	Hose ID A	NPTF ** Thread B	Length C	Hex	Number of Barbs	Barb Length D	Std. Pkg.	Lbs. per 100 pcs.
1040202C		1/8	1/8-27	.96	1/2	3	.46	100	2.1
1040204C			1/4-18	1.15	5/8	3	.46	100	4.0
1040302C		3/16	1/8-27	1.25	1/2	3	.75	100	2.4
1040304C			1/4-18	1.44	5/8	3	.75	100	4.3
1040402C	SS	1/4	1/8-27	1.47	1/2	4	.97	100	2.8
1040404C			1/4-18	1.66	5/8	4	.97	100 *	4.6
1040406C			3/8-18	1.66	3/4	4	.97	50	5.6
1040408C			1/2-14	1.66	15/16	4	.97	50	8.1
1040502C		5/16	1/8-27	1.47	9/16	4	.97	100	3.6
1040504C			1/4-18	1.66	5/8	4	.97	100	4.7
1040506C			3/8-18	1.66	3/4	4	.97	50	5.7
1040602C	SS	3/8	1/8-27	1.47	9/16	4	.97	100	4.2
1040604C			1/4-18	1.66	5/8	4	.97	50 *	5.4
1040606C			3/8-18	1.66	3/4	4	.97	50 *	6.3
1040608C			1/2-14	1.66	15/16	4	.97	50	8.8
1040612C		1/2	3/4-14	1.97	1-3/16	4	.97	25	20.6
1040804C			1/4-18	1.66	5/8	4	.97	50	6.2
1040806C			3/8-18	1.66	3/4	4	.97	50	7.3
1040808C			1/2-14	1.66	15/16	4	.97	50 *	9.3
1040812C		3/4	3/4-14	1.97	1-3/16	4	.97	25 *	25.8
1041006C			3/8-18	1.66	3/4	4	.97	50 *	7.5
1041008C			1/2-14	1.66	3/4	4	.97	25 *	10.0
1041012C		1	3/4-14	1.97	1-3/16	4	.97	25 *	20.6
1041208C			1/2-14	1.88	15/16	4	1.19	25 *	12.5
1041212C		1	3/4-14	2.19	1-3/16	4	1.19	20 *	22.6
1041612C			3/4-14	2.19	1-3/16	5	1.19	20 *	26.1
1041616C		1-1/4	1-11-1/2	2.32	1-3/16	5	1.19	10 *	34.7
1042016C			1-11-1/2	2.32	1-7/16	5	1.19	10	43.7

* 104-SS are packaged to order

** NPT thread on 104-SS

105 Series

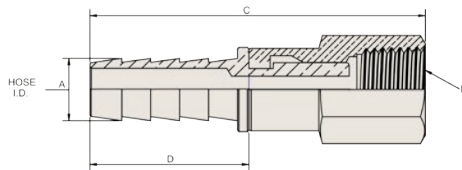

PTF-Short - FEMALE SWIVEL HOSE BARB

Short Pipe Tapered - Dryseal

Part Number	Hose ID A	PTF-Short Thread B	Over All Length C	Hex	Number of Barbs	Barb Length D	Std. Pkg.	Lbs. per 100 pcs.
1050404C	1/4	1/4-18	2.20	5/8	4	.97	50	5.6
1050604C	3/8	1/4-18	2.20	5/8	4	.97	50	6.2
1050606C		3/8-18	2.20	3/4	4	.97	50	8.7
1050806C	1/2	3/8-18	2.20	3/4	4	.97	50	8.7
1050808C		1/2-14	2.40	15/16	4	.97	25	14.3

Note: Swivel for assembly convenience only, not for live swivel applications.

124 Series

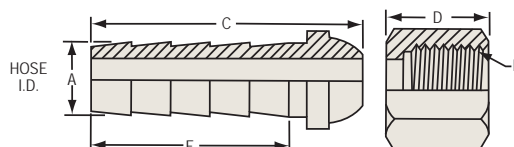

NPSM - FEMALE SWIVEL HOSE BARB

National Pipe Straight - Ball Seat Type

Part Number	Hose ID A	NPSM Thread B	Stem Length C	Nut Length D	Hex	Number of Barbs	Barb Length E	Std. Pkg.	Lbs. per 100 pcs.
1240202K	1/8	1/8-27	.79	.44	1/2	3	.46	100	2.3
1240302K	3/16	1/8-27	1.08	.44	1/2	3	.75	100	2.6
1240304K		1/4-18	1.17	.53	5/8	3	.75	100	4.5
1240402K	1/4	1/8-27	1.30	.44	1/2	4	.97	100	3.0
1240404K		1/4-18	1.39	.53	5/8	4	.97	100	4.8
1240406K	5/16	3/8-18	1.41	.63	3/4	4	.97	100	6.7
1240504K		1/4-18	1.39	.53	5/8	4	.97	100	5.0
1240506K	3/8-18	1.41	.63	3/4	4	.97	50	6.6	
1240604K	3/8	1/4-18	1.37	.53	5/8	4	.97	100	4.9
1240606K		3/8-18	1.45	.63	3/4	4	.97	100	7.1
1240608K	1/2	1/2-14	1.54	.69	15/16	4	.97	100	12.4
1240806K		3/8-18	1.42	.63	3/4	4	.97	50	7.5
1240808K	1/2-14	1.54	.69	15/16	4	.97	100	12.7	
1241212K	3/4	3/4-14	1.69	.75	1-1/8	4	1.19	50	17.4

126 Series

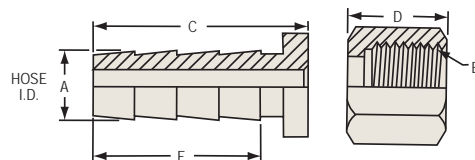

NPSM - FEMALE SWIVEL HOSE BARB

National Pipe Straight - Gasket Seat Type

Part Number	Hose ID A	NPSM Thread B	Stem Length C	Nut Length D	Hex	Number of Barbs	Barb Length E	Std. Pkg.	Lbs. per 100 pcs.
1260202C	1/8	1/8-27	.69	.44	1/2	3	.46	100	2.2
1260302C	3/16	1/8-27	.98	.44	1/2	3	.75	100	2.5
1260304C		1/4-18	.98	.53	5/8	3	.75	100	4.0
1260402C	1/4	1/8-27	1.20	.44	1/2	4	.97	100	2.7
1260404C		1/4-18	1.20	.53	5/8	4	.97	100	4.3
1260406C	5/16	3/8-18	1.22	.63	3/4	4	.97	100	6.0
1260504C		1/4-18	1.20	.53	5/8	4	.97	100	4.2
1260604C	3/8	1/4-18	1.20	.53	5/8	4	.97	100	4.6
1260606C		3/8-18	1.22	.63	3/4	4	.97	50	6.4
1260608C	1/2	1/2-14	1.22	.69	15/16	4	.97	50	10.4
1260806C		3/8-18	1.22	.63	3/4	4	.97	50	7.0
1260808C	1/2-14	1.22	.69	15/16	4	.97	50	11.0	
1261212C	3/4	3/4-14	1.47	.75	1-1/8	4	1.19	25	15.6

Not recommended for use with water

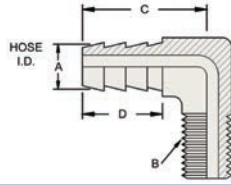

90° ELBOW- Forged
Hose Barb to Male NPTF

Part Number	Hose ID A	NPTF Thread B	Length Centerline C	Number of Barbs	Barb Length D	Std. Pkg.	Lbs. per 100 pcs.
1290302C	3/16	1/8-27	1.05	3	.79	50	3.3
1290402C		1/8-27	1.05	3	.79	50	3.4
1290404C	1/4	1/4-18	1.14	3	.79	50	6.2
1290406C		3/8-18	1.16	3	.79	50	7.3
1290502C		1/8-27	1.05	3	.79	25	3.1
1290504C	5/16	1/4-18	1.14	3	.79	50	6.1
1290506C		3/8-18	1.16	3	.79	50	6.5
1290602C		1/8-27	1.09	3	.87	50	3.6
1290604C	3/8	1/4-18	1.14	3	.87	50	6.6
1290606C		3/8-18	1.22	3	.87	50	8.9
1290608C		1/2-14	1.29	3	.87	25	13.1
1290804C		1/4-18	1.17	3	.87	50	6.3
1290806C	1/2	3/8-18	1.24	3	.87	50	8.3
1290808C		1/2-14	1.29	3	.87	25	12.3
1291006C	5/8	3/8-18	1.31	3	.87	25	17.2
1291008C		1/2-14	1.36	3	.87	25	18.6
1291208C	3/4	1/2-14	1.36	3	.87	25	23.2
1291212C		3/4-14	1.44	3	.87	25	21.5
1291612C	1	3/4-14	1.65	4	.98	10	37.1
1291616C		1-11-1/2 ++	1.69	4	.98	10	42.5

++Capped

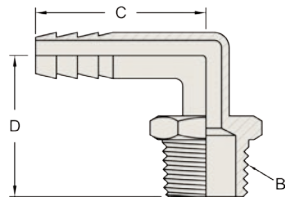

129-SS (316 stainless) Series



90° ELBOW - Casting
Hose Barb to Male NPT

Part Number	Hose ID A	NPT Thread B	Length Centerline C	Number of Barbs	Height Centerline D	Lbs. per 100 pcs.
1290402SS	1/4	1/8-27	1.1	3	.85	3.5
1290404SS	1/4	1/4-18	1.47	4	1.11	7.0
1290604SS	3/8	1/4-18	1.25	3	1.01	7.4
1290606SS	3/8	3/8-18	1.38	3	1.17	9.3
1290804SS	1/2	1/4-18	1.45	4	1.50	6.6
1290806SS	1/2	3/8-18	1.60	4	1.25	8.8
1290808SS	1/2	1/2-14	1.64	4	1.42	12.6
1291208SS	3/4	1/2-14	1.87	4	1.45	23.6
1291212SS	3/4	3/4-14	1.96	4	1.65	21.7

129-SS parts are packaged to order

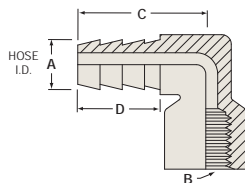

134 Series



90° ELBOW- Forged
Hose Barb to Female NPTF

Part Number	Hose ID A	NPTF Thread B	Length Centerline C	Number of Barbs	Barb Length D	Std. Pkg.	Lbs. per 100 pcs.
1340402C	1/4	1/8-27	1.05	3	.79	50	6.9
1340404C	1/4	1/4-18	1.14	3	.79	50	8.1
1340604C	3/8	1/4-18	1.14	3	.79	50	9.4
1340606C	3/8	3/8-18	1.22	3	.79	50	12.5
1340804C	1/2	1/4-18	1.17	3	.87	25	9.4
1340806C	1/2	3/8-18	1.24	3	.89	25	12.5
1340808C	1/2	1/2-14	1.29	3	.87	25	28.1
1341212C	3/4	3/4-14	1.52	3	.97	25	50.1

139 Series

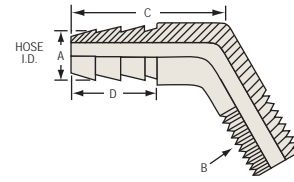

45° ELBOW- Forged
Hose Barb to Male NPTF

Part Number	Hose ID A	NPTF Thread B	Length Centerline C	Number of Barbs	Barb Length D	Std. Pkg.	Lbs. per 100 pcs.
1390402C	1/4	1/8-27	.96	3	.79	100	3.4
1390404C		1/4-18	1.01	3	.79	25	6.2
1390602C	3/8	1/8-27	1.03	3	.87	100	3.6
1390604C		1/4-18	1.05	3	.87	100	6.6
1390606C		3/8-18	1.10	3	.87	25	8.9
1390804C	1/2	1/4-18	1.10	3	.87	25	6.3
1390806C		3/8-18	1.10	3	.87	25	8.3
1390808C		1/2-14	1.15	3	.87	50	12.3
1391208C		3/4	1/2-14	1.15	3	.87	25

142 Series

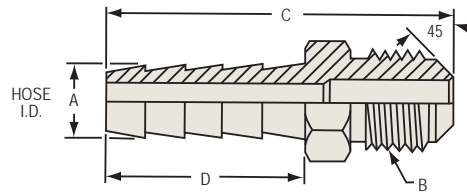

MALE HOSE BARB
45° SAE

Part Number	Hose ID A	Tube OD	UNF Thread B	Length C	Hex	Number of Barbs	Barb Length D	Std. Pkg.	Lbs. per 100 pcs.
1420307C	3/16	1/4	7/16-20	1.50	7/16	3	.75	100	2.7
1420407C	1/4	1/4	7/16-20	1.72	7/16	4	.97	100	3.2
1420410C		3/8	5/8-18	1.82	5/8	4	.97	100	6.6
1420508C	5/16	5/16	1/2-20	1.75	1/2	4	.97	100	4.5
1420610C	3/8	3/8	5/8-18	1.82	5/8	4	.97	50	7.6
1420612C		1/2	3/4-16	1.97	3/4	4	.97	50	9.9
1420812C		1/2	1/2	3/4-16	1.97	3/4	4	.97	50

143 Series

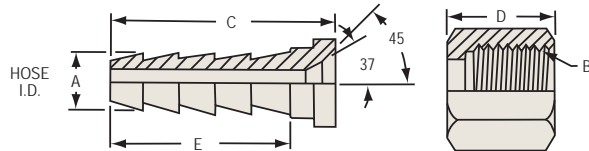

FEMALE SWIVEL HOSE BARB
45° SAE / 37° JIC (Dual Angle Seat)

Part Number	Hose ID A	Tube OD	UNF Thread B	Stem Length C	Nut Length D	Hex	Number of Barbs	Barb Length E	Std. Pkg.	Lbs. per 100 pcs.
1430307K	3/16	1/4	7/16-20	1.03	.60	9/16	3	.75	100	3.8
1430407K	1/4	1/4	7/16-20	1.25	.60	9/16	4	.97	100	4.1
1430408K		5/16	1/2-20	1.31	.68	5/8	4	.97	100	5.1
1430508K	5/16	5/16	1/2-20	1.31	.68	5/8	4	.97	100	5.1
1430612K	3/8	1/2	3/4-16	1.34	.84	7/8	4	.97	100	10.2
1430812K	1/2	1/2	3/4-16	1.34	.84	7/8	4	.97	100	10.9
1430814K		5/8	7/8-14	1.34	.96	1-1/16	4	.97	50	17.7

144 Series

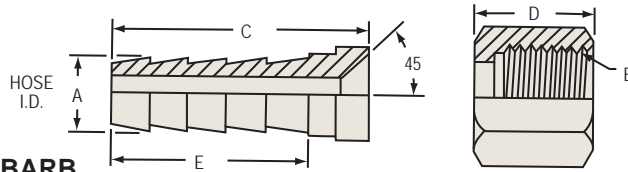

FEMALE SWIVEL HOSE BARB
45° SAE

Part Number	Hose ID A	Tube OD	UNF Thread B	Stem Length C	Nut Length D	Hex	Number of Barbs	Barb Length E	Std. Pkg.	Lbs. per 100 pcs.
1440306K	3/16	3/16	3/8-24	1.03	.45	7/16	3	.75	100	2.0
1440410K	1/4	3/8	5/8-18	1.27	.68	3/4	4	.97	100	6.7
1440510K	5/16	3/8	5/8-18	1.27	.68	3/4	4	.97	100	6.7
1440610K	3/8	3/8	5/8-18	1.27	.68	3/4	4	.97	100	7.2
1440812K	1/2	1/2	3/4-16	1.34	.84	7/8	4	.97	100	10.9
1441217K	3/4	3/4	1-1/16 - 14	1.47	1.03 *	1-1/4	4	.97	25	25.0

* Notch in nut for SAE identification

145 Series

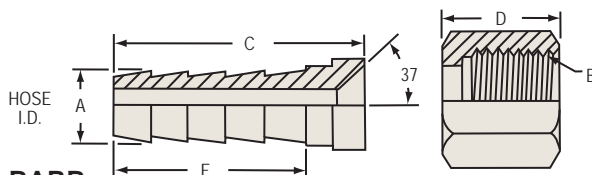

FEMALE SWIVEL HOSE BARB
37° JIC

Part Number	Hose ID A	Tube OD	UNF Thread B	Stem Length C	Nut Length D	Hex	Number of Barbs	Barb Length E	Std. Pkg.	Lbs. per 100 pcs.
1450609K	3/8	3/8	9/16-18	1.24	.63	11/16	4	.97	100	6.0
1451217K	3/4	3/4	1-1/16 - 12	1.47	1.03	1-1/4	4	.97	25	25.0

177 Series

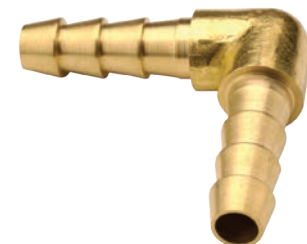
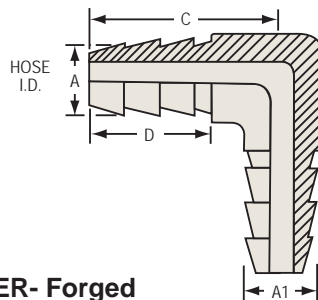

HOSE BARB 90° ELBOW SPLICER- Forged

Part Number	Hose ID A	Hose ID A1	Length Centerline C	Number of Barbs	Barb Length D	Std. Pkg.	Lbs. per 100 pcs.
1770202C	1/8	1/8	.73	3	.46	25	2.5
1770303C	3/16	3/16	1.05	3	.79	25	3.1
1770402C	1/4	1/8	1.05	3	.79	25	3.1
1770404C		1/4	1.05	3	.79	25	3.0
1770505C	5/16	5/16	1.15	3	.79	25	4.9
1770604C	3/8	1/4	1.15	3	.79	25	6.2
1770606C		3/8	1.15	3	.79	25	5.0
1770806C	1/2	3/8	1.25	3	.87	25	8.7
1770808C		1/2	1.25	3	.87	25	9.3
1771010C	5/8	5/8	1.30	3	.87	25	15.6
1771208C	3/4	1/2	1.41	3	.89	25	20.6
1771212C		3/4	1.41	3	.89	25	20.6

177-SS (304 stainless) Series

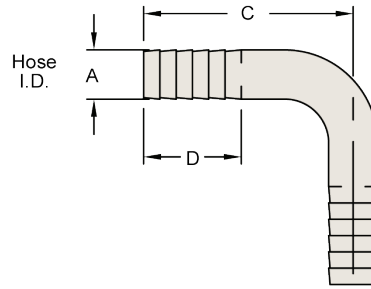

HOSE BARB 90° ELBOW SPLICER

Part Number	Hose ID A	Barb Length D	Length Centerline C	Number of Barbs	Lbs. per 100 pcs.
1770202SS	1/8	.36	.85	3	0.6
1770303SS	3/16	.54	1.68	5	1.9
1770404SS	1/4	.54	1.14	5	2.5
1770606SS	3/8	.56	1.46	5	4.0
1770808SS	1/2	.58	2.24	5	8.2

177-SS parts are packaged to order

178 and 178-SS (316 stainless) Series

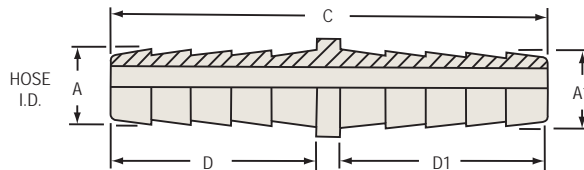

HOSE SPLICER

Part Number	SS	Hose ID A	Hose ID A1	Length C	Number of Barbs	Barb Length D	Barb Length D1	Std. Pkg.	Lbs. per 100 pcs.
1780202C		1/8	1/8	.97	3	.46	.46	100	0.6
1780303C		3/16	3/16	1.56	3	.75	.75	100	1.3
1780402C		1/4	1/8	1.55	4	.97	.46	100	2.0
1780404C	SS	1/4	1/4	2.03	4	.97	.97	100 *	2.3
1780505C		5/16	5/16	2.06	4	.97	.97	100	2.5
1780604C		3/8	1/4	2.06	4	.97	.97	100	3.7
1780606C	SS	3/8	3/8	2.06	4	.97	.97	100 *	4.0
1780806C		1/2	3/8	2.06	4	.97	.97	100	6.2
1780808C	SS	1/2	1/2	2.06	4	.97	.97	50 *	6.5
1781006C			3/8	2.06	4	.97	.97	50	6.2
1781008C		5/8	1/2	2.06	4	.97	.97	50	6.8
1781010C			5/8	2.06	4	.97	.97	50	7.0
1781208C		3/4	1/2	2.28	4	1.19	.97	25	10.6
1781212C	SS	3/4	3/4	2.50	4	1.19	1.19	25 *	12.8
1781616C		1	1	3.00	5	1.44	1.44	10	22.5

* 178-SS packaged to order

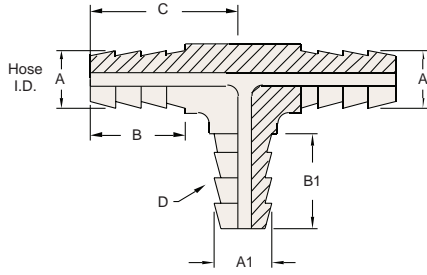

1790604C

**HOSE BARB- Forged
TEE SPLICER**

Part Number	Hose ID A	Hose ID A1	Barb Length B	Barb Length B1	Length Centerline C	NPTF Thread D	Number of Barbs	Std. Pkg.	Lbs. per 100 pcs.
1790202C	1/8	1/8	.46	.46	.71	--	3	25	3.1
1790303C	3/16	3/16	.71	.71	.94	--	3	100	3.1
1790402C	1/4	1/8	.71	.46	.94	--	3	25	4.4
1790404C	1/4	1/4	.71	.71	.94	--	3	25	3.4
1790505C	5/16	5/16	.79	.79	1.18	--	3	25	6.4
1790604C *	--	--	.86	--	1.26	1/4-18	3	25	11.2
1790604BARB	3/8	1/4	.86	.71	1.26	--	3	25	6.5
1790606C	--	3/8	.86	.86	1.26	--	3	25	8.0
1790806C	--	3/8	.90	.90	1.26	--	3	25	10.0
1790808C	1/2	1/2	.86	.86	1.26	--	3	25	10.4
1791010C	5/8	5/8	.90	.90	1.33	--	3	25	15.8
1791208C	3/4	1/2	.90	.90	1.41	--	3	25	22.5
1791212C	3/4	3/4	.90	.90	1.41	--	3	20	37.0

* 1790604C as pictured above

179-SS (304 stainless) Series

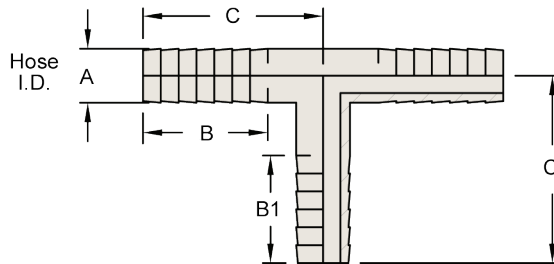

**HOSE BARB
TEE SPLICER**

Part Number	Hose ID A	Barb Length B	Barb Length B1	Length Centerline C	Number of Barbs	Lbs. per 100 pcs.
1790202SS	1/8	.50	.50	.62	4	1.3
1790303SS	3/16	.56	.56	.70	5	1.5
1790404SS	1/4	.63	.56 *	.94	6 / 5 *	2.5
1790606SS	3/8	.55	.55	1.01	5	3.2
1790808SS	1/2	.59	.55	1.01	5	5.6

* On Drop - 5 Barbs

179-SS parts are packaged to order

Welding Hose Fittings

Features:

- Dixon Brass offers 16 welding hose fitting in 4 different series.
- Our welding hose fittings are manufactured to exacting specifications.
- All welding hose fittings are packaged for easy storage and identification. Female swivel welding hose fittings (152 and 154 series) are sold in stem and swivel nut sets. Pricing information on separate components is available upon request.
- It is recommended that hose assemblies be fabricated using hose clamps or crimped ferrules in conjunction with hose barbs.

The following letter size designations are commonly used for both oxygen and fuel gas fitting size identification:

A-Size 3/8-24 UNF
B-Size 9/16-18 UNF

152 Series

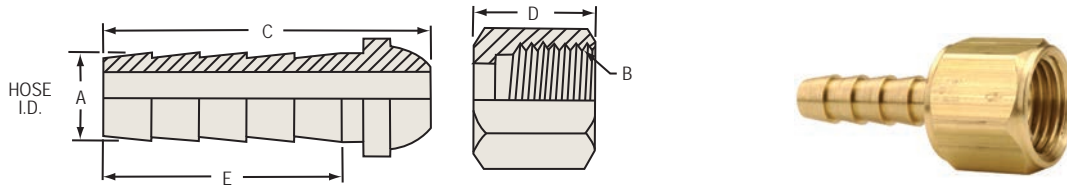

WELDING HOSE COUPLING

Right Hand Thread for Oxygen Line

Part Number	Hose ID A	Right UNF Thread B	Stem Length C	Nut Length D	Hex	Number of Barbs	Barb Length E	Std. Pkg.	Lbs. per 100 pcs.
1520306K	3/16	3/8-24	1.32	.45	7/16	4	.97	100	2.3
1520309K		9/16-18	1.43	.63	11/16	4	.97	100	6.1
1520409K	1/4	9/16-18	1.43	.63	11/16	4	.97	100	6.2
1520509K	5/16	9/16-18	1.43	.63	11/16	4	.97	100	6.6
1520609K	3/8	9/16-18	1.43	.63	11/16	4	.97	100	6.9

154 Series

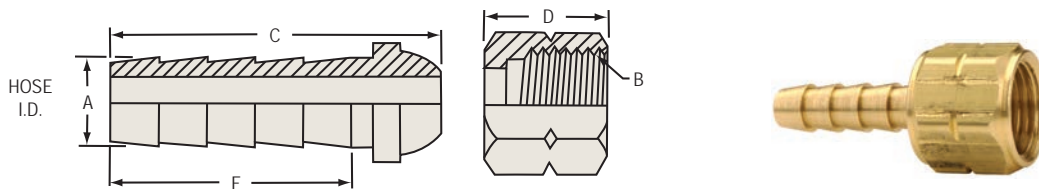

WELDING HOSE COUPLING

Left Hand Thread for Acetylene Line

Part Number	Hose ID A	Left UNF Thread B	Stem Length C	Nut Length D	Hex	Number of Barbs	Barb Length E	Std. Pkg.	Lbs. per 100 pcs.
1540306K	3/16	3/8-24	1.32	.45	7/16	4	.97	100	2.3
1540309K		9/16-18	1.43	.63	11/16	4	.97	100	6.1
1540409K	1/4	9/16-18	1.43	.63	11/16	4	.97	100	6.2
1540509K	5/16	9/16-18	1.43	.63	11/16	4	.97	100	6.6
1540609K	3/8	9/16-18	1.43	.63	11/16	4	.97	100	6.9

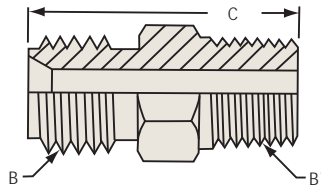

WELDING HOSE ADAPTER

Right Hand Thread

Part Number	Right UNF Thread B	NPTF Thread B'	Length C	Hex	Std. Pkg.	Lbs. per 100 pcs.
1560904C	9/16-18	1/4-18	1.30	5/8	100	5.8
1560906C	9/16-18	3/8-18	1.30	11/16	50	8.9

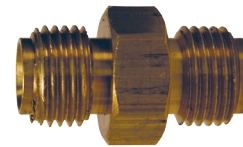
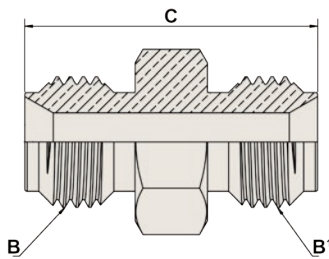

WELDING HOSE CONNECTOR

Right Hand Thread

Part Number	Right UNF Thread B	Right UNF Thread B'	Length C	Hex	Std. Pkg.	Lbs. per 100 pcs.
1560909C	9/16-18	9/16-18	1.25	11/16	100	6.9

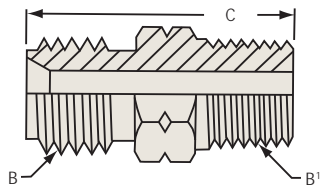

WELDING HOSE ADAPTER

Left Hand Thread

Part Number	Left UNF Thread B	NPTF Thread B'	Length C	Hex	Std. Pkg.	Lbs. per 100 pcs.
1580904C	9/16-18	1/4-18	1.30	5/8	100	5.8
1580906C	9/16-18	3/8-18	1.30	11/16	50	8.9

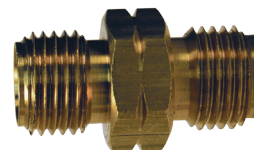
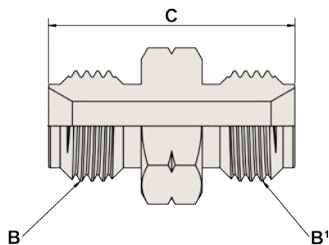

WELDING HOSE CONNECTOR

Left Hand Thread

Part Number	Left UNF Thread B	Left UNF Thread B'	Length C	Hex	Std. Pkg.	Lbs. per 100 pcs.
1580909C	9/16-18	9/16-18	1.25	11/16	100	6.9

Brass Ferrules and Crimping Tool

200 Series

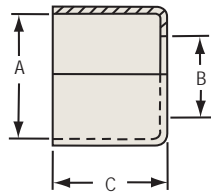

STAMPED BRASS FERRULE

Part Number	Reference No.	Ferrule ID A	Ferrule Length C	Hole Size B	Gauge	Std. Pkg. *	Lbs. per 100 pcs.
2004000C	619	.400	.47	.27	.020	100	.40
2004530C	769	.450	.56	.34	.016	50	.44
2004750C	4750	.478	.69	.33	.024	50	.76
2005000C	624	.500	.50	.34	.016	50	.40
2005005C	7322	.500	1.00	.34	.024	50	1.20
2005250C	625	.525	.50	.34	.016	50	.42
2005255C	7323	.525	1.00	.38	.024	50	1.18
2005310C	7324	.531	1.00	.44	.024	50	1.20
2005500C	626	.550	.48	.38	.016	50	.42
2005620C	7325	.562	1.00	.44	.024	50	1.28
2005930C	7326	.593	1.00	.44	.024	50	1.34
2006250C	II	.625	.50	.50	.019	50	.58
2006255C	7327	.625	1.00	.44	.024	50	1.44
2006500C	HH	.650	.50	.50	.019	50	.60
2006560C	7328	.656	1.00	.44	.024	50	1.48
2006750C	GG	.675	.52	.50	.019	100	.86
2006900C	7329	.687	1.00	.50	.024	50	1.52
2007180C	7330A	.718	1.00	.63	.024	50	1.62
2007250C	EE	.725	.53	.50	.019	50	.76
2007500C	DD	.750	.53	.50	.019	50	.96
2007505C	7331	.750	1.00	.63	.024	50	1.74
2007750C	CC	.775	.53	.50	.016	50	.90
2007810C	7332	.781	1.00	.63	.024	50	1.84
2008120C	7333	.812	1.00	.63	.024	50	1.94
2008750C	7244A	.875	.84	.69	.024	25	1.66
2009250C	7113	.925	.84	.69	.025	50	1.86
2009750C	5028A	.975	.84	.69	.024	25	1.96
2009950C	7104A	1.150	.84	.88	.024	50	2.36
2001025C	7114A	1.025	.84	.69	.024	25	2.40
2001100C	5027	1.100	.84	.81	.023	25	2.40
2001175C	7088A	1.175	.84	.88	.024	25	2.50
2001225C	875K	1.225	.875	.875	.025	25	2.50
2001500C	1500	1.500	.875	1.12	.025	25	3.50

* Sold in full bag quantity only



200FC FERRULE CRIMPING TOOL

Standard Die Part Number	Bore Die *	Hose OD **
200FC6A	.625	.640 - .671
200FC5	.578	.590 - .625
200FC4B	.531	.540 - .562
200FC4A	.484	.490 - .520
200FC6B	.687	.690 - .710

Features:

- Professional quality ferrule crimper provides fixed mount production capability or job-site portability
- Shipped with 5 standard die sets for 1/4" single braid hose through 3/8" 2-braid hose
- Optional die sets available for 3/16" and 1/2" hoses

Optional Die Part Number	Bore Die *	Hose OD **
200FC3	.375	.385 - .406
200FC8A	.750	.760 - .781
200FC8B	.812	.820 - .843

* See ferrule ID above

** Diameter with barbed insert installed

Re-usable Hose Fittings

Applications:

Reusable fittings are used when a more durable hose connection is required or ease of making a repair is a major consideration.

Features:

- Dixon Brass offers over 110 re-usable fittings in 10 different series.
- All re-usable fittings are of heavy duty construction.

Three variables must be determined before ordering.

1. I.D. of hose to be used with fitting
2. O.D. of hose to be used with fitting
3. Connection thread size desired

Part number for re-usable hose fitting sets (183, 185 and 187) series are easy to understand and use. The first three digits of the seven digit part number signify a specific product series. The fourth digit signifies the hose I.D. used with the fitting (measured in sixteenths of an inch). The fifth and sixth digits signify the hose O.D. used with the fitting (measured in sixteenths of an inch).

Note: Recommended for rubber covered hose only.

How to Use Dixon Brass Reusable Hose Fitting Part Numbers

1836116

1836116

1836116

1836116

SERIES IDENTIFICATION

HOSE I.D. (Measured in sixteenths of an inch)

HOSE O.D. (Measured in sixteenths of an inch)

THREAD SIZE (Measured in sixteenths of an inch)

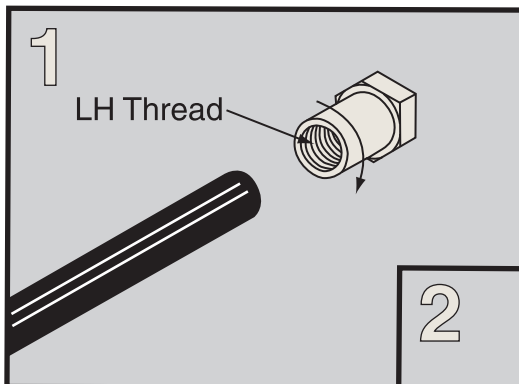

Simply slip and twist ferrule on end of hose which has been trimmed flush. No skiving necessary.

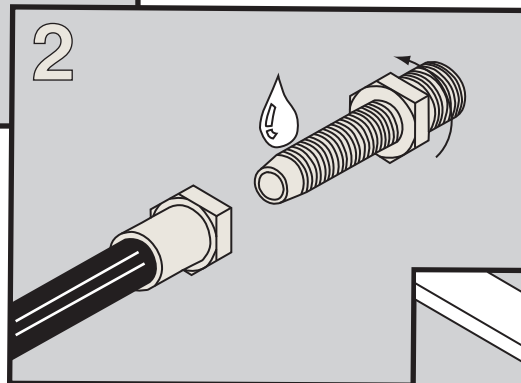

Apply a drop or two of lubricant to fitting before inserting ferrule.

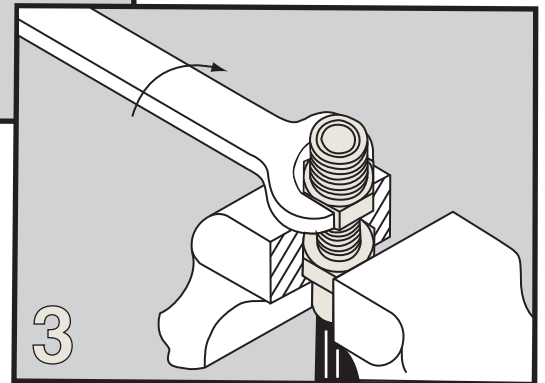

Turn reusable fitting into ferrule. Hose is expanded inside ferrule for perfect fit.

How to Install Reusable Fittings without Skiving or Crimping

180 and 180-SS Series

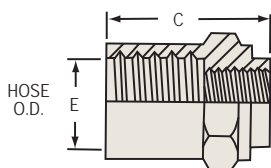

REUSABLE FERRULE

Standard Brass Part Number	303 SS	Hose ID	Hose OD E	Length C	Hex	Std. Pkg.	Lbs. per 100 pcs.
1800408F	SS		1/2	1.02	11/16	100 *	5.3
1800409F	SS	1/4	9/16	1.02	3/4	50 *	6.3
1800410F	SS		5/8	1.02	13/16	50 *	7.3
1800509F	SS		9/16	1.10	3/4	100 *	6.6
1800510F	SS	5/16	5/8	1.10	13/16	50 *	7.8
1800511F			11/16	1.10	7/8	50	8.6
1800610F	SS		5/8	1.10	13/16	50 *	7.2
1800611F	SS	3/8	11/16	1.10	7/8	50 *	8.3
1800612F	SS		3/4	1.10	7/8	50 *	6.7
1800814F	SS		7/8	1.69	1-1/16	25 *	15.8
1800815F	SS	1/2	15/16	1.69	1-1/8	25 *	17.5
1800816F			1	1.69	1-3/16	20	19.5

* 180-SS packaged to order

182 and 182-SS Series

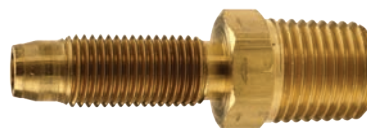
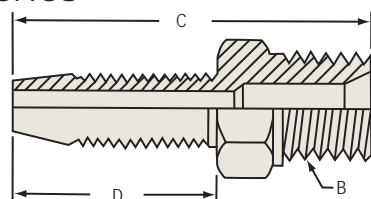

REUSABLE MALE STEM

Standard Brass Part Number	303 SS	Hose ID	NPTF ** Thread B	Length C	Stem Length D	Hex	Std. Pkg.	Lbs. per 100 pcs.
1820402S	SS		1/8-27	1.68	1.07	9/16	100 *	4.1
1820404S	SS	1/4	1/4-18	1.86	1.07	9/16	100 *	5.1
1820406S			3/8-18	1.86	1.07	11/16	50	6.5
1820504S	SS	5/16	1/4-18	1.96	1.17	9/16	50 *	5.5
1820506S			3/8-18	1.96	1.17	11/16	50	6.9
1820604S	SS		1/4-18	1.96	1.17	9/16	100 *	6.4
1820606S	SS	3/8	3/8-18	1.96	1.17	11/16	50 *	7.8
1820608S			1/2-14	2.17	1.17	7/8	25	12.7
1820804S			1/4-18	2.43	1.64	11/16	50	12.3
1820806S	SS	1/2	3/8-18	2.43	1.64	11/16	50 *	11.0
1820808S	SS		1/2-14	2.64	1.64	7/8	25 *	16.3

* 182-SS packaged to order

** NPT thread on 182-SS

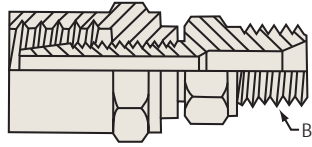
**REUSABLE MALE FITTING - UNASSEMBLED**

Standard Brass Part Number	303 SS	Hose ID	Hose OD	NPTF ** Thread B	Stem Hex	Ferrule Hex	Std. Pkg.	Lbs. per 100 pcs.
1834082K	SS		1/2	1/8-27	9/16	11/16	100 *	9.4
1834092K	SS	1/4	9/16	1/8-27	9/16	3/4	100 *	10.5
1834102K	SS		5/8	1/8-27	9/16	13/16	100 *	11.4
1834084K	SS		1/2	1/4-18	9/16	11/16	50 *	10.4
1834094K	SS	1/4	9/16	1/4-18	9/16	3/4	50 *	11.4
1834104K	SS		5/8	1/4-18	9/16	13/16	50 *	12.3
1834086K			1/2	3/8-18	11/16	11/16	50	11.8
1834096K		1/4	9/16	3/8-18	11/16	3/4	50	12.8
1834106K			5/8	3/8-18	11/16	13/16	50	13.8
1835094K	SS		9/16	1/4-18	9/16	3/4	50 *	12.1
1835104K	SS	5/16	5/8	1/4-18	9/16	13/16	50 *	13.4
1835114K			11/16	1/4-18	9/16	7/8	50	14.1
1835096K			9/16	3/8-18	11/16	3/4	50	13.5
1835106K		5/16	5/8	3/8-18	11/16	13/16	50	14.7
1835116K			11/16	3/8-18	11/16	7/8	50	15.5
1836104K	SS		5/8	1/4-18	9/16	13/16	50 *	13.6
1836114K	SS	3/8	11/16	1/4-18	9/16	7/8	50 *	14.7
1836124K	SS		3/4	1/4-18	9/16	7/8	50 *	13.1
1836106K	SS		5/8	3/8-18	11/16	13/16	50 *	15.0
1836116K	SS	3/8	11/16	3/8-18	11/16	13/16	50 *	16.1
1836126K	SS		3/4	3/8-18	11/16	7/8	50 *	14.6
1836108K			5/8	1/2-14	7/8	13/16	50	19.9
1836118K		3/8	11/16	1/2-14	7/8	7/8	50	21.0
1836128K			3/4	1/2-14	7/8	7/8	50	19.4
1838144K			7/8	1/4-18	11/16	1-1/16	25	28.1
1838154K		1/2	15/16	1/4-18	11/16	1-1/8	25	29.8
1838164K			1	1/4-18	11/16	1-3/16	25	31.8
1838146K	SS		7/8	3/8-18	11/16	1-1/16	25 *	26.8
1838156K	SS	1/2	15/16	3/8-18	11/16	1-1/8	25 *	28.5
1838166K			1	3/8-18	11/16	1-3/16	25	30.5
1838148K	SS		7/8	1/2-14	7/8	1-1/16	20 *	32.1
1838158K	SS	1/2	15/16	1/2-14	7/8	1-1/8	20 *	33.8
1838168K			1	1/2-14	7/8	1-3/16	20	35.8

* 183-SS packaged to order

** NPT thread on 183-SS

184 Series

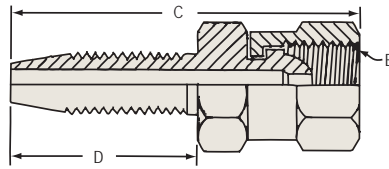

REUSABLE FEMALE SWIVEL STEM

Part Number	Hose ID A	NPSM Thread B	Length C	Stem Length D	Swivel Hex	Std. Pkg.	Lbs. per 100 pcs.
1840404A	1/4	1/4-18	1.94	1.07	11/16	50	7.8
1840406A		3/8-18	2.07	1.07	13/16	50	11.3
1840504A	5/16	1/4-18	2.12	1.17	11/16	50	9.4
1840604A	3/8	1/4-18	2.12	1.17	11/16	50	9.1
1840606A		3/8-18	2.20	1.17	13/16	50	12.5
1840808A	1/2	1/2-14	2.86	1.64	15/16	25	19.0

185 Series

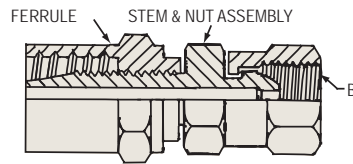

REUSABLE FEMALE SWIVEL FITTING - UNASSEMBLED

Part Number	Hose ID A	Hose OD	NPSM Thread B	Swivel Hex	Ferrule Hex	Std. Pkg.	Lbs. per 100 pcs.
1854084K	1/4	1/2	1/4-18	11/16	11/16	50	13.2
1854094K		9/16	1/4-18	11/16	3/4	50	14.2
1854104K		5/8	1/4-18	11/16	13/16	50	15.1
1854086K	1/4	1/2	3/8-18	13/16	11/16	50	16.6
1854096K		9/16	3/8-18	13/16	3/4	50	17.6
1854106K		5/8	3/8-18	13/16	13/16	50	18.6
1855094K	5/16	9/16	1/4-18	11/16	3/4	50	16.0
1855104K		5/8	1/4-18	11/16	13/16	50	17.3
1855114K		11/16	1/4-18	11/16	7/8	50	18.0
1856104K	3/8	5/8	1/4-18	11/16	13/16	50	16.3
1856114K		11/16	1/4-18	11/16	7/8	50	17.4
1856124K		3/4	1/4-18	11/16	7/8	50	15.8
1856106K	3/8	5/8	3/8-18	13/16	13/16	50	19.7
1856116K		11/16	3/8-18	13/16	7/8	50	20.8
1856126K		3/4	3/8-18	13/16	7/8	50	19.3
1858148K	1/2	7/8	1/2-14	15/16	1-1/16	20	34.8
1858158K		15/16	1/2-14	15/16	1-1/8	20	36.5
1858168K		1	1/2-14	15/16	1-3/16	20	38.5

186 Series

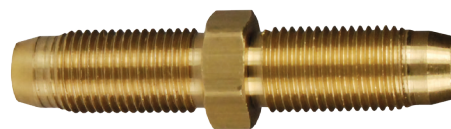
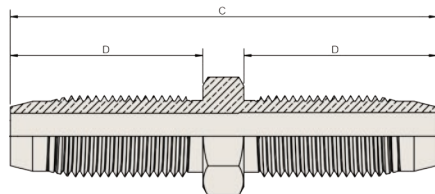

REUSABLE SPLICER STEM

Part Number	Hose ID	Length C	Stem Length D	Hex	Std. Pkg.	Lbs. per 100 pcs.
1860404S	1/4	2.39	1.07	9/16	100	6
1860606S	3/8	2.59	1.17	5/8	50	9

187 Series

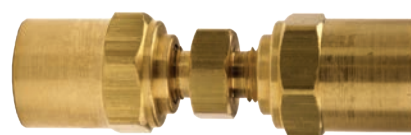
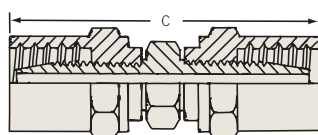

REUSABLE HOSE SPLICER - UNASSEMBLED

Part Number	Hose ID	Hose OD	Length C	Splicer Hex	Ferrule Hex	Std. Pkg.	Lbs. per 100 pcs.
1870408K	1/4	1/2	2.39	9/16	11/16	50	16.2
1870409K		9/16	2.39	9/16	3/4	50	18.2
1870410K		5/8	2.39	9/16	13/16	50	20.1
1870610K	3/8	5/8	2.59	5/8	13/16	25	23.1
1870611K		11/16	2.59	5/8	7/8	25	25.5
1870612K		3/4	2.59	5/8	7/8	25	22.3

268B Series

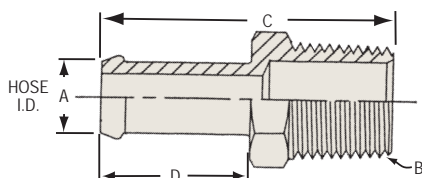

BEADED HOSE BARBS

Part Number	Hose ID A	NPTF Thread B	Length C	Hex	Barb Length D	Std. Pkg.	Lbs. per 100 pcs.
268B0402	1/4	1/8-27	1.18	1/2	.62	100	2.4
268B0404		1/4-18	1.41	9/16	.62	100	3.6
268B0502	5/16	1/8-27	1.22	1/2	.62	100	2.5
268B0504		1/4-18	1.41	9/16	.62	50	3.9
268B0602	3/8	1/8-27	1.48	1/2	.88	100	3.7
268B0604		1/4-18	1.67	9/16	.88	100	4.4
268B0606		3/8-18	1.67	11/16	.88	50	5.8
268B0806	1/2	3/8-18	1.67	11/16	.88	50	6.1
268B0808		1/2-14	1.88	7/8	.88	50	10.9
268B1008	5/8	1/2-14	1.88	7/8	.88	25	11.9
268B1208	3/4	1/2-14	1.88	7/8	.88	50	13.7
268B1212		3/4-14	1.88	1-1/16	.88	25	15.4

Lok-on Hose Fittings

Assembly Instructions

1. Trim hose end with a smooth square cut.
2. Lubricate either push-on fitting, hose or both.
3. Insert push-on fitting into hose until first barb is in the hose.
4. Place end of fitting against a flat object (bench, wall, etc.) and grip the hose one inch from the end. Push with a steady force until the end of the hose is covered by the yellow plastic cap.

Disassembly Instructions

1. Leaving push-on fitting in place, make a 1" cut in the hose along the barbed end of the fitting. Note: Be careful not to nick barbs when cutting the hose.
2. With firm grip on hose, give a sharp downward pull to release the fitting from the hose

- CAUTION: Push-on fittings will properly grip push-on hose only when pushed all the way in, with the cut end of the hose completely concealed by the plastic cap.



270AT Hose Fitting Installation Tool

Features:

- Cuts push-on style hose and inserts the fitting
- Built-in cutter slices through 1/4" - 3/4" I.D. reinforced push-on hose without fraying
- Clamp hose into tool's vice and apply light pressure on handle to drive in the fitting
- Tool has four 7/16" diameter mounting holes for bench mounting
- Overall size is 13-1/2" long x 2-3/8" wide x 7" height



Part Number	Description
270AT-RPLBlade	Replacement blade for the 270AT

271 Series

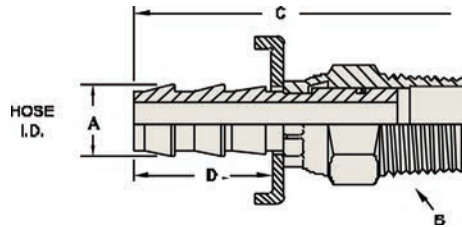

NPTF-MALE

SWIVEL HOSE BARB

National Pipe Tapered - Dryseal

Part Number	Hose ID A	NPTF Thread B	Length C	Hex	No. of Barbs	Barb Length D	Std. Pkg.	Lbs. per 100 pcs.
2710402C	1/4	1/8-27	2.09	9/16	2	.81	100	6.8
2710404C		1/4-18	2.02	9/16	2	.87	100	6.1
2710604C	3/8	1/4-18	2.12	9/16	2	.97	50	7.4
2710606C		3/8-18	2.12	11/16	2	.97	50	9.1
2710806C	1/2	3/8-18	2.12	11/16	2	.97	25	10.4
2710808C		1/2-14	2.33	7/8	2	.97	20	14.8
2711212C	3/4	3/4-14	2.80	1-1/16	3	1.45	10	24.8

Note: Swivel for assembly convenience only, not for live swivel applications, **120 maximum PSI**

**NPTF-MALE
HOSE BARB**

National Pipe Tapered - Dryseal

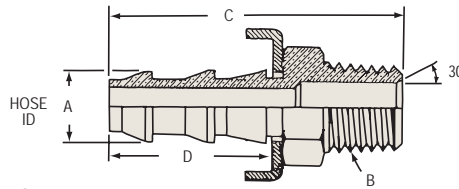

Part Number	303 SS	Hose ID A	NPTF ** Thread B	Length C	Hex	Number of Barbs	Barb Length D	Std. Pkg.	Lbs. per 100 pcs.
2720402C	SS		1/8-27	1.42	7/16	2	.77	100 *	2.7
2720404C	SS	1/4	1/4-18	1.61	9/16	2	.77	100 *	4.3
2720406C			3/8-18	1.61	11/16	2	.77	50	5.6
2720502C		5/16	1/8-27	1.42	7/16	2	.77	100	3.1
2720504C			1/4-18	1.61	9/16	2	.77	50	4.5
2720602C			1/8-27	1.60	9/16	2	.92	50	5.0
2720604C	SS		1/4-18	1.76	9/16	2	.92	50 *	5.3
2720606C	SS	3/8	3/8-18	1.76	11/16	2	.92	50 *	6.7
2720608C			1/2-14	1.97	7/8	2	.92	25	11.0
2720612C			3/4-14	1.97	1-1/16	2	.92	25	15.6
2720804C	SS		1/4-18	1.86	11/16	2	1.02	25	8.6
2720806C	SS	1/2	3/8-18	1.86	11/16	2	1.02	50 *	7.1
2720808C	SS		1/2-14	2.07	7/8	2	1.02	25 *	11.9
2720812C			3/4-14	2.07	1-1/16	2	1.02	25	16.3
2721006C			3/8-18	2.34	3/4	3	1.50	25	12.0
2721008C		5/8	1/2-14	2.55	7/8	3	1.50	25	14.3
2721012C			3/4-14	2.55	1-1/16	3	1.50	25	19.0
2721208C	SS	3/4	1/2-14	2.55	7/8	3	1.50	25 *	20.0
2721212C	SS		3/4-14	2.55	1-1/16	3	1.50	20 *	19.4
2721612C		1	3/4-14	2.93	1-1/4	3	1.50	10	43.7
2721616C	SS		1 - 11-1/2++	3.11	1-3/8	3	1.50	5 *	49.4

• Add a 'BC' suffix to the part number for the brass cap option. Not available for 5/16" I.D. hose size.

* 272-SS are packaged to order

** NPT thread on 272-SS

++capped



272W Series

Yellow Lok-on Cap

Part Number	Hose ID	Std. Pkg. *
2720400W	1/4	100
2720500W	5/16	100
2720600W	3/8	100
2720800W	1/2	100
2721000W	5/8	50
2721200W	3/4	50
2721600W	1	25

• Sold in full bag quantity only

273 Series

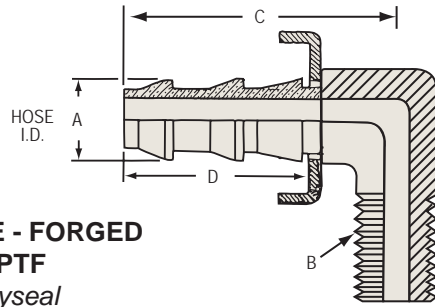

**NPTF - 90° ELBOW MALE - FORGED
HOSE BARB TO MALE NPTF**

National Pipe Tapered - Dryseal

Part Number	Hose ID A	NPTF Thread B	Length Centerline C	No. of Barbs	Barb Length D	Std. Pkg.	Lbs. per 100 pcs.
2730402C	1/4	1/8-27	1.22	2	.82	100	3.7
2730404C		1/4-18	1.40	2	.82	50	6.4
2730602C	3/8	1/8-27	1.35	2	.92	50	4.3
2730604C		1/4-18	1.40	2	.92	50	7.8
2730606C		3/8-18	1.51	2	.92	25	9.5
2730806C	1/2	3/8-18	1.54	2	1.02	25	13.2
2730808C		1/2-14	1.61	2	1.02	25	17.1
2731208C	3/4	1/2-14	2.15	3	1.50	10	25.3
2731212C		3/4-14	2.23	3	1.50	10	28.1

274 Series

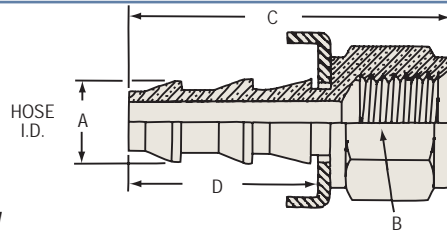

**NPTF-FEMALE
HOSE BARB**

National Pipe Tapered - Dryseal

Part Number	Hose ID A	NPTF Thread B	Length C	Hex	No. of Barbs	Barb Length D	Std. Pkg.	Lbs. per 100 pcs.
2740402C	1/4	1/8-27	1.32	1/2	2	.82	100	2.8
2740404C		1/4-18	1.51	5/8	2	.82	100	4.7
2740406C		3/8-18	1.51	3/4	2	.82	50	5.6
2740502C	5/16	1/8-27	1.32	1/2	2	.82	100	3.4
2740504C		1/4-18	1.51	5/8	2	.82	50	4.9
2740602C	3/8	1/8-27	1.47	9/16	2	.97	50	5.6
2740604C		1/4-18	1.66	5/8	2	.97	50	5.5
2740606C		3/8-18	1.66	3/4	2	.97	50	6.5
2740608C		1/2-14	1.66	15/16	2	.97	50	12.0
2740612C		3/4-14	1.97	1-3/16	2	.97	25	20.0
2740804C		1/4-18	1.76	11/16	2	1.07	50	7.8
2740806C	1/2	3/8-18	1.76	3/4	2	1.07	50	7.4
2740808C		1/2-14	1.76	15/16	2	1.07	25	10.0
2740812C		3/4-14	2.07	1-3/16	2	1.07	25	20.2
2741006C	5/8	3/8-18	2.24	3/4	3	1.55	25	10.0
2741008C		1/2-14	2.24	15/16	3	1.55	25	11.0
2741012C		3/4-14	2.55	1-3/16	3	1.55	25	23.0
2741208C	3/4	1/2-14	2.24	15/16	3	1.55	25	13.7
2741212C		3/4-14	2.55	1-3/16	3	1.55	20	23.5
2741612C	1	3/4-14	2.55	1-3/16	3	1.55	10	25.5
2741616C		1 - 11-1/2	2.68	1-7/16	3	1.55	10	37.5

NEW

• Add a 'BC' suffix to the part number for the brass cap option. Not available for 5/16" I.D. hose size.

Features:

- easy assembly, no need for ferrules or clamps
- these fittings must be used with Lok-On (push-on style) hose ONLY. 

572 Series

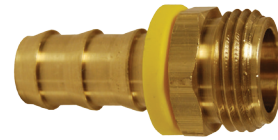
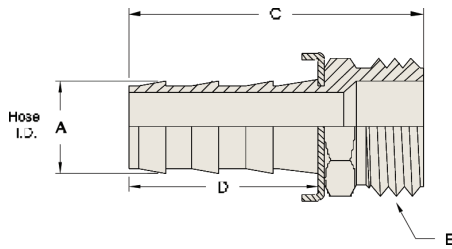

Lok-On Male Garden Hose Fittings

Part Number	Hose ID A	NH Thread B	Length C	Hex D	No. of Barbs	Barb Length D	Std. Pkg.	Lbs. per 100 pcs.
5720812C	1/2	3/4-11-1/2	1.83	1-1/16	2	1.02	25	12.3
5721012C	5/8	3/4-11-1/2	2.29	1-1/16	3	1.50	25	14.5
5721212C	3/4	3/4-11-1/2	2.29	1-1/16	3	1.50	25	15.1

574 Series

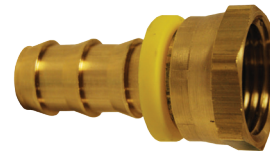
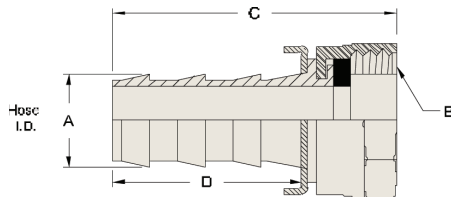

Lok-On Female Swivel Garden Hose Fittings

Part Number	Hose ID A	NH Thread B	Length C	Hex D	No. of Barbs	Barb Length D	Std. Pkg.	Lbs. per 100 pcs.
5740812C	1/2	3/4-11-1/2	1.79	1-3/16	2	1.02	25	11.5
5741012C	5/8	3/4-11-1/2	2.25	1-3/16	3	1.50	25	12.2
5741212C	3/4	3/4-11-1/2	2.25	1-3/16	3	1.50	25	13.5

575 Series

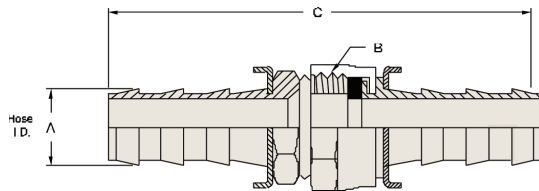

Lok-On Garden Hose Fitting Set - not assembled

Part Number	Hose ID A	NH Thread B	Length C	No. of Barbs	Std. Pkg.	Lbs. per 100 pcs.
5750808K	1/2	3/4-11-1/2	3.28	2	25	23.8
5751010K	5/8	3/4-11-1/2	4.23	3	25	26.7
5751212K	3/4	3/4-11-1/2	4.23	3	25	28.6

278 Series

**NPSM - FEMALE
SWIVEL HOSE BARB**

National Pipe Straight - Ball Seat Type

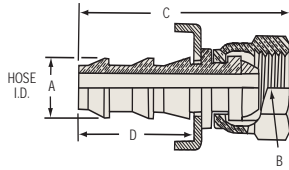

Part Number	Hose ID A	NPSM Thread B	Length C	Hex	No. of Barbs	Barb Length D	Std. Pkg.	Lbs. per 100 pcs.
2780402C		1/8-27	1.39	1/2	2	.77	100	3.1
2780404C	1/4	1/4-18	1.47	11/16	2	.77	50	5.9
2780406C		3/8-18	1.40	11/16	2	.77	50	8.5
2780604C		1/4-18	1.61	11/16	2	.92	50	7.3
2780606C	3/8	3/8-18	1.75	13/16	2	.92	50	9.1
2780608C		1/2-14	1.79	15/16	2	.97	25	10.5
2780808C	1/2	1/2-14	1.88	15/16	2	1.02	50	11.7
2780812C		3/4-14	2.36	1-3/16	2	1.02	25	18.0
2781012C	5/8	3/4-14	2.36	1-3/16	3	1.50	25	19.4
2781212C	3/4	3/4-14	2.36	1-3/16	3	1.50	20	21.3

- Add a 'BC' suffix to the part number for the brass cap option.

280 Series

**NPSM - FEMALE
SWIVEL HOSE BARB**

National Pipe Straight - Gasket Seat Type

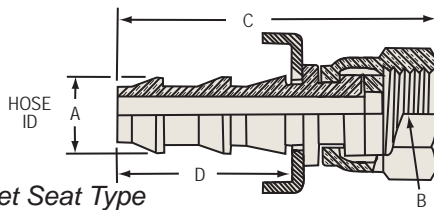

Part Number	Hose ID A	NPSM Thread B	Length C	Hex	No. of Barbs	Barb Length D	Std. Pkg.	Lbs. per 100 pcs.
2800402C	1/4	1/8-27	1.39	1/2	2	.77	100	2.9
2800404C		1/4-18	1.47	11/16	2	.77	100	5.4
2800604C		1/4-18	1.61	11/16	2	.92	50	7.0
2800606C	3/8	3/8-18	1.75	13/16	2	.92	50	8.6
2800608C		1/2-14	1.80	15/16	2	.92	50	9.4
2800808C	1/2	1/2-14	1.88	15/16	2	1.02	25	10.8
2801008C	5/8	1/2-14	2.36	15/16	3	1.50	25	17.8
2801212C	3/4	3/4-14	2.36	1-3/16	3	1.50	20	18.3

- Add a 'BC' suffix to the part number for the brass cap option.
- **Not recommended for use with water**

282 Series

**MALE HOSE BARB
45° SAE**

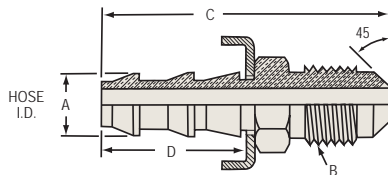

Part Number	Hose ID A	Tube OD	UNF Thread B	Length C	Hex	Number of Barbs	Barb Length D	Std. Pkg.	Lbs. per 100 pcs.
2820407C	1/4	1/4	7/16-20	1.50	7/16	2	.77	100	3.0
2820408C		5/16	1/2-20	1.59	1/2	2	.77	100	4.0
2820610C	3/8	3/8	5/8-18 *	1.83	5/8	2	.92	50	7.4
2820812C	1/2	1/2	3/4-16	2.12	3/4	2	1.02	50	11.5
2821014C	5/8	5/8	7/8-14	2.73	7/8	3	1.50	25	19.4
2821217C	3/4	3/4	1 - 1/16-14 *	2.98	1-1/16	3	1.50	25	32.0

- * Notch in hex for SAE identification
- Add a 'BC' suffix to the part number for the brass cap option.

284 Series

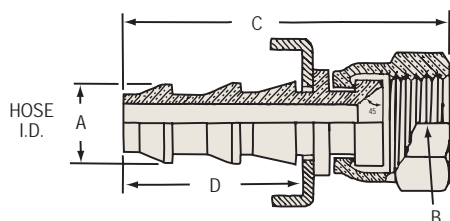
**FEMALE SWIVEL
HOSE BARB**
45° SAE

Part Number	Hose ID A	Tube OD	UNF Thread B	Length C	Hex	Number of Barbs	Barb Length D	Std. Pkg.	Lbs. per 100 pcs.
2840410C	1/4	3/8	5/8-18 *	1.60	3/4	2	.77	50	6.6
2840510C	5/16	3/8	5/8-18 *	1.60	3/4	2	.77	50	6.7
2840610C	3/8	3/8	5/8-18 *	1.75	3/4	2	.92	50	7.1
2841217C	3/4	3/4	1 - 1/16-14 *	2.54	1-1/4	3	1.50	10	26.7

* Notch in nut for SAE identification

• Add a 'BC' suffix to the part number for the brass cap option. Not available for 5/16" I.D. hose size.

286 Series

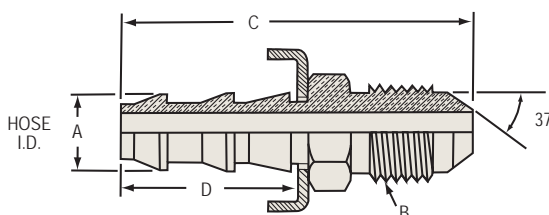
MALE HOSE BARB
37° JIC

Part Number	Hose ID A	Tube OD	UNF Thread B	Length C	Hex	Number of Barbs	Barb Length D	Std. Pkg.	Lbs. per 100 pcs.
2860407C		1/4	7/16-20	1.59	1/2	2	.77	100	3.4
2860408C	1/4	5/16	1/2-20	1.59	5/8	2	.77	50	4.6
2860409C		3/8	9/16-18	1.63	5/8	2	.77	100	5.1
2860609C	3/8	3/8	9/16-18	1.78	5/8	2	.92	50	5.9
2860812C	1/2	1/2	3/4-16	1.98	7/8	2	1.02	25	11.8
2861014C	5/8	5/8	7/8-14	2.62	15/16	3	1.50	25	18.5
2861217C	3/4	3/4	1 - 1/16-12 *	2.79	1-1/8	3	1.50	10	29.0

* UN Thread

• Add a 'BC' suffix to the part number for the brass cap option.

287 Series

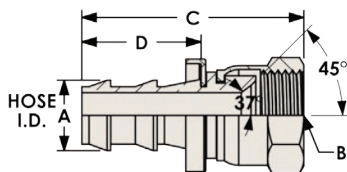
**FEMALE SWIVEL
HOSE BARB**
45° SAE / 37° JIC (dual angle seat)

Part Number	303 SS	Hose ID A	Tube OD	UNF Thread B	Length C	Hex	No. of Barbs	Barb Length D	Std. Pkg.	Lbs. per 100 pcs.
2870407C	SS	1/4	1/4	7/16-20	1.50	9/16	2	.77	100 *	3.8
2870408C		5/16	5/16	1/2-20	1.60	5/8	2	.77	100	5.1
2870608C		3/8	5/16	1/2-20	1.75	5/8	2	.92	25	7.1
2870612C		1/2	1/2	3/4-16	1.82	7/8	2	.92	25	9.0
2870812C	SS	1/2	1/2	3/4-16	1.93	7/8	2	1.02	25 *	10.7
2870814C		5/8	5/8	7/8-14	1.99	1	2	1.02	25	12.8
2871014C		5/8	5/8	7/8-14	2.47	1	3	1.50	25	17.4
2871214C		3/4	5/8	7/8-14	2.47	1	3	1.50	25	24

• Add a 'BC' suffix to the part number for the brass cap option.

* 287-SS are packaged to order

288 Series

FEMALE SWIVEL HOSE BARB
37°

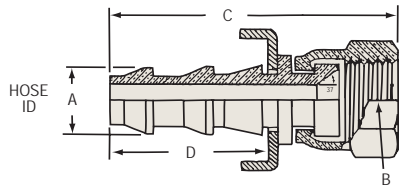

Part Number	303 SS	Hose ID A	Tube OD	UNF Thread B	Length C	Hex	No. of Barbs	Barb Length D	Std. Pkg.	Lbs. per 100 pcs.
2880409C		1/4	3/8	9/16-18	1.60	11/16	2	.77	50	5.3
2880509C		5/16	3/8	9/16-18	1.60	11/16	2	.82	50	5.8
2880609C	SS	3/8	3/8	9/16-18	1.75	11/16	2	.92	50 *	6.5
2880809C		1/2	3/8	9/16-18	1.85	11/16	2	1.02	25	9.4
2881217C	SS	3/4	3/4	1 - 1/16-12 **	2.53	1-1/4	3	1.50	10 *	25.9
2881621C	SS	1	1	1 - 5/16-12 **	2.67	1-7/16	3	1.50	10 *	32.5

• Add a 'BC' suffix to the part number for the brass cap option. Not available for 5/16" I.D. hose size.

* 288-SS are packaged to order

** UN Thread

289 Series

FEMALE SWIVEL 90° ELBOW
37° JIC / 45° SAE - PLATED STEEL

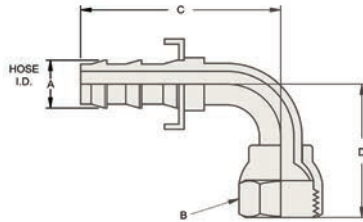

Part Number	Hose ID A	Tube OD	UNF Thread B	Length Centerline C	Length Centerline D	No. of Barbs	Std. Pkg.	Lbs. per 100 pcs.
2890407C +	1/4	1/4	7/16-20	1.55	.83	2	25	5.6
2890407CSAE *		1/4	7/16-20	1.60	.83	2	25	6.4
2890609C +	3/8	3/8	9/16-18	1.85	.91	2	25	10.0
2890610CSAE *		3/8	5/8-18	1.98	.85	2	25	11.2
2890812C +	1/2	1/2	3/4-16	2.33	1.09	2	10	18.1
2891217C +	3/4	3/4	1 - 1/16-12 **	3.26	1.81	3	5	40.0

* Notch in nut for SAE identification

** UN Thread

+ JIC only, may substitute dual angle

290 Series

SAE INVERTED FLARE MALE SWIVEL HOSE BARB

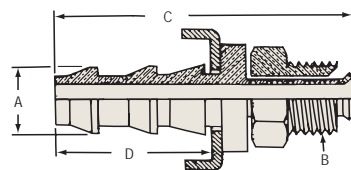

Part Number	Hose ID A	Tube OD	UNF Thread B	Length C	Hex	Number of Barbs	Barb Length D	Std. Pkg.	Lbs. per 100 pcs.
2900406C	1/4	3/16	3/8-24	1.52	7/16	2	.77	100	3.2
2900407C		1/4	7/16-24 *	1.52	7/16	2	.77	100	3.1
2900408C		5/16	1/2-20	1.58	1/2	2	.77	100	3.8
2900508C	5/16	5/16	1/2-20	1.58	1/2	2	.77	50	4.1
2900510C		3/8	5/8-18	1.63	5/8	2	.77	50	6.1
2900608C	3/8	5/16	1/2-20	1.73	1/2	2	.92	100	5.8
2900610C		3/8	5/8-18	1.78	5/8	2	.92	50	7.0
2900812C	1/2	1/2	3/4-18 *	1.96	3/4	2	1.02	50	10.5
2901014C	5/8	5/8	7/8-18 *	2.50	7/8	3	1.50	25	14.9

* UNS Thread

• Add a 'BC' suffix to the part number for the brass cap option. Not available for 5/16" ID hose size.

SAE INVERTED FLARE RIGID FEMALE HOSE BARB

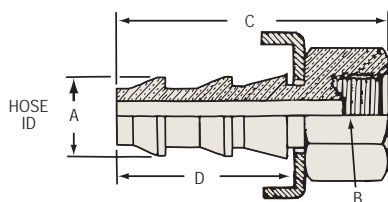

Part Number	Hose ID A	Tube OD	UNF Thread B	Length C	Hex	Number of Barbs	Barb Length D	Std. Pkg.	Lbs. per 100 pcs.
2920406C		3/16	3/8-24	1.17	7/16	2	.77	100	2.3
2920407C	1/4	1/4	7/16-24 *	1.16	1/2	2	.77	100	2.1
2920408C		5/16	1/2-20	1.19	9/16	2	.77	100	2.7
2920508C	5/16	5/16	1/2-20	1.19	9/16	2	.77	100	3.9
2920608C	3/8	5/16	1/2-20	1.34	9/16	2	.92	100	4.4
2920610C	3/8	3/8	5/8-18	1.39	3/4	2	.92	50	5.4
2920812C	1/2	1/2	3/4-18 *	1.54	7/8	2	1.02	25	7.8

- * UNS Thread
- Add a 'BC' suffix to the part number for the brass cap option.

RIGID TUBE SHANK HOSE BARB

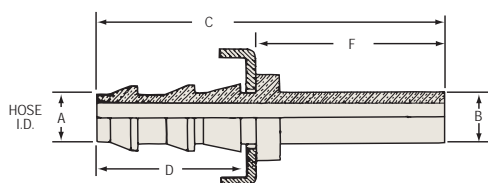

Part Number	303 SS	Hose ID A	Tube OD B	Length C	Tube Length F	No. of Barbs	Barb Length D	Std. Pkg.	Lbs. per 100 pcs.
2940403C			3/16	1.68	.86	2	.77	100	1.9
2940404C	SS	1/4	1/4	1.88	1.06	2	.77	100 *	1.8
2940405C			5/16	1.88	1.06	2	.77	100	2.6
2940606C	SS	3/8	3/8	2.03	1.06	2	.92	50 *	3.5
2940808C	SS	1/2	1/2	2.13	1.06	2	1.02	50 *	5.9
2941010C		5/8	5/8	2.61	1.06	3	1.50	25	9.7
2941212C	SS	3/4	3/4	2.61	1.06	3	1.50	25 *	25.3

- * 294-SS packaged to order
- Add a 'BC' suffix to the part number for the brass cap option.

HOSE SPLICER

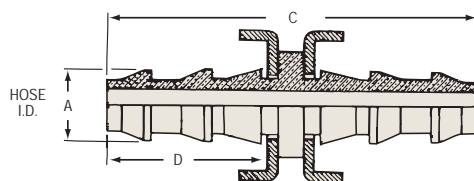

Part Number	303 SS	Hose ID A	Length C	No. of Barbs	Barb Length D	Barb Std. Pkg.	Lbs. per 100 pcs.
2960404C	SS	1/4	1.73	2	.77	100 *	2.5
2960505C		5/16	1.73	2	.77	100	3.4
2960606C	SS	3/8	2.05	2	.92	50 *	7.5
2960808C	SS	1/2	2.25	2	1.02	50 *	7.5
2961010C		5/8	3.21	3	1.50	20	12.4
2961212C		3/4	3.21	3	1.50	15	15.4
2961616C		1	3.21	3	1.50	10	28.7

- Add a 'BC' suffix to the part number for the brass cap option. Not available for 5/16" I.D. hose size.
- * 296-SS are packaged to order

Brass Pipe Fittings

163 Series

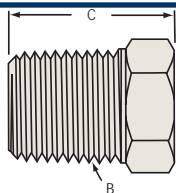

HEX HEAD PLUG

NPT- Part is hollow

Part Number	NPT Thread B	Overall Length C	Hex	Std. Pkg.	Lbs. per 100 pcs.
1630200C	1/8-27	.56	7/16	50	1.7
1630400C	1/4-18	.63	9/16	100	3.4
1630600C	3/8-18	.78	11/16	25	5.1
1630800C	1/2-14	.97	7/8	25	8.0
1631200C	3/4-14	1.06	1-1/16	25	14.1
1631600C	1 - 11-1/2	1.35	1-3/8	10	28.0

165 Series

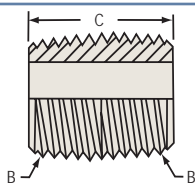

CLOSE PIPE NIPPLE

NPT

Part Number	NPT Thread B	Length C	Flow Diameter	Std. Pkg.	Lbs. per 100 pcs.
1650202C	1/8-27	.75	.250	50	1.0
1650404C	1/4-18	.88	.375	50	2.0
1650606C	3/8-18	1.00	.500	100	3.4
1650808C	1/2-14	1.12	.625	25	5.5
1651212C	3/4-14	1.31	.750	25	11.3
1651616C	1 - 11-1/2	1.75	.935	25	15.6

166 Series

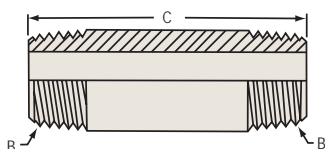

LONG PIPE NIPPLE

NPT

Part Number	NPT Thread B	Length C	Flow Diameter	Std. Pkg.	Lbs. per 100 pcs.
1660215C	1/8-27	1.50	.256	25	2.6
1660220C		2.00	.250	25	3.8
1660225C		2.50	.250	25	4.9
1660230C		3.00	.256	25	6.8
1660235C		3.50	.256	10	6.9
1660240C		4.00	.256	10	7.7
1660415C	1/4-18	1.50	.375	25	4.4
1660420C		2.00	.375	25	5.9
1660425C		2.50	.375	25	8.4
1660430C		3.00	.375	25	10.1
1660435C		3.50	.375	10	11.9
1660440C		4.00	.375	10	13.7
1660450C		5.00	.375	5	17.6
1660615C		3/8-18	1.50	.500	25
1660620C	2.00		.500	25	8.7
1660625C	2.50		.500	10	11.7
1660630C	3.00		.500	10	14.0
1660635C	3.50		.500	10	16.6
1660640C	4.00		.500	5	19.2

• The last two digits of the part number represent the overall length.

166 Series

LONG PIPE NIPPLE
NPT (continued)

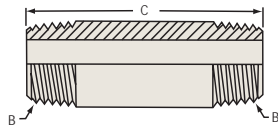

Part Number	NPT Thread B	Length C	Flow Diameter	Std. Pkg.	Lbs. per 100 pcs.
1660815C	1/2-14	1.50	.625	10	9.4
1660820C		2.00	.625	10	12.7
1660825C		2.50	.625	10	16.3
1660830C		3.00	.625	10	20.2
1660835C		3.50	.625	10	23.8
1660840C		4.00	.625	5	27.6
1661220C	3/4-14	2.00	.840	5	17.9
1661225C		2.50	.840	5	23.1
1661230C		3.00	.840	5	28.0
1661235C		3.50	.840	5	32.9

• The last two digits of the part number represent the overall length.

169 Series

90° MALE PIPE ELBOW- Forged
NPTF - Dryseal

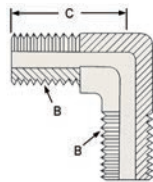

Part Number	NPTF Thread B	Length Centerline C	Std. Pkg.	Lbs. per 100 pcs.
1690202C	1/8-27	.70	25	3.7
1690404C	1/4-18	.83	25	6.6
1690606C	3/8-18	.94	25	8.7
1690808C	1/2-14	1.10	25	16.5

172 Series

MALE UNION
NPSM to NPTF

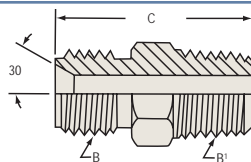

Part Number	NPSM Thread B	NPTF Thread B'	Length C	Hex	Std. Pkg.	Lbs. per 100 pcs.
1720202C	1/8	1/8-27	.94	7/16	100	2.5
1720402C	1/4	1/8-27	1.06	9/16	100	3.9
1720404C		1/4-18	1.25	9/16	100	5.1
1720604C	3/8	1/4-18	1.28	11/16	100	6.5
1720606C		3/8-18	1.30	11/16	50	8.1
1720608C		1/2-14	1.47	7/8	50	13.0
1720806C	1/2	3/8-18	1.35	7/8	50	10.5
1720808C		1/2-14	1.53	7/8	50	13.1
1721212C	3/4	3/4-14	1.53	1-1/16	25	18.8

174 Series

ADAPTER
NPSM to NPTF

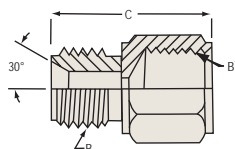

Part Number	NPSM Thread B	NPTF Thread B'	Length C	Hex	Std. Pkg.	Lbs. per 100 pcs.
1740404C	1/4	1/4	1.12	5/8	100	5.6
1740606C	3/8	3/8	1.15	3/4	50	6.9
1740808C	1/2	1/2	1.22	15/16	50	10.6

176 Series

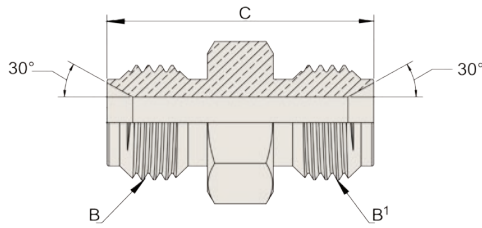

MALE UNION
NPSM to NPSM

Part Number	NPSM Thread B	NPSM Thread B'	Length C	Hex	Std. Pkg.	Lbs. per 100 pcs.
1760202C	1/8	1/8	.79	7/16	100	2.0
1760404C	1/4	1/4	1.09	9/16	100	4.2
1760606C	3/8	3/8	1.19	11/16	100	7.2
1760808C	1/2	1/2	1.31	7/8	50	10.4

207BH Series

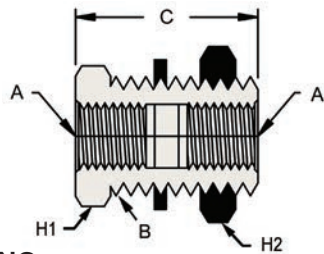

BULKHEAD ANCHOR COUPLING
Washer Nut is 12L14 Steel

Part Number	NPTF Pipe Thread A	UNS Straight Thread B	Hex H1	Hex H2	Length C	Std. Pkg.	Lbs. per 100 pcs.
207BH2	1/8-27	5/8-18	7/8	15/16	1.50	25	16.3
207BH4	1/4-18	3/4-16	1	1	1.50	25	19.4
207BH4S		3/4-16	1	1	.94	25	15.0
207BH6	3/8-18	1-14	1-1/8	1-1/4	1.31	10	27.5
207BH8	1/2-14	1-1/8-14	1-1/4	1-3/8	1.50	10	33.1
207BH12	3/4-14	1-5/16-12	1-1/2	1-1/2	1.50	10	41.3

211 Series

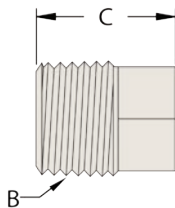

SQUARE HEAD PLUG
PTF-SAE Short- Lead Free per NSF/ANSI 372

Part Number	PTF-SAE Thread B	Length C	Square	Std. Pkg.	Lbs. per 100 pcs.
2110200C	1/8-27	.59	9/32	50	2.0
2110400C	1/4-18	.80	3/8	100	3.0
2110600C	3/8-18	.83	7/16	25	6.0
2110800C	1/2-14	1.07	9/16	25	13.0
2111200C	3/4-14	1.14	5/8	25	20.0

PIPE CAP
NPT

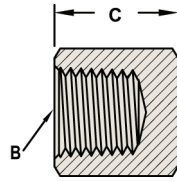

Part Number	NPT Thread B	Length C	Hex	Std. Pkg.	Lbs. per 100 pcs.
2130200C	1/8-27	.50	9/16	50	3.0
2130400C ¹	1/4-18	.63	5/8	100	4.0
2130600C ¹	3/8-18	.63	13/16	25	6.0
2130800C ¹	1/2-14	.87	1	25	8.0
2131200C	3/4-14	.89	1-3/16	25	16.0

¹ Lead Free per NSF/ANSI 372

HEX SOCKET PLUG

NPTF - Lead Free per NSF/ANSI 372

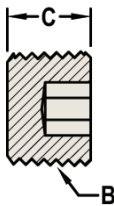

Part Number	NPTF Thread B	Length C	Hex	Std. Pkg.	Lbs. per 100 pcs.
2190200C	1/8-27	.30	3/16	50	1.0
2190400C	1/4-18	.46	1/4	100	2.0
2190600C	3/8-18	.46	5/16	25	3.0
2190800C	1/2-14	.61	3/8	25	5.0
2191200C	3/4-14	.62	9/16	25	10.0

FEMALE PIPE CROSS- Extruded

NPTF - Dryseal

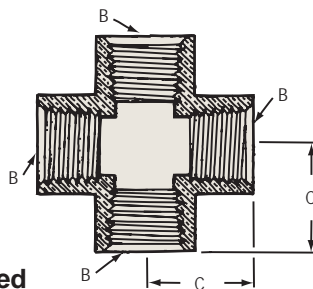

Part Number	NPTF Thread B	C	Std. Pkg.	Lbs. per 100 pcs.
2280202C	1/8-27	.57	25	9.6
2280404C	1/4-18	.78	25	19.5
2280606C	3/8-18	.84	25	26.7
2280808C	1/2-14	1.07	10	54.2
2281212C	3/4-14	1.16	10	72.1

302 Series

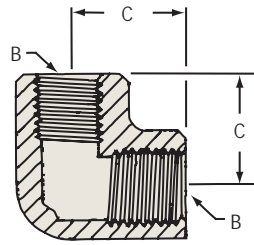

90° FEMALE PIPE ELBOW- Extruded
NPTF - Dryseal
Ref. SAE 130238

Part Number	NPTF Thread B	C	Std. Pkg.	Lbs. per 100 pcs.
3020202C	1/8-27	.55	25	6.3
3020404C	1/4-18	.78	25	14.8
3020606C	3/8-18	.84	25	20.0
3020808C	1/2-14	1.09	25	38.6
3021212C	3/4-14	1.16	10	58.1

304 Series

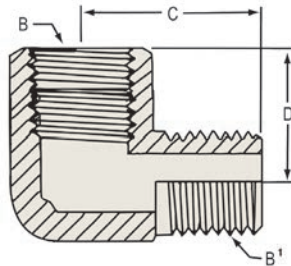

FULL PATTERN 90° STREET ELBOW- Extruded
NPTF - Dryseal
Ref. SAE 130239

Part Number	NPTF Thread B	NPTF Thread B'	C	D	Std. Pkg.	Lbs. per 100 pcs.
3040202C	1/8-27	1/8-27	.66	.48	25	4.9
3040402C	1/4-18	1/8-27	.72	.45	25	11.3
3040404C	1/4-18	1/4-18	.91	.72	25	12.0
3040604C	3/8-18	1/4-18	1.25	.78	25	14.4
3040606C	3/8-18	3/8-18	.97	.78	25	16.4
3040806C	1/2-14	3/8-18	1.25	.97	25	32.3
3040808C	1/2-14	1/2-14	1.24	1.09	25	37.3
3041208C	3/4-14	1/2-14	1.39	1.10	25	50.3
3041212C	3/4-14	3/4-14	1.38	1.12	10	51.9

306 Series

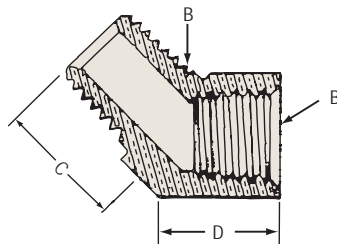

45° STREET ELBOW- Extruded
NPTF - Dryseal
Ref. SAE 130339

Part Number	NPTF Thread B	C	D	Std. Pkg.	Lbs. per 100 pcs.
3060202C	1/8-27	.50	.38	25	3.7
3060404C	1/4-18	.72	.56	25	7.6
3060606C	3/8-18	.72	.56	25	11.9
3060808C	1/2-14	1.00	.75	25	25.8
3061212C	3/4-14	1.06	.75	10	34.1

FEMALE PIPE TEE- Extruded
NPTF - Dryseal
 Ref. SAE 130438

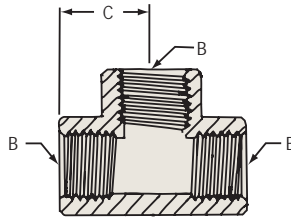

Part Number	NPTF Thread B	C	Std. Pkg.	Lbs. per 100 pcs.
3220202C	1/8-27	.55	25	7.7
3220404C	1/4-18	.78	25	19.1
3220606C	3/8-18	.84	25	23.2
3220808C	1/2-14	1.09	25	47.1
3221212C	3/4-14	1.16	10	65.3

MALE BRANCH TEE- Extruded
NPTF - Dryseal
 Ref. SAE 130425

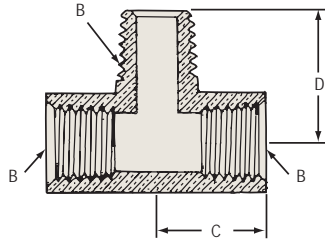

Part Number	NPTF Thread B	C	D	Std. Pkg.	Lbs. per 100 pcs.
3240202C	1/8-27	.55	.66	25	6.4
3240404C	1/4-18	.78	.91	25	16.1
3240606C	3/8-18	.84	.97	25	22.3
3240808C	1/2-14	1.09	1.25	25	42.4
3241212C	3/4-14	1.09	1.25	10	58.0

STREET TEE- Extruded
NPTF - Dryseal
 Ref. SAE 130424

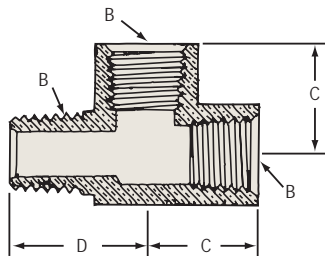

Part Number	NPTF Thread B	C	D	Std. Pkg.	Lbs. per 100 pcs.
3260202C	1/8-27	.55	.73	25	6.3
3260404C	1/4-18	.78	.91	25	15.8
3260606C	3/8-18	.84	.97	25	21.6
3260808C	1/2-14	1.09	1.28	25	44.3
3261212C	3/4-14	1.09	1.38	10	59.1

370 Series

MALE HEX NIPPLE

NPTF - Dryseal
Ref. SAE 130137

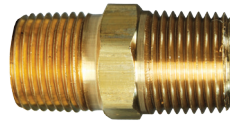
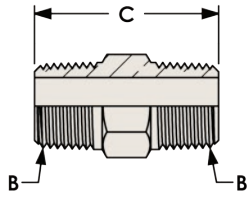

Part Number	NPTF Thread B	Length C	Hex	Std. Pkg.	Lbs. per 100 pcs.
3700202C	1/8-27	.97	7/16	100	2.5
3700404C	1/4-18	1.38	9/16	100	5.4
3700606C	3/8-18	1.41	11/16	50	7.7
3700808C	1/2-14	1.81	7/8	25	14.4
3701212C	3/4-14	1.75	1-1/16	20	21.4
3701616C	1 - 11-1/2	2.24	1-3/8	10	40.0

371 Series

FEMALE HEX COUPLING

NPTF - Dryseal
Ref. SAE 130138

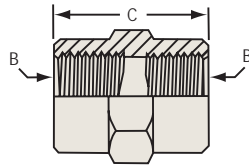

Part Number	NPTF Thread B	Length C	Hex	Std. Pkg.	Lbs. per 100 pcs.
3710202C	1/8-27	.75	9/16	25	3.3
3710404C	1/4-18	1.12	3/4	25	8.8
3710606C	3/8-18	1.12	7/8	25	10.4
3710808C	1/2-14	1.50	1-1/16	25	19.9
3711212C	3/4-14	1.57	1-3/8	10	37.2

373 Series

REDUCER BUSHING

NPTF - Dryseal
Ref. SAE 130140

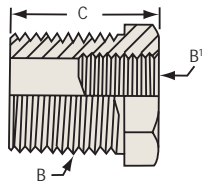

Part Number	NPTF Thread B External	NPTF Thread B' Internal	Length C	Hex	Std. Pkg.	Lbs. per 100 pcs.
3730402C	1/4-18	1/8-27	.75	9/16	100	2.6
3730602C	3/8-18	1/8-27	.75	11/16	100	5.3
3730604C		1/4-18	.75	3/4	100	4.0
3730802C	1/2-14	1/8-27	1.00	7/8	25	12.9
3730804C		1/4-18	1.00	7/8	50	10.4
3730806C		3/8-18	1.00	7/8	50	7.3
3731202C *	3/4-14	1/8-27	.94	1-1/16	25	21.6
3731204C		1/4-18	1.00	1-1/8	25	20.5
3731206C		3/8-18	1.00	1-1/8	25	22.1
3731208C		1/2-14	1.00	1-1/8	25	12.5
3731604C *	1-11-1/2	1/4-18	1.12	1-3/8	10	48.7
3731606C *		3/8-18	1.12	1-7/16	10	43.7
3731608C		1/2-14	1.12	1-7/16	10	37.2
3731612C		3/4-14	1.12	1-7/16	10	27.0

* SAE does not provide a standard for these sizes.

ADAPTER
NPTF - Dryseal
Ref. SAE 130139

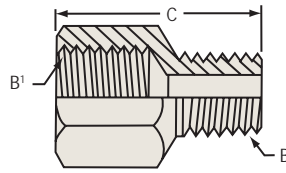

Part Number	NPTF Thread B' Internal	NPTF Thread B External	Length C	Hex	Std. Pkg.	Lbs. per 100 pcs.
3750202C	1/8-27	1/8-27	.88	9/16	100	3.6
3750402C	1/4-18	1/8-27	1.06	3/4	50	7.3
3750404C		1/4-18	1.25	3/4	50	8.8
3750602C	3/8-18	1/8-27	1.07	7/8	50	7.4
3750604C		1/4-18	1.25	7/8	50	10.2
3750606C		3/8-18	1.25	7/8	50	10.6
3750804C	1/2-14	1/4-18	1.47	1-1/16	25	9.8
3750806C		3/8-18	1.47	1-1/16	25	18.3
3750808C		1/2-14	1.66	1-1/16	25	20.6
3751206C		3/4-14	3/8-18	1.50	1-3/8	10
3751208C	1/2-14		1.69	1-3/8	10	33.2
3751212C	3/4-14		1.69	1-3/8	10	34.3

REDUCER COUPLER
NPTF - Dryseal (double female)
Ref. SAE 130138

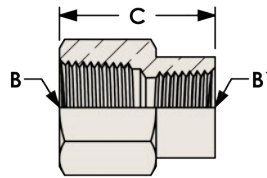

Part Number	NPTF Thread B	NPTF Thread B'	Length C	Hex	Std. Pkg.	Lbs. per 100 pcs.
3770402C	1/4-18	1/8-27	.97	3/4	50	7.5
3770602C	3/8-18	1/8-27	1.00	7/8	50	5.7
3770604C		1/4-18	1.16	7/8	50	11.6
3770804C	1/2-14	1/4-18	1.28	1-1/16	25	13.3
3770806C		3/8-18	1.38	1-1/16	10	20.1
3771206C	3/4-14	3/8-18	1.38	1-3/8	10	18.4
3771208C		1/2-14	1.50	1-3/8	10	23.1

MALE REDUCING HEX NIPPLE
NPTF - Dryseal
Ref. SAE 130137

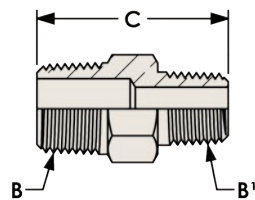

Part Number	NPTF Thread B	NPTF Thread B'	Length C	Hex	Std. Pkg.	Lbs. per 100 pcs.
3790402C	1/4-18	1/8-27	1.19	9/16	100	4.5
3790602C	3/8-18	1/8-27	1.22	11/16	50	6.3
3790604C		1/4-18	1.41	11/16	50	7.4
3790804C	1/2-14	1/4-18	1.62	7/8	50	10.5
3790806C		3/8-18	1.62	7/8	50	12.3
3791208C	3/4-14	1/2-14	1.80	1-1/16	25	18.9

Garden Hose Fittings and Accessories

500 Series



ACCESSORIES - BAR STOCK

Part Number	Description
500BFP	back flow preventer

Features:

- **125 max PSI**
- Working Temperature **33°F - 140°F**
- EPDM gasket
- Stainless steel components

NOZZLES

Part Number	Description
500AN4	4" adjustable nozzle
500AN7	6" adjustable nozzle
500SN2	2" sweeper nozzle, machined brass
500SN6	6" sweeper nozzle, machined brass

ACCESSORIES- Forged

Part Number	Description
500GHV	Forged brass ball valve, 3/4 NH male x female; 140°F - 100 PSI
500GHY	Double Y valve, swivel inlet - with Higbie cut threads (capped) to prevent cross threading; 140°F - 100 PSI
500YC	Y coupler, nickel plated brass; 195°F - 150 PSI
500GH4VBK	GH 4 valve manifold, swivel inlet, black knob; 120°F - 100 PSI

COUPLERS

Part Number	303 SS	Description
500QCF	SS	Female coupler; 140°F - 150 PSI
500QCSG		Garden hose coupler seal gasket: NBR material, 140°F - 150 PSI
500QCFV		Valved coupler, water shutoff; 140°F - 150 PSI
500QCM	SS	Male plug, extended thread; 195°F - 150 PSI
500QCK	SS	Complete assembly; 140°F - 150 PSI
500QCKV		Complete assembly, valved; 140°F - 150 PSI

COMPONENTS

Part Number	Description
5911212F	Filter Washer, 1.00" OD, 304 stainless steel mesh, FDA black PVC duro, 70A
5911212W	Washer, .63" ID, 1.00" OD black 80 duro SBR
5911616W	Washer, .86" ID, 1.27" OD black 60 duro SBR
5861012N	3/4" Garden hose nut round with knurl
5911212N	3/4" Garden hose nut hex with knurl
5911616N	1" Garden hose nut (NPSH) hex with knurl

Note: Hose fittings stem components are also available separately. Contact Dixon Brass for availability and pricing.

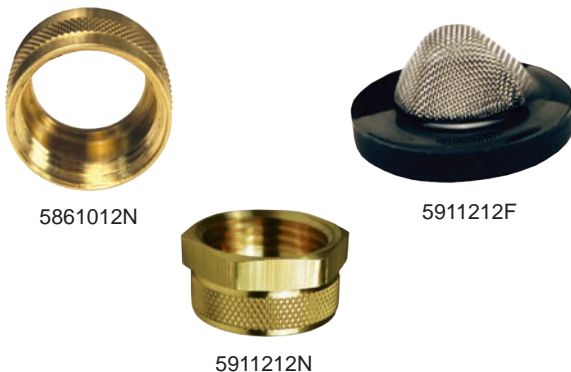
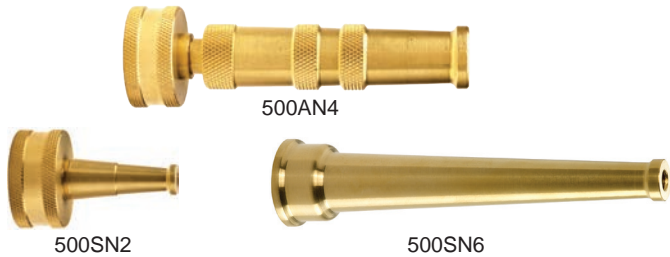

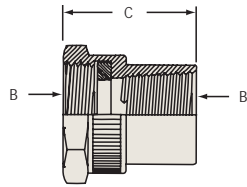

FEMALE HOSE x FEMALE PIPE

Non-swivel NH x NPTF

Part Number	303 SS	NH Thread B	NPTF Thread B ¹	Length C	Hex	Std. Pkg.	Lbs. per 100 pcs.
5011202C			1/8-27	1.02	1-3/16	50	9.9
5011204C			1/4-18	1.12	1-3/16	25	10.4
5011206C		3/4 - 11-1/2	3/8-18	1.18	1-3/16	25	10.6
5011208C	SS		1/2-14	1.32	1-3/16	25 *	12.4
5011212C	SS		3/4-14	1.56	1-3/16	25 *	13.0

* 501-SS threads B¹ are NPT and the parts are packaged to order

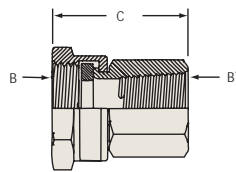

FEMALE HOSE x FEMALE PIPE

Swivel NH x NPTF

Part Number	303 SS	NH Thread B	NPTF Thread B ¹	Length C	Hex	Std. Pkg.	Lbs. per 100 pcs.
5021208C	SS	3/4 - 11-1/2	1/2-14	1.33	1-3/16	25 *	15.4
5021212C	SS		3/4-14	1.59	1-3/16	10 *	22.3

* 502-SS threads B¹ are NPT and the parts are packaged to order

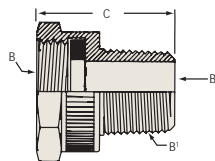

FEMALE HOSE x MALE PIPE

Non-swivel NH x NPTF

Part Number	303 SS	NH Thread B	NPTF Thread B ¹	NPTF Thread B ²	Length C	Hex	Std. Pkg.	Lbs. per 100 pcs.
5031206C			3/8-18	---	1.37	1-3/16	25	11.3
5031208C	SS	3/4 - 11-1/2	1/2-14	---	1.37	1-3/16	25 *	13.0
5031212C	SS		3/4-14	1/2-14	1.37	1-3/16	25 *	14.0

* 503-SS threads B¹ are NPT and the parts are packaged to order

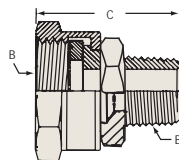

FEMALE HOSE x MALE PIPE

Swivel - Internal and External Hex NH x NPTF

Part Number	303 SS	NH Thread B	NPTF Thread B ¹	Length C	Hex	Std. Pkg.	Lbs. per 100 pcs.
5041204C			1/4-18	1.43	1-3/16	25	12.5
5041206C			3/8-18	1.43	1-3/16	25	15.1
5041208C	SS	3/4 - 11-1/2	1/2-14	1.63	1-3/16	25 *	16.3
5041212C	SS		3/4-14	1.43	1-3/16	20 *	19.4

* 504-SS threads B¹ are NPT and the parts are packaged to order

506 Series

FEMALE HOSE x FEMALE HOSE

Swivel NH x NH

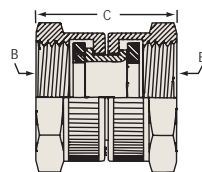

Part Number	NH Thread B	Length C	Hex	Std. Pkg.	Lbs. per 100 pcs.
5061212C	3/4 - 11-1/2	1.32	1-3/16	25	14.1

507 Series

MALE HOSE x FEMALE PIPE

NH x NPTF

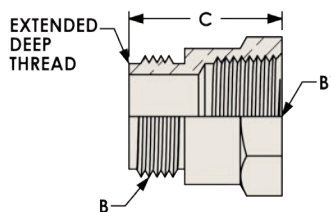

Part Number	303 SS	NH Thread B	NPTF Thread B'	Length C	Hex	Std. Pkg.	Lbs. per 100 pcs.
5071204C		3/4 - 11-1/2	1/4-18	.75	1-1/16	25	13.6
5071206C			3/8-18	.75	1-1/16	25	11.1
5071208C	SS	3/4 - 11-1/2	1/2-14	.75	1-1/16	25 *	7.9
5071212C	SS		3/4-14	1.37	1-3/16	25 *	20.0

* 507-SS threads B' are NPT and the parts are packaged to order

508 Series

MALE HOSE x MALE PIPE

NH x NPTF

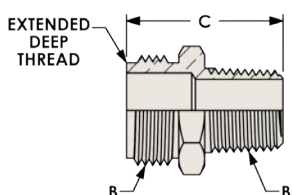

Part Number	303 SS	NH Thread B	NPTF Thread B'	Length C	Hex	Std. Pkg.	Lbs. per 100 pcs.
5081206C		3/4 - 11-1/2	3/8-18	1.31	1-1/16	25	11.9
5081208C			1/2-14	1.50	1-1/16	25 *	13.5
5081212C	SS	3/4 - 11-1/2	3/4-14	1.50	1-1/16	25 *	16.7
5081216C	SS		1 - 11-1/2	1.85	1-3/8	10	22.5

* 508-SS threads B' are NPT and the parts are packaged to order

509 Series

MALE HOSE x MALE HOSE

NH x NH

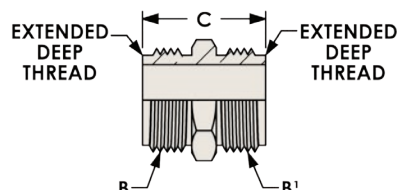

Part Number	303 SS	NH Thread B	NH Thread B'	Length C	Hex	Std. Pkg.	Lbs. per 100 pcs.
5091212C	SS	3/4 - 11-1/2	3/4 - 11-1/2	1.24	1-1/16	25 *	13.1
5091612C		1 - 11-1/2 **	3/4 - 11-1/2	1.43	1-3/8	20	18.9

* 509-SS are packaged to order

** NPSH thread

HOSE CAP

Round

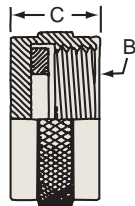

Part Number	NH Thread B	Length C	Std. Pkg.	Lbs. per 100 pcs.
5131212C	3/4 - 11-1/2	.625	25	7.8



303 Stainless Steel

**MALE HOSE x MALE PIPE x
FEMALE PIPE**
NH x NPTF x NPTF

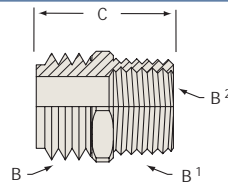

CDA Brass 360

Part Number	303 SS	NH Thread B	NPTF Thread B ¹	NPTF Thread B ²	Length C	Hex	Std. Pkg.	Lbs. per 100 pcs.
5141212C	SS	3/4 - 11-1/2	3/4-14	1/2-14	1.50	1-1/16	25*	16

* 514-SS threads are NPT and the parts are packaged to order

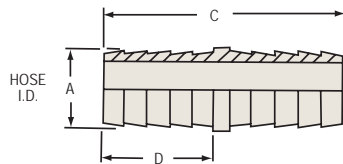

GARDEN HOSE MENDER

Part Number	Hose ID A	Length C	No. of Barbs	Barb Length D	Std. Pkg.	Lbs. per 100 pcs.
5780808C	1/2	2.06	4	.97	50	6.5
5781010C	5/8	2.06	4	.97	50	8.6
5781212C	3/4	2.50	4	1.19	20	12.9
5781616C	1	3.00	5	1.44	10	22.5

Note: See page 8 for stainless steel menders

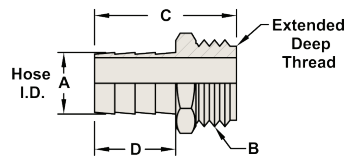

**SHORT SHANK
MALE GARDEN HOSE FITTING**

Part Number	Hose ID A	NH Thread B	Length C	Hex	No. of Barbs	Barb Length D	Std. Pkg.	Lbs. per 100 pcs.
5850812C	1/2	3/4 - 11-1/2	1.75	1-1/16	3	1.00	25	11.0
5851012C	5/8	3/4 - 11-1/2	1.75	1-1/16	3	1.00	25	11.9
5851212C	3/4	3/4 - 11-1/2	1.75	1-1/16	3	1.00	25	13.4

586 Series

SHORT SHANK FEMALE SWIVEL GARDEN HOSE FITTING
(round nut)

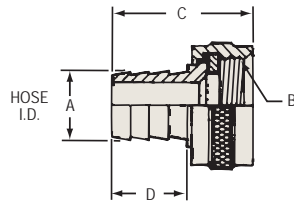

Part Number	Hose ID A	NH Thread B	Length C	No. of Barbs	Barb Length D	Std. Pkg.	Lbs. per 100 pcs.
5860812C	1/2	3/4 - 11-1/2	1.63	3	1.00	25	9.8
5861012C	5/8	3/4 - 11-1/2	1.63	3	1.00	25	10.2
5861212C	3/4	3/4 - 11-1/2	1.63	3	1.00	25	11.5

587 Series

SHORT SHANK GARDEN HOSE FITTING SET *
(round nut)

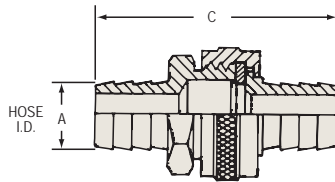

Part Number	Hose ID A	NH Thread B	Length C	No. of Barbs	Std. Pkg.	Lbs. per 100 pcs.
5870808K	1/2	3/4 - 11-1/2	2.95	3	25	20.8
5871010K	5/8	3/4 - 11-1/2	2.95	3	25	22.1
5871212K	3/4	3/4 - 11-1/2	2.95	3	25	25.0

* not assembled

588 Series

SHORT SHANK FEMALE SWIVEL GARDEN HOSE FITTING
(hex nut)

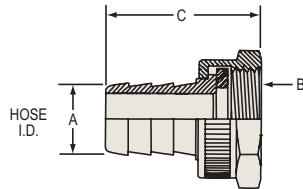

Part Number	Hose ID A	NH Thread B	Length C	No. of Barbs	Barb Length D	Std. Pkg.	Lbs. per 100 pcs.
5880812C	1/2	3/4 - 11-1/2	1.63	3	1.00	25	10.7
5881012C	5/8	3/4 - 11-1/2	1.63	3	1.00	25	10.9
5881212C	3/4	3/4 - 11-1/2	1.63	3	1.00	25	12.1

589 Series

SHORT SHANK GARDEN HOSE FITTING SET *
(hex nut)

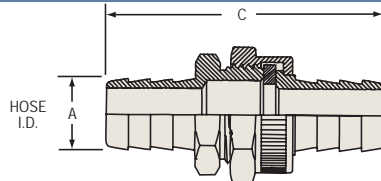

Part Number	Hose ID A (both fittings)	NH Thread B	Length C	No. of Barbs	Std. Pkg.	Lbs. per 100 pcs.
5890808K	1/2	3/4 - 11-1/2	2.95	3	25	21.7
5891010K	5/8	3/4 - 11-1/2	2.95	3	25	22.9
5891212K	3/4	3/4 - 11-1/2	2.95	3	25	25.6

* not assembled

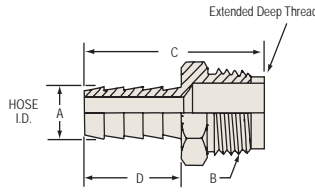

MALE GARDEN HOSE FITTING

Part Number	303 SS	Hose ID A	NH Thread B	Length C	Hex	No. of Barbs	Barb Length D	Std. Pkg.	Lbs. per 100 pcs.
5900612C		3/8	3/4 - 11-1/2	1.94	1-1/16	4	1.19	25	11.3
5900812C	SS	1/2	3/4 - 11-1/2	1.94	1-1/16	4	1.19	25 *	12.3
5901012C	SS	5/8	3/4 - 11-1/2	1.94	1-1/16	4	1.19	25 *	14.5
5901212C	SS	3/4	3/4 - 11-1/2	1.94	1-1/16	4	1.19	25 *	15.1
5901612C		1	3/4 - 11-1/2	1.94	1-1/16	4	1.19	10	21.4
5901616C			1 - 11-1/2 **	2.38	1-3/8	5	1.44	10	25.6

* 590-SS are packaged to order

** NPSH thread - extended

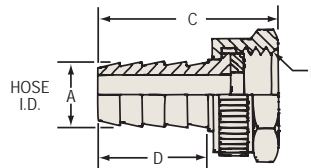

FEMALE SWIVEL GARDEN HOSE FITTING

Part Number	303 SS	Hose ID A	NH Thread B	Length C	Hex	No. of Barbs	Barb Length D	Std. Pkg.	Lbs. per 100 pcs.
5910612C		3/8	3/4 - 11-1/2	1.82	1-3/16	4	1.19	25	11.2
5910812C	SS	1/2	3/4 - 11-1/2	1.82	1-3/16	4	1.19	25 *	11.5
5911012C	SS	5/8	3/4 - 11-1/2	1.82	1-3/16	4	1.19	25 *	12.2
5911212C	SS	3/4	3/4 - 11-1/2	1.82	1-3/16	4	1.19	25 *	13.5
5911612C		1	3/4 - 11-1/2	2.10	1-3/16	4	1.19	10	25.2
5911616C			1 - 11-1/2 **	2.25	1-7/16	5	1.44	10	24.4

* 591-SS are packaged to order

** NPSH thread

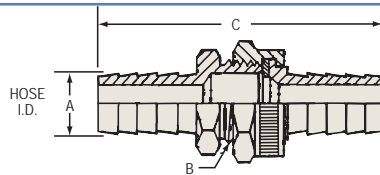

303 Stainless Steel

CDA Brass 360

GARDEN HOSE FITTING SET - not assembled

Part Number	303 SS	Hose ID (both fittings) A	NH Thread B	Length C	No. of Barbs	Std. Pkg.	Lbs. per 100 pcs.
5920606K		3/8	3/4 - 11-1/2	3.32	4	25	22.5
5920808K	SS	1/2	3/4 - 11-1/2	3.32	4	25 *	23.8
5921010K	SS	5/8	3/4 - 11-1/2	3.32	4	25 *	26.7
5921212K	SS	3/4	3/4 - 11-1/2	3.32	4	25 *	28.6
5921612K		1	3/4 - 11-1/2	3.60	4	10	46.7
5921616K			1 - 11-1/2 **	4.19	5	10	50.0

* 592-SS are packaged to order

** NPSH thread

593 Series

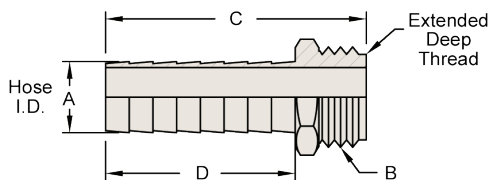

LONG SHANK MALE GARDEN HOSE FITTING

Part Number	Hose ID A	NH Thread B	Length C	Hex	No. of Barbs	Barb Length D	Std. Pkg.	Lbs. per 100 pcs.
5930812C	1/2	3/4 - 11-1/2	2.78	1-1/16	7	2.03	25	13.8
5931012C	5/8	3/4 - 11-1/2	2.78	1-1/16	7	2.03	25	15.1
5931212C	3/4	3/4 - 11-1/2	2.78	1-1/16	7	2.03	10	17.9
5931616C	1	1 - 11-1/2 *	2.96	1- 3/8	7	2.03	5	28.9

* NPSH thread

594 Series

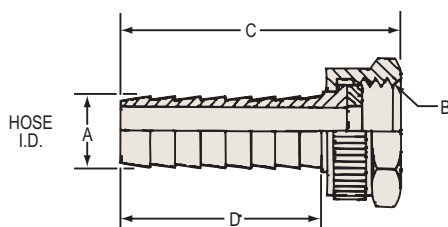

LONG SHANK FEMALE SWIVEL GARDEN HOSE FITTING

Part Number	Hose ID A	NH Thread B	Length C	Hex	No. of Barbs	Barb Length D	Std. Pkg.	Lbs. per 100 pcs.
5940812C	1/2	3/4 - 11-1/2	2.66	1-3/16	7	2.03	25	13.0
5941012C	5/8	3/4 - 11-1/2	2.66	1-3/16	7	2.03	25	14.2
5941212C	3/4	3/4 - 11-1/2	2.66	1-3/16	7	2.03	10	16.7
5941616C	1	1 - 11-1/2 *	2.84	1-7/16	7	2.03	5	28.8

* NPSH thread

595 Series

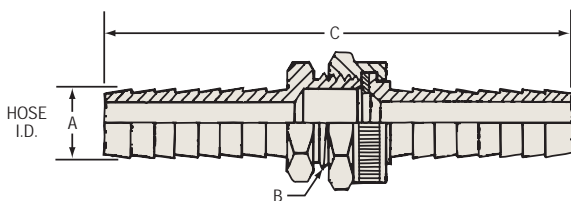

LONG SHANK GARDEN HOSE FITTING SET **

Part Number	Hose ID A (both fittings)	NH Thread B	Length C	No. of Barbs	Std. Pkg.	Lbs. per 100 pcs.
5950808K	1/2	3/4 - 11-1/2	5.05	7	25	26.9
5951010K	5/8	3/4 - 11-1/2	5.05	7	25	29.3
5951212K	3/4	3/4 - 11-1/2	5.05	7	10	34.6
5951616K	1	1 - 11-1/2 *	5.20	7	5	57.6

* NPSH thread

** Not assembled

Features:

- Even spray valve mist provides the proper moisture on paper roll ends
- Helps eliminate wrinkles and folder delivery problems, increasing pressroom production and reducing waste
- A slight flex of the hose in any direction (360°) activates the spray.
- Quick action with no protruding levers, thumb depressors, triggers or other devices utilized
- Positive water seal when hose is released causes the internal valve to close and immediately shut off spray.
- Sealed mechanism with no packing gland

833 Series



valve with hook

Female NPT Size	Description	Part #
1/4"	valve, no hook	83304
3/8"	valve, no hook	83306
1/4"	valve, with hook	83304H
3/8"	valve, with hook	83306H

832 Series



Spray Valve Hose Assembly

Part Number	Male NPT Inlet	Description
8320605	3/8"	3/8" ID, 5' Hose
8320606	3/8"	3/8" ID, 6' Hose
8320608	3/8"	3/8" ID, 8' Hose
8320610	3/8"	3/8" ID, 10' Hose
8320612	3/8"	3/8" ID, 12' Hose
8320615	3/8"	3/8" ID, 15' Hose
8320605H	3/8"	3/8" ID, 5' Hose with hook
8320606H	3/8"	3/8" ID, 6' Hose with hook
8320608H	3/8"	3/8" ID, 8' Hose with hook
8320610H	3/8"	3/8" ID, 10' Hose with hook
8320612H	3/8"	3/8" ID, 12' Hose with hook
8320615H	3/8"	3/8" ID, 15' Hose with hook

Grease Whip Hose Assemblies and Couplings

GWH Series



Features:

- One piece brass crimp couplings
- 1/8-27 male NPT thread, solid base
- US manufactured to 3/16" ID hose - meets SAE100R1-AT; working pressure of **3000 PSI**
- For use with hand grease guns only
- Available with optional retail packaging or strain relief spring

HOSE ASSEMBLIES

Part Number	Assembly Length	Strain Relief Spring	Retail Pack	Std. Pkg.
GWH0800	8"	Add 'S' suffix to part number		Per customer requirement
GWH1200	12"	Add 'S' suffix to part number	Add 'R' suffix to part number	
GWH1800	18"	Add 'S' suffix to part number	Add 'R' suffix to part number	
GWH2400	24"	Add 'S' suffix to part number		
GWH3600	36"	Add 'S' suffix to part number		
GWH4800	48"	Add 'S' suffix to part number		
GWH6000	60"	Add 'S' suffix to part number		

For lengths not listed, call for quote (50 minimum)

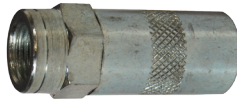

COUPLER and FITTINGS

Part Number	Description	Material	Retail Pack	Std. Pkg.
GWHC	Grease hose coupler with ball check - valved shutoff	Zinc Plated Steel	Add 'R' suffix to part number	10
GWHC-FF	Grease hose coupler - Full Flow	Zinc Plated Steel	Add 'R' suffix to part number	10
0010055C	1/8-27 male NPT thread, drilled and chamfered base	Brass		100
0010260C	1/8-27 male NPT thread, solid base	Brass		100
0010860C	1/8-27 female NPT thread	Brass		100



GWHZ000
GWHZ400

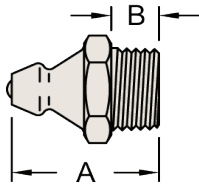

GWHZ045
GWHZ445

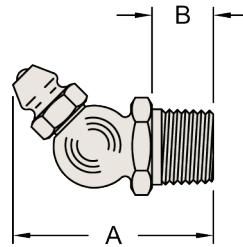

GWHZ090
GWHZ490

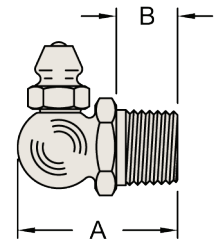

GWHZ- ZERK FITTINGS Zinc Plated Steel

Part Number	Description	Thread	A Overall Length	B Thread Length	Hex	Std. Pkg	Lbs. per 100 pcs.
GWHZ000	Ball check	1/8-27 NPT	.66	.26	.43	100	1.00
GWHZ045	45° Angle ball check	1/8-27 NPT	.86	.28	.43	100	1.00
GWHZ090	90° Angle ball check	1/8-27 NPT	.83	.31	.43	100	1.00
GWHZ400	Ball check	1/4-28 Tapered SAE-LT	.53	.20	.312	100	1.00
GWHZ445	45° Angle ball check	1/4-28 Tapered SAE-LT	.80	.20	.375	100	1.00
GWHZ490	90° Angle ball check	1/4-28 Tapered SAE-LT	1.20	.20	.375	100	1.00

All items available in retail packs of 10 - Add R to part number: Order 1 for 1 Retail Pack of 10 pcs.

Compression Fittings

60 Series

SLEEVE 60C

Reference SAE 060115

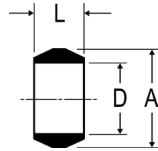

Part Number	Tube Size	A	D	L	Std. Pkg.
60C-02	1/8	.187	.130	.19	100
60C-03	3/16	.266	.192	.22	100
60C-04	1/4	.344	.255	.25	100
60C-05	5/16	.406	.318	.25	100
60C-06	3/8	.469	.382	.25	100
60C-07	7/16	.531	.444	.31	100
60C-08	1/2	.594	.507	.38	100
60C-10	5/8	.719	.632	.38	100
60C-12	3/4	.875	.758	.44	50
60C-14	7/8	1.000	.883	.41	50

ACETAL SLEEVE 60PT

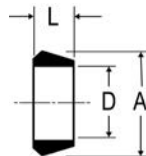

Part Number	Plastic Tube Wall	Tube Wall	A	D	L	Std. Pkg.
60PT-04	1/4	.40	.375	.254	.19	200
60PT-05	5/16	.62	.438	.317	.19	100
60PT-06	3/8	.62	.500	.379	.19	100
60PT-08	1/2	.62	.631	.507	.25	100
60PT-10	5/8	.62	.747	.632	.22	100

NUT 61C

Reference SAE 060110

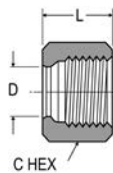

Part Number	Tube Size	Straight Thread	Hex C	D	L	Std. Pkg.
61C-02	1/8	5/16-24	3/8	.130	.38	100
61C-03	3/16	3/8-24	7/16	.192	.41	100
61C-04	1/4	7/16-24	1/2	.255	.44	100
61C-05	5/16	1/2-24	9/16	.318	.44	50
61C-06	3/8	9/16-24	5/8	.382	.47	100
61C-07	7/16	5/8-24	11/16	.444	.50	25
61C-08	1/2	11/16-20	13/16	.507	.62	50
61C-10	5/8	13/16-18	15/16	.632	.62	25
61C-12	3/4	1-18	1-3/16	.758	.69	25
61C-14	7/8	1-1/8-18	1-1/4	.890	.62	25

LONG NUT 61CL

Reference SAE 060111

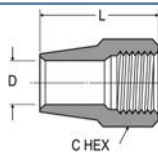

Part Number	Tube Size	Straight Thread	Hex C	D	L	Std. Pkg.
61CL-04	1/4	7/16-24	1/2	.255	.75	10
61CL-05	5/16	1/2-24	9/16	.318	.84	10
61CL-06	3/8	9/16-24	5/8	.382	.97	10
61CL-08	1/2	11/16-20	13/16	.507	1.06	10
61CL-10	5/8	13/16-18	15/16	.632	1.19	10
61CL-12	3/4	1-18	1-3/16	.758	1.38	10

62C Series

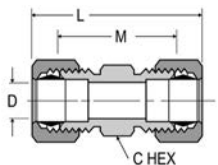

UNION 62C

Reference SAE 060101 BA

Part Number	Tube Size	Straight Thread	Hex C	L	M	Flow Diameter	Std. Pkg.
62C-02	1/8	5/16-24	5/16	1.05	.64	.094	25
62C-03	3/16	3/8-24	3/8	1.21	.72	.125	25
62C-04	1/4	7/16-24	7/16	1.33	.79	.188	50
62C-05	5/16	1/2-24	1/2	1.39	.85	.250	50
62C-06	3/8	9/16-24	9/16	1.52	.97	.312	50
62C-07	7/16	5/8-24	5/8	1.70	1.02	.312	10
62C-08	1/2	11/16-20	11/16	1.90	1.08	.406	25
62C-10	5/8	13/16-18	13/16	2.06	1.23	.500	10
62C-12	3/4	1-18	1	2.37	1.41	.562	10
62C-14	7/8	1-1/8-18	1-1/8	2.07	1.19	.766	10

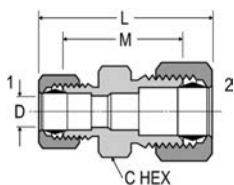

UNION REDUCERS 62C

Reference SAE 060101 BA

Part Number	1 Tube Size	2 Tube Size	1 Str. Thread	2 Str. Thread	Hex C	L	M	Flow Diameter	Std. Pkg.
62C-0403	3/16	1/4	3/8-24	7/16-24	7/16	1.29	.78	.125	10
62C-0604	1/4	3/8	7/16-24	9/16-24	9/16	1.46	.97	.188	10
62C-0806	3/8	1/2	9/16-24	11/16-20	11/16	1.71	1.03	.312	10
62C-1006	3/8	5/8	9/16-24	13/16-18	13/16	1.82	1.13	.312	10

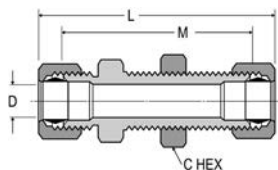

BULKHEAD UNION 62CBH

Part Number	Tube Size	Straight Thread	Hex C	L	M	Flow Diameter	Std. Pkg.
62CBH-04	1/4	7/16-24	9/16	2.29	1.75	.188	10
62CBH-06	3/8	9/16-24	11/16	2.42	1.88	.312	10

63 Series

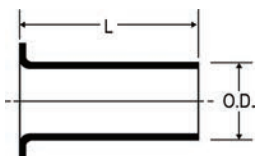

INSERTS 63PT

for industrial grade plastic tubing

Part Number	Tube OD	Tube Wall	L	OD	Std. Pkg.
63PT-0216	1/8	.016	.46	.080	100
63PT-0223		.023	.45	.073	200
63PT-0325	3/16	.025	.45	.135	100
63PT-0340		.040	.52	.095	100
63PT-0440	1/4	.040	.50	.163	200
63PT-0462		.062	.33	.110	50
63PT-0540	5/16	.040	.50	.232	100
63PT-0562		.062	.53	.187	100
63PT-0662	3/8	.062	.56	.250	200
63PT-0862	1/2	.062	.72	.370	100
63PT-1062	5/8	.062	.72	.483	100

Delrin® sleeve 60 PT and Insert 63PT convert standard compression fittings for use with industrial grades of thermoplastic tubing.

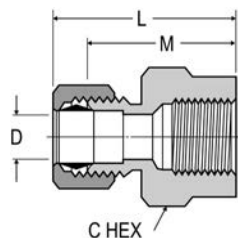

FEMALE CONNECTOR 66C
Reference SAE 060103 BA

Part Number	Tube Size	NPTF Thread	UNF Thread	Hex C	L	M	Flow Diameter	Std. Pkg.
66C-0202	1/8	1/8	5/16-24	9/16	.95	.75	.094	10
66C-0302	3/16	1/8	3/8-24	9/16	1.02	.78	.125	25
66C-0304		1/4	3/8-24	11/16	1.20	.96	.125	10
66C-0402	1/4	1/8	7/16-24	9/16	1.02	.78	.188	25
66C-0404		1/4	7/16-24	11/16	1.24	1.00	.188	10
66C-0502	5/16	1/8	1/2-24	9/16	1.07	.81	.250	10
66C-0504		1/4	1/2-24	11/16	1.29	1.03	.250	10
66C-0602	3/8	1/8	9/16-24	9/16	1.06	.78	.312	10
66C-0604		1/4	9/16-24	11/16	1.34	1.06	.312	10
66C-0606		3/8	9/16-24	13/16	1.34	1.06	.312	10
66C-0608		1/2	9/16-24	1	1.54	1.27	.312	10
66C-0804	1/2	1/4	11/16-20	11/16	1.49	1.09	.406	10
66C-0806		3/8	11/16-20	13/16	1.52	1.12	.406	10
66C-0808		1/2	11/16-20	1	1.71	1.31	.406	10
66C-1008		5/8	1/2	13/16-18	1	1.80	1.38	.500

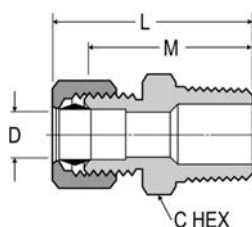

MALE CONNECTOR 68C
Reference SAE 060102 BA

Part Number	Tube Size	Pipe Thread	Straight Thread	Hex C	L	M	Flow Diameter	Std. Pkg.
68C-0202	1/8	1/8	5/16-24	7/16	.97	.77	.094	25
68C-0302	3/16	1/8	3/8-24	7/16	1.08	.84	.125	50
68C-0304		1/4	3/8-24	9/16	1.27	1.03	.125	25
68C-0402	1/4	1/8	7/16-24	7/16	1.10	.86	.188	50
68C-0404		1/4	7/16-24	9/16	1.30	1.06	.188	50
68C-0406		3/8	7/16-24	11/16	1.27	1.03	.188	10
68C-0408		1/2	7/16-24	7/8	1.55	1.31	.188	10
68C-0502	5/16	1/8	1/2-24	1/2	1.15	.89	.234	25
68C-0504		1/4	1/2-24	9/16	1.33	1.07	.250	50
68C-0602	3/8	1/8	9/16-24	9/16	1.25	.97	.250	25
68C-0604		1/4	9/16-24	9/16	1.42	1.14	.312	25
68C-0606		3/8	9/16-24	11/16	1.44	1.16	.312	25
68C-0608		1/2	9/16-24	7/8	1.53	1.25	.312	25
68C-0704	7/16	1/4	5/8-24	5/8	1.50	1.17	.312	10
68C-0804	1/2	1/4	11/16-20	11/16	1.62	1.22	.312	10
68C-0806		3/8	11/16-20	11/16	1.60	1.20	.406	25
68C-0808		1/2	11/16-20	7/8	1.71	1.31	.406	25
68C-1006	5/8	3/8	13/16-18	13/16	1.73	1.31	.406	10
68C-1008		1/2	13/16-18	7/8	1.90	1.48	.500	10
68C-1012		3/4	13/16-18	1-1/16	1.98	1.56	.500	10
68C-1208	3/4	1/2	1-18	1	2.05	1.60	.562	10
68C-1212		3/4	1-18	1-1/16	2.08	1.63	.656	10
68C-1412		7/8	3/4	1-1/8-18	1-1/8	1.76	1.41	.750

164C and 264C Series

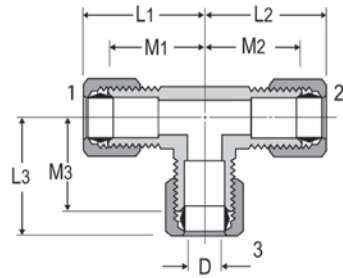

164C

UNION TEE 164C-264C

Reference SAE 060401 BA

Part Number	Tube Size 1 and 2	Tube Size 3	Straight Thread	L1	L2	L3	M1	M2	M3	Flow Diameter	Std. Pkg.
164C-02	1/8	1/8	5/16-24	.82	.82	.82	.61	.61	.61	.094	10
264C-03	3/16	3/16	3/8-24	.84	.84	.84	.60	.60	.60	.125	10
164C-04	1/4	1/4	7/16-24	.86	.86	.86	.61	.61	.61	.188	25
164C-05	5/16	5/16	1/2-24	.98	.98	.98	.71	.71	.71	.250	10
164C-06	3/8	3/8	9/16-24	1.03	1.03	1.03	.74	.74	.74	.312	25
164C-08	1/2	1/2	11/16-20	1.34	1.34	1.34	.93	.93	.93	.406	10
164C-10	5/8	5/8	13/16-18	1.54	1.54	1.54	1.08	1.08	1.08	.500	10
164C-06-06-04	3/8	1/4	---	1.03	1.03	.96	.75	.75	.72	.188	25
164C-08-08-06	1/2	3/8	---	1.34	1.34	1.16	.94	.94	.88	.312	10

165C Series

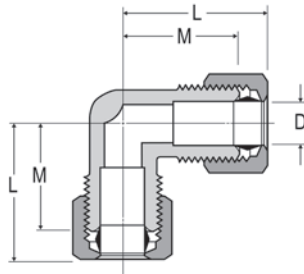

UNION ELBOW 165C

Reference SAE 060201 BA

Part Number	Tube Size	Straight Thread	L	M	Flow Diameter	Std. Pkg.
165C-02	1/8	5/16-24	.82	.61	.094	10
165C-03	3/16	3/8-24	.87	.61	.125	10
165C-04	1/4	7/16-24	.88	.61	.188	10
165C-05	5/16	1/2-24	.95	.71	.250	10
165C-06	3/8	9/16-24	1.03	.74	.312	10
165C-07	7/16	5/8-24	1.16	.82	.312	5
165C-08	1/2	11/16-20	1.34	.93	.406	10
165C-10	5/8	13/16-18	1.48	1.05	.500	10
165C-12	3/4	1-18	1.65	1.17	.560	5

169C and 269C Series

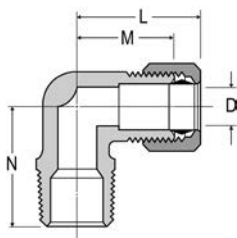

MALE ELBOW 169C-269C
Reference SAE 060202 BA

Part Number	Tube Size	Pipe Thread	Straight Thread	L	M	N	Flow Diameter D	Std. Pkg.
169C-0202	1/8	1/8	5/16-24	.80	.60	.67	.094	10
169C-0302	3/16	1/8	3/8-24	.84	.61	.69	.125	10
169C-0304		1/4	3/8-24	.86	.64	.93	.125	10
169C-0402	1/4	1/8	7/16-24	.86	.61	.74	.188	50
169C-0404		1/4	7/16-24	.86	.62	.94	.188	50
169C-0406		3/8	7/16-24	.93	.68	1.00	.188	10
169C-0502	5/16	1/8	1/2-24	.88	.61	.74	.234	10
169C-0504		1/4	1/2-24	.95	.71	.93	.250	25
169C-0506		3/8	1/2-24	1.01	.75	1.00	.250	10
169C-0602	3/8	1/8	9/16-24	1.03	.74	.74	.234	10
169C-0604		1/4	9/16-24	1.03	.74	.93	.312	25
169C-0606		3/8	9/16-24	1.03	.75	1.00	.312	25
169C-0608		1/2	9/16-24	1.22	.94	1.27	.312	10
169C-0804	1/2	1/4	11/16-20	1.34	.94	1.00	.312	10
169C-0806		3/8	11/16-20	1.34	.93	1.11	.406	10
169C-0808		1/2	11/16-20	1.48	1.06	1.15	.406	10
169C-1008		5/8	1/2	13/16-18	1.48	1.06	1.31	.500
169C-1208	3/4	1/2	1-18	1.64	1.18	1.49	.562	5
169C-1212		3/4	1-18	1.70	1.27	1.58	.562	5

170C Series

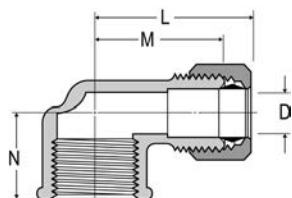

FEMALE ELBOW 170C
Reference SAE 060203 BA

Part Number	Tube Size	Pipe Thread	Straight Thread	L	M	N	Flow Diameter D	Std. Pkg.
170C-0202	1/8	1/8	5/16-24	.89	.69	.56	.094	10
170C-0302	3/16	1/8	3/8-24	.98	.73	.56	.125	25
170C-0402	1/4	1/8	7/16-24	.93	.69	.56	.188	25
170C-0404		1/4	7/16-24	1.02	.78	.70	.188	25
170C-0604	3/8	1/4	9/16-24	1.06	.79	.73	.312	10
170C-0606		3/8	9/16-24	1.22	.94	.69	.312	10
170C-0704	7/16	1/4	5/8-24	1.27	.93	.73	.312	5
170C-0806	1/2	3/8	11/16-20	1.34	1.00	.69	.406	10

171C Series

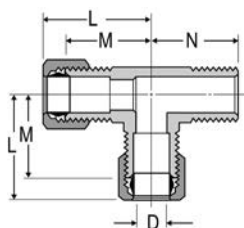

MALE RUN TEE 171C

Part Number	Tube Size	Pipe Thread	Straight Thread	L	M	N	Flow Diameter D	Std. Pkg.
171C-0202	1/8	1/8	5/16-24	.82	.61	.71	.094	10
171C-0302	3/16	1/8	3/8-24	.86	.61	.71	.125	10
171C-0402	1/4	1/8	7/16-24	.90	.64	.75	.188	10
171C-0404		1/4	7/16-24	.93	.69	.72	.188	10
171C-0604	3/8	1/4	9/16-24	1.09	.81	1.03	.312	10

172C Series

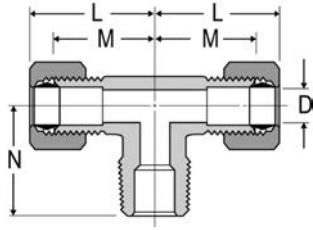

MALE BRANCH TEE 172C
Reference SAE 060425 BA

Part Number	Tube Size	Pipe Thread	Straight Thread	L	M	N	Flow Diameter D	Std. Pkg.
172C-0202	1/8	1/8	5/16-24	.82	.61	.71	.094	10
172C-0302	3/16	1/8	3/8-24	.86	.61	.71	.125	10
172C-0402	1/4	1/8	7/16-24	.86	.61	.74	.188	10
172C-0404		1/4	7/16-24	.93	.69	.92	.188	10
172C-0602	3/8	1/8	9/16-24	1.03	.75	.75	.234	10
172C-0604		1/4	9/16-24	1.09	.77	1.03	.312	10
172C-0606		3/8	9/16-24	1.09	.81	1.00	.312	10
172C-0806	1/2	3/8	11/16-20	1.34	.93	1.10	.406	10

176C Series

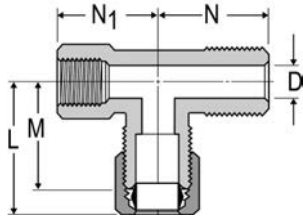

ADAPTER TEE 176C

Part Number	Tube Size	Pipe Thread	Straight Thread	L	M	N	N'	Flow Diameter D	Std. Pkg.
176C-0402	1/4	1/8	7/16-24	.93	.69	.75	.66	.189	10

177C Series

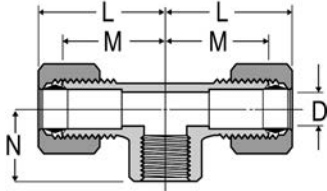

FEMALE BRANCH TEE 177C

Part Number	Tube Size	Pipe Thread	Straight Thread	L	M	N	Flow Diameter D	Std. Pkg.
177C-0402	1/4	1/8	7/16-24	.86	.63	.53	.188	10

179C Series

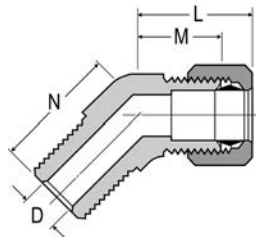

45° ELBOW 179C

Part Number	Tube Size	Pipe Thread	Straight Thread	L	M	N	Flow Diameter D	Std. Pkg.
179C-0402	1/4	1/8	7/16-24	.90	.66	.56	.188	10
179C-0404		1/4	7/16-24	.80	.56	.84	.188	10
179C-0602	3/8	1/8	9/16-24	.90	.63	.65	.234	10
179C-0604		1/4	9/16-24	.90	.63	.84	.312	10
179C-0606		3/8	9/16-24	.97	.75	.95	.312	10
179C-0806	1/2	3/8	11/16-20	1.15	.81	.95	.406	10

639C Series

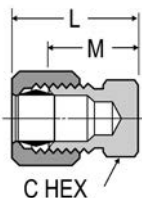

SEAL PLUG 639C

Part Number	Tube Size	Straight Thread	Hex C	L	M	Std. Pkg.
639C-04	1/4	7/16-24	7/16	.74	.50	25

682C Series

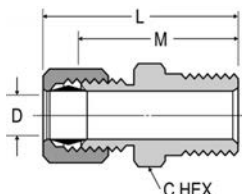

STRAIGHT THROUGH TANK FITTING 682C

Part Number	Tube Size	Pipe Thread	Straight Thread	Hex C	L	M	Flow Diameter D	Std. Pkg.
682C-0302	3/16	1/8	3/8-24	7/16	1.06	.84	.195	10
682C-0606	3/8	3/8	9/16-24	11/16	1.44	1.16	.387	10
682C-0808	1/2	1/2	11/16-20	7/8	1.90	1.31	.516	10

Specifications:

Listed with Underwriter's Laboratories for flammable liquid. Compression fittings meet functional requirements of SAE J-512, ASA and ASME.

Applications:

Use with copper, aluminum and thermoplastic tubing. Not recommended for steel tubing. Manufactured for low and medium pressure tubing connection work where excessive vibration or tube movement is not involved. Not recommended for applications using gaseous media.

Working Pressure Ranges:

Temperature and type of tubing used are important factors and the table to the right is a good guide for proper selection. Temperature **73°F**. For thermoplastic tubing see manufacturers recommendation for pressure range.

Temperature Ranges:

From **-65° to +250°F** with soft metal tubing. For thermoplastic tubing see manufacturers recommendation for tubing temperature range.

Assembly Instructions:

1. Slide nut, then sleeve onto tubing. The thread end of the nut must face out.
2. Insert the tube into the fitting. Be sure the tube is bottomed on the fitting shoulder.
3. Assemble nut to body, and tighten 'hand tight'. Then follow the number of wrench turns as indicated in the table to the right.

PSI	Tube OD (inches)	Tube Wall (inches)
400	1/8	.030
400	3/16	.030
300	1/4	.030
300	5/16	.032
200	3/8	.032
200	1/2	.032
150	5/8	.035
100	3/4	.035
75	7/8	.035

Fitting Size	Tube Size	Turns required to seal from hand tight	
		60C with soft metal tubing	60C with thermoplastic tubing
2	1/8	1-1/4	--
3	3/16	1-1/4	--
4	1/4	1-1/4	2
5	5/16	1-1/4	2
6	3/8	2-1/4	2
8	1/2	2-1/4	2
10	5/8	2-1/4	2
12	3/4	2-1/4	2
14	7/8	2-1/4	--

Features:

- Maximum working pressure: **150 PSI**
- Temperature range: **-40°F to + 200°F**



TUBING NAB

Reference SAE J844, TYPE A and B, D.O.T. FMVSS 106

Part Number	Tube Size	Standard Color	Std. Pkg.
NAB3	3/16	black	100'
NAB4	1/4	black	100'
NAB4B	1/4	blue	100'
NAB4R	1/4	red	100'
NAB6	3/8	black	100'
NAB6B	3/8	blue	100'
NAB6R	3/8	red	100'
NAB8	1/2	black	100'
NAB10	5/8	black	100'
NAB12	3/4	black	100'

TUBING CUTTER

Part Number	Description
TC97	Maximum OD 9/16"
TC97RB	Replacement blade



AIR BRAKE FITTINGS

Application:

- Designed for use in air brake systems or cab controls

Features:

- Utilize ribbed sleeve for compression and positive grip
- Machined from CA360, CA345, or CA377 brass
- Pre-applied thread sealant on all male pipe threads
- Maximum operating pressure: **150 PSI**
- Temperature range: **-40°F to 200°F**
- Compatible tubing: SAE J844 type A and B
- Specifications: meets D.O.T FMVSS 571.106 and SAE J1131, and SAE J2494

Assembly Instructions:

1. Cut tubing squarely - maximum of 15° angle allowance.
2. Check that port or mating part is clean and free of debris.
3. Insert tubing into fitting until it bottoms on seat.
4. Tighten nut with wrench until one thread remains visible on the fitting body (this will allow for a number of remakes) or, the nut should be screwed down finger tight, then wrench-tightened as indicated in the table to the right.

Tube Size	Turns required to seal from hand tight
3/16	2-1/2
1/4	3
3/8 and 1/2	4
5/8 and 3/4	3-1/2

SLEEVE 60NAB

Reference SAE 100115

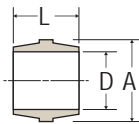

Part Number	Tube Size	A	D	L	Std. Pkg.
60NAB3	3/16	.255	.194	.23	100
60NAB4	1/4	.356	.256	.30	100
60NAB6	3/8	.479	.384	.39	100
60NAB8	1/2	.624	.509	.43	100
60NAB10	5/8	.746	.634	.49	100
60NAB12	3/4	.922	.760	.54	50

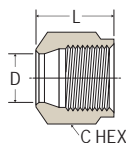

NUT 61NAB

Reference SAE 100110

Part Number	Tube Size	Straight Thread	Hex C	D	L	Std. Pkg.
61NAB3	3/16	5/16-24	7/16	.194	.40	100
61NAB4	1/4	7/16-24	9/16	.256	.45	100
61NAB6	3/8	17/32-24	5/8	.384	.63	100
61NAB8	1/2	11/16-20	13/16	.509	.72	50
61NAB10	5/8	13/16-18	15/16	.634	.77	25
61NAB12	3/4	1-18	1-1/8	.762	.81	25

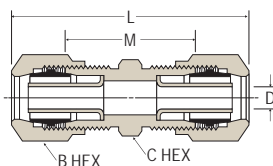

UNION 62NAB

Reference SAE 100101 BA

Part Number	Tube Size	Straight Thread	Hex B	Hex C	L	M	Flow D	Std. Pkg.
62NAB4	1/4	7/16-24	9/16	7/16	1.49	.83	.137	10
62NAB6	3/8	17/32-24	5/8	9/16	2.00	1.08	.217	10
62NAB8	1/2	11/16-20	13/16	11/16	2.33	1.29	.338	10
62NAB10	5/8	13/16-18	15/16	13/16	2.39	1.41	.398	10
62NAB12	3/4	1-18	1-1/8	1	2.60	1.58	.523	10

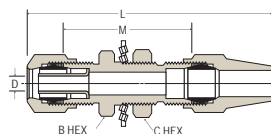

BULKHEAD UNION 62NABH

(NAB and air brake)

Part Number	Tube Size	Straight Thread	Hex B	Hex C	L	M	Flow D	Std. Pkg.
62NABH4	1/4	7/16-24	9/16	9/16	2.28	1.38	.137	10
62NABH6	3/8	17/32-24	11/16	3/4	2.97	1.62	.217	10
62NABH8	1/2	11/16-20	13/16	1	3.36	1.88	.338	10

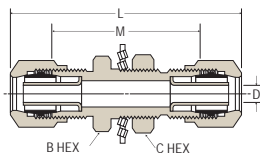

BULKHEAD UNION 62NBH

Part Number	Tube Size	Straight Thread	Hex B	Hex C	L	M	Flow D	Std. Pkg.
62NBH3	3/16	5/16-24	7/16	7/16	1.80	1.21	.087	10
62NBH4	1/4	7/16-24	9/16	9/16	2.04	1.38	.137	10
62NBH6	3/8	17/32-24	11/16	3/4	2.54	1.62	.21	10
62NBH8	1/2	11/16-20	13/16	1	2.92	1.88	.33	10
62NBH10	5/8	13/16-18	15/16	1	3.04	2.02	.398	10

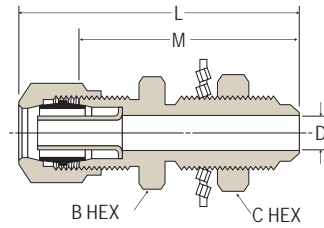

BULKHEAD UNION 62NFBH

Part Number	Tube Size	Straight Thread	Hex B	Hex C	L	M	D	Std. Pkg.
62NFBH4	1/4	7/16-24	9/16	9/16	2.04	1.38	.137	10
62NFBH6	3/8	17/32-24	11/16	3/4	2.54	1.62	.217	10
62NFBH8	1/2	11/16-20	13/16	1	2.92	1.88	.338	10
62NFBH10	5/8	13/16-18	15/16	1	3.04	2.02	.398	10

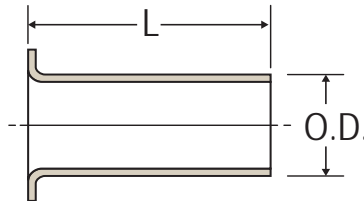

STAINLESS INSERT 63NAB
(for SAE J844 tubing)

Part Number	Tube Size	L	OD	Std. Pkg.
63NAB4	1/4	.53	.163	200
63NAB6	3/8	.64	.245	200
63NAB8	1/2	.81	.370	100
63NAB10	5/8	.86	.434	100
63NAB12	3/4	1.04	.559	100

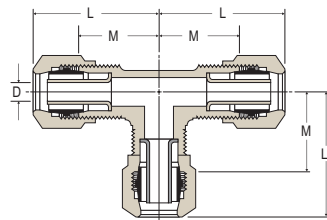

UNION TEE 64NAB
Reference SAE 100401 BA

Part Number	Tube Size	Straight Thread	L	M	Flow D	Std. Pkg.
64NAB4	1/4	7/16-24	.95	.62	.13	25
64NAB6	3/8	17/32-24	1.24	.78	.21	25
64NAB8	1/2	11/16-20	1.45	.93	.33	10
64NAB10	5/8	13/16-18	1.58	1.09	.39	10

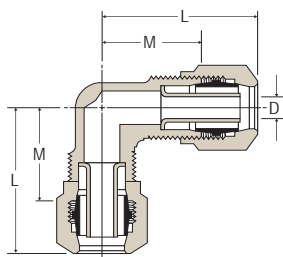

UNION ELBOW 65NAB
Reference SAE 100201 BA

Part Number	Tube Size	Straight Thread	L	M	Flow D	Std. Pkg.
65NAB4	1/4	7/16-24	.95	.62	.13	10
65NAB6	3/8	17/32-24	1.25	.79	.21	10
65NAB8	1/2	11/16-20	1.45	.93	.33	10
65NAB10	5/8	13/16-18	1.58	1.09	.39	10

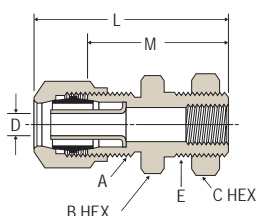

BULKHEAD UNION 66NBH

Part Number	Tube Size	Pipe Size	Straight Thread A	Straight Thread E	Hex B	Hex C	L	M	Flow D	Std. Pkg.
66NBH86	1/2	3/8	11/16-20	7/8-14	1-1/16	1-1/16	1.94	1.42	.338	10

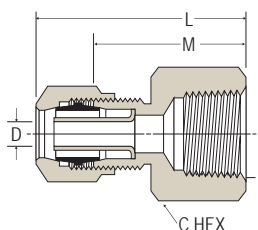

FEMALE CONNECTOR 66NAB
Reference SAE 100103 BA

Part Number	Tube Size	Pipe Thread	Straight Thread	Hex C	L	M	Flow D	Std. Pkg.
66NAB42	1/4	1/8	7/16-24	9/16	1.17	.84	.13	25
66NAB44		1/4	7/16-24	11/16	1.40	1.07	.13	10
66NAB62	3/8	1/8	17/32-24	9/16	1.46	1.00	.21	10
66NAB64		1/4	17/32-24	11/16	1.64	1.18	.21	10
66NAB86 *	1/2	3/8	11/16-20	7/8	1.79	1.27	.33	10
66NAB88		1/2	11/16-20	1-1/16	1.91	1.38	.33	10
66NAB106	5/8	3/8	13/16-18	7/8	1.87	1.38	.39	10
66NAB108		1/2	13/16-18	1-1/16	1.99	1.60	.39	10

* Not full hex as shown

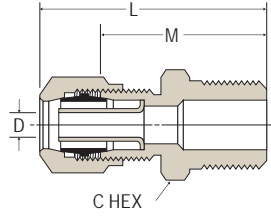

MALE CONNECTOR 68NAB

Reference SAE 100102 BA

Thread sealant may be white or burnt orange

Part Number	Tube Size	Pipe Thread	Straight Thread	Hex C	L	M	Flow D	Std. Pkg.
68NAB31VS	3/16	1/16	5/16-24	3/8	1.16	.87	.087	25
68NAB32VS		1/8	5/16-24	7/16	1.15	.86	.087	50
68NAB34VS		1/4	5/16-24	9/16	1.35	1.05	.087	25
68NAB42VS	1/4	1/8	7/16-24	7/16	1.22	.89	.13	50
68NAB44VS		1/4	7/16-24	9/16	1.43	1.09	.13	50
68NAB46VS		3/8	7/16-24	11/16	1.47	1.14	.13	10
68NAB62VS	3/8	1/8	17/32-24	9/16	1.49	1.03	.21	25
68NAB64VS		1/4	17/32-24	9/16	1.67	1.21	.21	25
68NAB66VS		3/8	17/32-24	11/16	1.70	1.21	.21	25
68NAB68VS		1/2	17/32-24	7/8	1.89	1.43	.21	25
68NAB84VS	1/2	1/4	11/16-20	11/16	1.85	1.32	.33	10
68NAB86VS		3/8	11/16-20	11/16	1.85	1.32	.33	25
68NAB88VS		1/2	11/16-20	7/8	2.04	1.52	.33	25
68NAB106VS	5/8	3/8	13/16-18	13/16	1.86	1.37	.398	10
68NAB108VS		1/2	13/16-18	7/8	2.07	1.56	.398	10
68NAB126VS	3/4	3/8	1-18	1	2.00	1.49	.440	10
68NAB128VS		1/2	1-18	1	2.19	1.68	.523	10
68NAB1212VS		3/4	1-18	1-1/16	2.22	1.71	.523	10

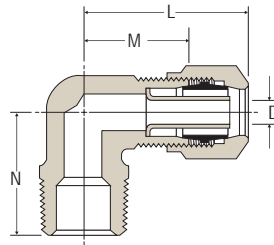

MALE ELBOW 69NAB

Reference SAE 100202 BA

Thread sealant may be white or burnt orange

Part Number	Tube Size	Pipe Thread	Straight Thread	L	M	N	Flow D	Std. Pkg.
69NAB32VS	3/16	1/8	5/16-24	.90	.60	.67	.087	10
69NAB34VS		1/4	5/16-24	.91	.62	.87	.087	10
69NAB42VS	1/4	1/8	7/16-24	.95	.62	.66	.13	50
69NAB44VS		1/4	7/16-24	1.00	.68	.87	.13	50
69NAB46VS		3/8	7/16-24	1.16	.73	.86	.13	10
69NAB62VS	3/8	1/8	17/32-24	1.19	.73	.75	.21	10
69NAB64VS		1/4	17/32-24	1.25	.79	.92	.21	25
69NAB66VS		3/8	17/32-24	1.30	.84	.91	.21	25
69NAB68VS		1/2	17/32-24	1.40	.94	1.10	.21	10
69NAB84VS	1/2	1/4	11/16-20	1.38	.86	.99	.33	10
69NAB86VS		3/8	11/16-20	1.44	.92	.99	.33	10
69NAB88VS		1/2	11/16-20	1.55	1.03	1.18	.33	10
69NAB106VS	5/8	3/8	13/16-18	1.49	1.00	1.05	.39	10
69NAB108VS		1/2	13/16-18	1.58	1.09	1.24	.39	5
69NAB128VS	3/4	1/2	1-18	1.70	1.19	1.33	.52	5
69NAB1212VS		3/4	1-18	1.77	1.26	1.32	.52	5

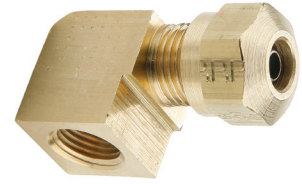
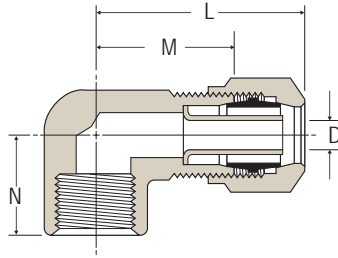

FEMALE ELBOW 70NAB
Reference SAE 100203 BA

Part Number	Tube Size	Pipe Thread	Straight Thread	L	M	N	Flow D	Std. Pkg.
70NAB32	3/16	1/8	5/16-24	.96	.67	.52	.087	10
70NAB42	1/4	1/8	7/16-24	1.02	.69	.52	.13	10
70NAB44		1/4	7/16-24	1.11	.78	.71	.13	50
70NAB62	3/8	1/8	17/32-24	1.29	.83	.59	.21	50
70NAB64 *		1/4	17/32-24	1.25	.80	.58	.21	10
70NAB66		3/8	17/32-24	1.39	.93	.77	.21	10
70NAB86	1/2	3/8	11/16-20	1.55	1.03	.82	.33	25
70NAB88		1/2	11/16-20	1.65	1.13	1.01	.33	25
70NAB108	5/8	1/2	13/16-18	1.70	1.19	1.07	.39	10

* Rounded elbow - part not as pictured

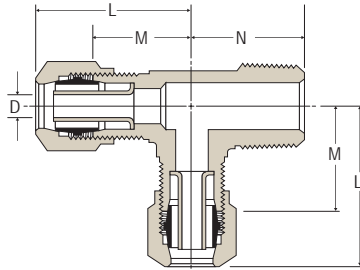

MALE RUN TEE 71NAB
Reference SAE 100424 BA

Thread sealant may be white or burnt orange

Part Number	Tube Size	Pipe Thread	Straight Thread	L	M	N	Flow D	Std. Pkg.
71NAB42VS	1/4	1/8	7/16-24	.95	.62	.66	.13	10
71NAB44VS		1/4	7/16-24	1.00	.68	.87	.13	10
71NAB64VS	3/8	1/4	17/32-24	1.25	.79	.92	.21	10
71NAB66VS		3/8	17/32-24	1.30	.84	.91	.21	10
71NAB86VS	1/2	3/8	11/16-20	1.45	.93	.99	.33	10
71NAB88VS		1/2	11/16-20	1.55	1.03	1.18	.33	10
71NAB108VS	5/8	1/2	13/16-18	1.60	1.09	1.24	.39	10

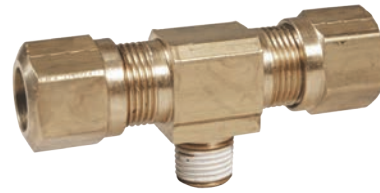
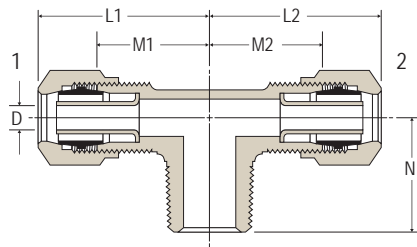

MALE BRANCH TEE 72NAB

Reference SAE 100425 BA

Thread sealant may be white or burnt orange

Part Number	Tube 1	Tube 2	Pipe Thread	Straight Thread	L ¹	L ²	M ¹	M ²	N	Flow D	Std. Pkg.
72NAB32VS	3/16	3/16	1/8	7/16-24	.90	.90	.61	.61	.66	.087	10
72NAB42VS	1/4	1/4	1/8	7/16-24	.95	.95	.62	.62	.66	.13	10
72NAB44VS		1/4	1/4	7/16-24	1.00	1.00	.68	.68	.87	.13	10
72NAB62VS	3/8	3/8	1/8	17/32-24	1.18	1.18	.72	.72	.75	.217	10
72NAB64VS		3/8	1/4	17/32-24	1.25	1.25	.81	.81	.92	.21	10
72NAB66VS		3/8	3/8	17/32-24	1.30	1.30	.84	.84	.91	.21	10
72NAB84VS	1/2	1/2	1/4	11/16-20	1.41	1.41	.89	.89	.99	.33	10
72NAB86VS		1/2	3/8	11/16-20	1.45	1.45	.93	.93	.99	.33	10
72NAB88VS		1/2	1/2	11/16-20	1.55	1.55	1.03	1.03	1.17	.33	10
72NAB108VS	5/8	5/8	1/2	13/16-18	1.60	1.60	1.09	1.09	1.24	.39	10

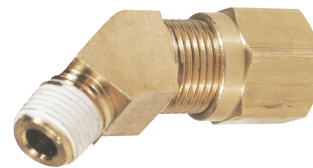
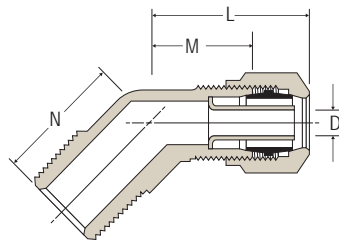

45° ELBOW 79NAB

Reference SAE 100302 BA

Thread sealant may be white or burnt orange

Part Number	Tube Size	Pipe Thread	Straight Thread	L	M	N	Flow D	Std. Pkg.
79NAB42VS	1/4	1/8	7/16-24	.81	.49	.63	.13	10
79NAB44VS		1/4	7/16-24	.93	.60	.85	.13	10
79NAB62VS	3/8	1/8	17/32-24	1.17	.71	.68	.21	10
79NAB64VS		1/4	17/32-24	1.17	.71	.85	.21	10
79NAB66VS		3/8	17/32-24	1.21	.75	.94	.21	10
79NAB68VS	1/2	1/2	17/32-24	1.24	.78	1.16	.21	10
79NAB84VS		1/4	11/16-20	1.36	.84	.94	.33	10
79NAB86VS		1/2	3/8	11/16-20	1.36	.84	.94	.33
79NAB88VS	5/8	1/2	11/16-20	1.39	.87	1.16	.33	10
79NAB106VS		3/8	13/16-18	1.43	.94	.98	.39	5
79NAB108VS		1/2	13/16-18	1.42	.93	1.16	.39	5
79NAB128VS	3/4	1/2	1-18	1.61	1.10	1.18	.51	2

AIR BRAKE FITTINGS - RUBBER HOSE

Application:

- For use with SAEJ1402 air brake hose in making hose assemblies

Compliances:

- Will meet D.O.T. FMVSS 571-106 standards when used with SAE J1402 Air Brake Hose

Material:

- Brass: Alloy 360

Performance:

- Working Pressure: up to **225 PSI**
- Temperature: **-50°F to +212°F**

Assembly Instructions:

1. Slide nut onto hose
2. Slide sleeve onto hose with tapered edge toward fitting body
3. Firmly bottom the hose into fittings
4. Screw nut onto body until it contacts the fitting's body hex

**56RBSG
Spring**

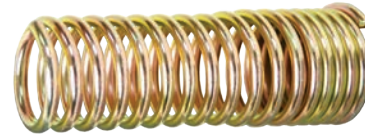
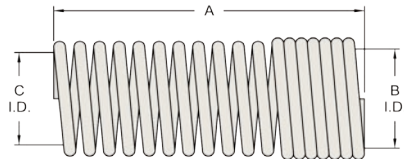

Part Number	Hose Size	A	B	C	Std. Pkg.
56RBSG-06	3/8	2.70	.87	.87	5
56RBSG-08	1/2	2.70	.96	.96	5

**60RB
Sleeve**

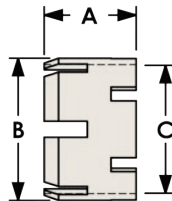

Part Number	Hose Size	A Length	B O.D.	C I.D.	Std. Pkg.
60RB-06	3/8	.64	.91	.80	10
60RB-08	1/2	.64	1.02	.92	5

**61RB
Nut**

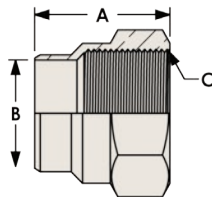

Part Number	Hose Size	C Thread	Hex	A Length	B I.D.	Std. Pkg.
61RB-06	3/8	31/32-20	1-1/32	1.13	.78	10
61RB-08	1/2	1-3/32-20	1-1/4	1.20	.92	10

**61RBSG
Spring Guard Nut**

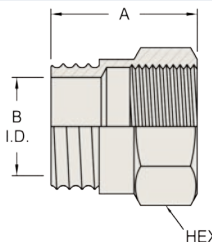

Part Number	Hose Size	Straight Thread	Hex	A	B	Std. Pkg.
61RBSG-06	3/8	31/32-20	1-1/32	1.20	.78	5
61RBSG-08	1/2	1-3/32-20	1-1/4	1.20	.92	5

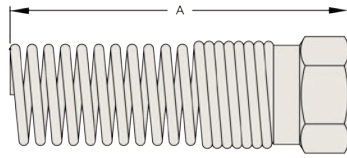

67RBSG

Air Brake Hose Nut & Attached Spring

Part Number	Length	Std. Pkg.
67RBSG-06	3.55	5
67RBSG-08	3.50	5

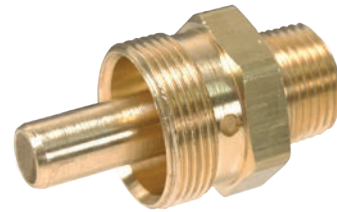
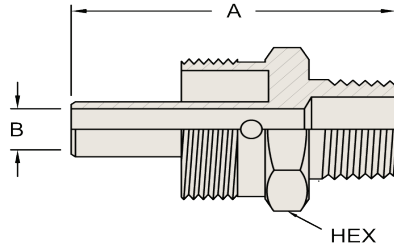

68RB

Male Connector Body Only

Part Number	Hose Size	Straight Thread	Pipe Thread	Hex	A	B	Std. Pkg.
68RB-0604B	3/8	31/32-20	1/4	31/32	1.93	.299	10
68RB-0606B		31/32-20	3/8	31/32	1.93	.299	10
68RB-0608B		31/32-20	1/2	31/32	2.12	.299	10
68RB-0806B	1/2	1-3/32-20	3/8	1-1/8	1.96	.397	5
68RB-0808B		1-3/32-20	1/2	1-1/8	2.15	.397	5

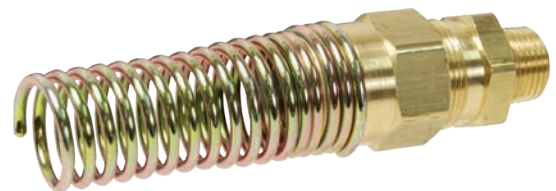
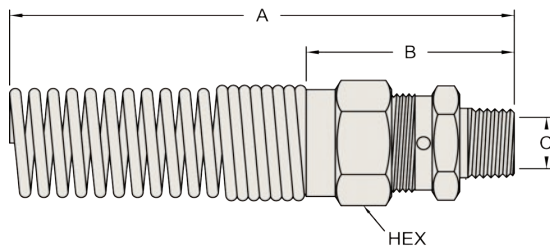

68RBSG

Male Connector With Spring Guard

Part Number	Hose Size	Pipe Thread	Hex	A	B	C	Std. Pkg.
68RBSG-0604	3/8	1/4	1-1/16	4.69	1.96	.299	2
68RBSG-0606		3/8	1-1/16	4.8	2.05	.299	2
68RBSG-0608		1/2	1-1/16	4.9	2.15	.299	2
68RBSG-0806	1/2	3/8	1-1/4	5.0	2.00	.397	2
68RBSG-0808		1/2	1-1/4	5.25	2.25	.397	2

Application:

- For use where "Lead Free" fittings are required

Conforms To:

- Safe Water Drinking Act (SWDA) of Jan. 4, 2014
- California AB1953
- RoHS Compliant

Materials:

- Lead free brass <=0.25% lead
- Alloy CA2745
- Alloy C46400

102 Series

Male Hose Barb - NPT



Part Number	Hose ID x Male NPT Thread
1020302CLF	3/16 x 1/8
1020402CLF	1/4 x 1/8
1020404CLF	1/4 x 1/4
1020502CLF	5/16 x 1/8
1020504CLF	5/16 x 1/4
1020602CLF	3/8 x 1/8
1020604CLF	3/8 x 1/4
1020606CLF	3/8 x 3/8
1020608CLF	3/8 x 1/2
1020804CLF	1/2 x 1/4
1020806CLF	1/2 x 3/8
1020808CLF	1/2 x 1/2
1021008CLF	5/8 x 1/2
1021208CLF	3/4 x 1/2
1021212CLF	3/4 x 3/4

104 Series

Female Hose Barb - Solid - NPT



Part Number	Hose ID X Female NPT Thread
1040404CLF	1/4 x 1/4
1040604CLF	3/8 x 1/4
1040606CLF	3/8 x 3/8
1040608CLF	3/8 x 1/2
1040808CLF	1/2 x 1/2

129 Series

90° Elbow - NPT



Part Number	Hose ID x Male NPT
1290404CLF	1/4 x 1/4
1290604CLF	3/8 x 1/4
1290606CLF	3/8 x 3/8

143 Series

Female Swivel Hose Barb - Dual Angle Seat



Part Number	Hose ID x Tube OD x UNF Thread
1430407KLF	1/4 x 1/4 x 7/16-20

163 Series

Solid Hex Head Plug - NPT



Part Number	NPT Thread
1630200CLF	1/8
1630400CLF	1/4

165 Series

Close Pipe Nipple - NPT

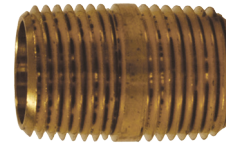

Part Number	NPT Thread x NPT Thread
1650202CLF	1/8 x 1/8
1650404CLF	1/4 x 1/4
1650606CLF	3/8 x 3/8
1650808CLF	1/2 x 1/2
1651212CLF	3/4 x 3/4

166 Series

Long Pipe Nipple - NPT



Part Number	NPT Thread x OAL
1660230CLF	1/8 x 3"
1660240CLF	1/8 x 4"
1660415CLF	1/4 x 1 1/2"
1660420CLF	1/4 x 2"
1660430CLF	1/4 x 3"
1660440CLF	1/4 x 4"
1660615CLF	3/8 x 1 1/2"
1660620CLF	3/8 x 2"
1660625CLF	3/8 x 2 1/2"
1660630CLF	3/8 x 3"
1660640CLF	3/8 x 4"
1660815CLF	1/2 x 1 1/2"

178 Series

Hose Splicer



Part Number	Hose ID x Hose ID
1780404CLF	1/4 x 1/4
1780606CLF	3/8 x 3/8
1780808CLF	1/2 x 1/2



179 Series
Hose Barb Tee Splicer

Part Number	Hose ID
1790404CLF	1/4 x 1/4 x 1/4
1790606CLF	3/8 x 3/8 x 3/8



211 Series
Square Head Plug - PTF

Part Number	PTF Thread
2110200C	1/8
2110400C	1/4
2110600C	3/8
2110800C	1/2
2111200C	3/4



213 Series
Pipe Cap - NPT

Part Number	NPT Thread
2130200CLF	1/8
2130400CLF	1/4
2130600CLF	3/8
2130800CLF	1/2
2131200CLF	3/4



219 Series
Hex Socket Plug - NPT

Part Number	NPT Thread
2190200C	1/8
2190400C	1/4
2190600C	3/8
2190800C	1/2
2191200C	3/4



272 Series
"Lok-On" Male NPT Hose Barb

Part Number	Hose ID x Male NPT Thread
2720402CLF	1/4 x 1/8
2720404CLF	1/4 x 1/4
2720604CLF	3/8 x 1/4
2720606CLF	3/8 x 3/8
2720806CLF	1/2 x 3/8
2720808CLF	1/2 x 1/2



287 Series
"Lok-On" Female Swivel Hose Barb - Dual Angle

Part Number	Hose ID x Tube OD x UNF Thread
2870407CLF	1/4x 1/4 x 7/16-20



302 Series
90° Female Pipe Elbow - NPT

Part Number	NPT Thread
3020404CLF	1/4
3020606CLF	3/8
3020808CLF	1/2
3021212CLF	3/4



304 Series
90° Street Elbow - NPT

Part Number	NPT Thread
3040202CLF	1/8 x 1/8
3040404CLF	1/4 x 1/4
3040606CLF	3/8 x 3/8
3040808CLF	1/2 x 1/2



322 Series
Female Pipe Tee - NPT

Part Number	NPT Thread
3220202CLF	1/8
3220404CLF	1/4
3220606CLF	3/8
3220808CLF	1/2
3221212CLF	3/4

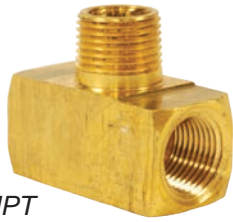

324 Series
Male Branch Tee - NPT

Part Number	NPT Thread
3240606CLF	3/8



326 Series
Street Tee - NPT

Part Number	NPT Thread
3260404CLF	1/4

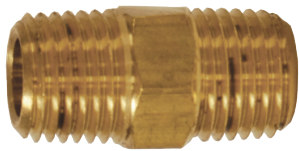

370 Series
Male Hex Nipple - NPT

Part Number	NPT Thread
3700202CLF	1/8 x 1/8
3700404CLF	1/4 x 1/4
3700606CLF	3/8 x 3/8
3700808CLF	1/2 x 1/2



371 Series
Female Hex Coupling - NPT

Part Number	Female NPT
3710202CLF	1/8 x 1/8
3710404CLF	1/4 x 1/4
3710606CLF	3/8 x 3/8
3710808CLF	1/2 x 1/2

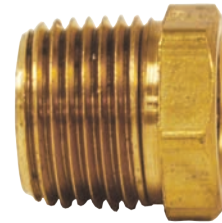

373 Series
Reducer Bushing - NPT

Part Number	Male NPT x Female NPT Thread
3730402CLF	1/4 x 1/8
3730604CLF	3/8 x 1/4
3730804CLF	1/2 x 1/4
3730806CLF	1/2 x 3/8
3731208CLF	3/4 x 1/2

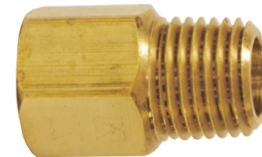

375 Series
Adapter - NPT

Part Number	Female NPT x Male NPT
3750402CLF	1/4 x 1/8
3750404CLF	1/4 x 1/4
3750604CLF	3/8 x 1/4
3750808CLF	1/2 x 1/2
3751212CLF	3/4 x 3/4



377 Series
Reducer Coupler - NPT

Part Number	Female NPT x Female NPT
3770806CLF	1/2 x 3/8
3771208CLF	3/4 x 1/2



502 Series

Female Hose x Female Pipe NPT Swivel

Part Number	GH Thread x NPT Thread
5021208CLF	$\frac{3}{4}$ x $\frac{1}{2}$
5021212CLF	$\frac{3}{4}$ x $\frac{3}{4}$



509 Series

Male Hose x Male Hose x Female Pipe

Part Number	Male GH x Male GH x Female NPT
5091212CLF	$\frac{3}{4}$ x $\frac{3}{4}$ x $\frac{1}{2}$



506 Series

Female Hose x Female Hose Swivel

Part Number	Female GH x Female GH
5061212CLF	$\frac{3}{4}$ x $\frac{3}{4}$



514 Series

Male Hose x Male Pipe x Female Pipe

Part Number	Male GH x Male NPT x Female NPT
5141212CLF	$\frac{3}{4}$ x $\frac{3}{4}$ x $\frac{1}{2}$



507 Series

Male Hose x Female Pipe Adapter

Part Number	Male GH x Female NPT
5071212CLF	$\frac{3}{4}$ x $\frac{3}{4}$



590 Series

Male Garden Hose

Part Number	Hose ID x Male GH
5900812CLF	$\frac{1}{2}$ x $\frac{3}{4}$
5901012CLF	$\frac{5}{8}$ x $\frac{3}{4}$
5901212CLF	$\frac{3}{4}$ x $\frac{3}{4}$



508 Series

Male Hose x Male Pipe Adapter

Part Number	Male GH x Male NPT
5081208CLF	$\frac{3}{4}$ x $\frac{1}{2}$



591 Series

Female Garden Hose Swivel Fitting

Part Number	Hose ID x Female GH
5910812CLF	$\frac{1}{2}$ x $\frac{3}{4}$
5911012CLF	$\frac{5}{8}$ x $\frac{3}{4}$
5911212CLF	$\frac{3}{4}$ x $\frac{3}{4}$

Lead Free

What is the new lead-free requirement?

In 2011, the Reduction of Lead in Drinking Water Act was signed into law. The Act has reduced the lead content allowed in drinking water systems and plumbing materials by changing the definition of "Lead-Free" in Section 1417 of the Safe Drinking Water Act (SDWA). The new law went into effect January 4th 2014.

Definition of "Lead-Free"

The term "lead-free" has been updated from not more than 8% lead content to mean "not more than a weighted average of 0.25% lead when used with respect to wetted surfaces of pipes, pipe fittings, plumbing fittings and fixtures."

Lead Free Exemptions

The new requirement does not apply to pipes, pipe fittings, plumbing fittings, or fixtures, including back flow preventers, that are used exclusively for non-potable services, such as manufacturing, industrial processing, irrigation, outdoor watering, or any other uses where the water is not anticipated to be used for human consumption.

Dixon Brass Standard Brass Parts

Our brass parts are machined from Brass Alloy CDA 353, 360 or 377. The lead content is 2.5% to 3.7%. Our brass shape products are produced from Alloy C3604B with a lead content of 1.8% - 3.7%. These brass alloys do not meet the low lead requirements as stated in the Safe Drinking Water Act. Dixon Brass parts are within the acceptable level for leaded brass rod for the RoHS Directive 2001/65/EU. The exemption is Annex 6(C) for copper alloy containing up to 4% lead by weight. Dixon Brass parts are also Mercury free.

The "LF" option in the catalog

We are offering select products with a "lead free" option. These will be denoted with an "LF" behind the standard part number. The "LF" option products will be functionally the same as our brass option, but the design and dimensions may be modified. All parts with the "LF" option will have $\leq 0.25\%$ lead and will meet the definition of "lead free" in Section 1417 of the Safe Water Drinking Act. Please contact Dixon if you require additional "lead free" products beyond those listed in our catalog.



Size Comparisons

Actual Outside Diameters of Pipe Threads

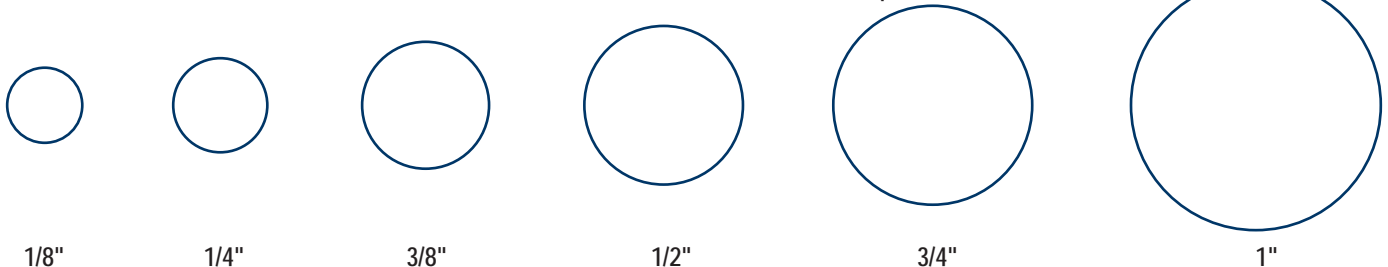

Actual Outside Diameters of Tubing

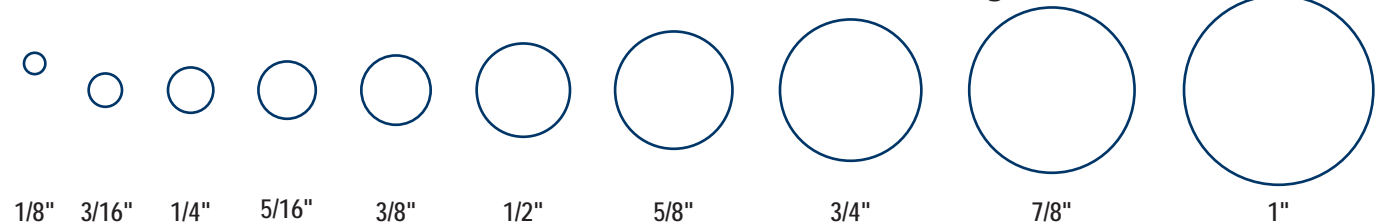

Male Thread Profiles



Threading Information

Abbreviation	System Name	Compatibility	Seal Method
BSPP	British Standard Pipe Parallel	male BSPP with female BSPP	washer
		female BSPP with male BSPP	washer
		female BSPP with male BSPT	washer
BSPT_r	British Standard Pipe Taper	male BSPT _r with female BSPT _r	thread
		male BSPT _r with female BSPP	washer
		female BSPT _r with male BSPT _r <i>female BSPT_r not compatible with male BSPP</i>	thread
CHT	American Standard Fire Hose Thread (1" National Hose Thread is Chemical Hose Thread , also known as Booster Hose Thread)	1" male NH (NST) with 1" female NH (NST)	washer
		1" female NH (NST) with 1" male NH (NST)	washer
		1" thread is used on both ¾" hose & 1" hose	not compatible
GHT	Garden Hose Thread	male GHT with female GHT	washer
		female GHT with male GHT	washer
		thread is same for all size hose	not compatible
IPS	Iron Pipe Straight Thread	generic name for Straight Pipe Thread <i>see NPSH for compatibility</i>	washer
IPT	Iron Pipe Thread	generic name for All Pipe Thread	more information required
JIC	Joint Industrial Committee	used with other mating JIC threads	mechanical
NH or NST	American Standard Fire Hose Coupling Thread (National Hose thread also known as National Standard Thread)	male NH (NST) with female NH (NST)	washer
		female NH (NST) with male NH (NST) thread pitch and diameters of fire threads may vary according to local and municipal regulations <i>not compatible with other systems</i>	washer
NPT	American Standard Taper Pipe Thread (National Pipe Tapered)	male NPT with female NPT	thread
		male NPT with female NPTF	thread
		male NPT with female NPSM	washer
		male NPT with female NPSH	washer
		female NPT with male NPT	thread
		female NPT with male NPTF <i>female NPT not compatible with male NPSM or male NPSH</i>	thread
NPTF	American Standard Taper Pipe Fuel Dryseal Thread (National Pipe Tapered Dryseal)	male NPTF with female NPTF	thread
		male NPTF with female NPT	thread
		male NPTF with female NPSM	washer
		male NPTF with female NPSH	washer
		female NPTF with male NPTF	thread
		female NPTF with male NPT	thread
		female NPTF with male NPSM or NPSH <i>NPTF with NPTF threads do not require sealant for the initial use, after that, sealant is required</i>	not compatible
NPSH	American Standard Straight Pipe for Hose Couplings (National Pipe Straight Hose)	male NPSH with female NPSH	washer
		female NPSH with male NPSH	washer
		female NPSH with male NPT	washer
		female NPSH with male NPTF	washer
		female NPSH with male NPSM	washer
NPSM	American Standard Straight Mechanical Joints (National Pipe Straight Mechanical)	male NPSM with female NPSM	Seal can be either mechanical or washer. Mating fittings must be of same type.
		male NPSM with female NPSH	
		female NPSM with male NPSM	
		female NPSM with male NPT	
		female NPSM with male NPTF	
SIPT	Straight Iron Pipe Thread	generic name for Straight Pipe Thread	washer
TIPT	Tapered Iron Pipe Thread	generic name for Tapered Pipe Thread	thread
NYC	NYC Fire Department	straight thread used in New York City	washer
Chicago	Chicago Fire Department	straight thread used in Chicago	washer

Limited Warranty

DIXON VALVE AND COUPLING COMPANY (herein called "Dixon") warrants the products described herein, and manufactured by Dixon to be free from defects in material and workmanship for a period of one (1) year from date of shipment by Dixon under normal use and service. Its sole obligation under this warranty being limited to repairing or replacing, as hereinafter provided, at its option any product found to Dixon's satisfaction to be defective upon examination by it, provided that such product shall be returned for inspection to Dixon's factory within three (3) months after discovery of the defect. The repair or replacement of defective products will be made without charge for parts or labor. This warranty shall not apply to: (a) parts or products not manufactured by Dixon, the warranty of such items being limited to the actual warranty extended to Dixon by its supplier; (b) any product that has been subject to abuse, negligence, accident, or misapplication; (c) any product altered or repaired by others than Dixon; and (d) to normal maintenance services and the replacement of service items (such as washers, gaskets and lubricants) made in connection with such services. To the extent permitted by law, this limited warranty shall extend only to the buyer and any other person reasonably expected to use or consume the goods who is injured in person by any breach of the warranty. No action may be brought against Dixon for an alleged breach of warranty unless such action is instituted within one (1) year from the date the cause of action accrues. This limited warranty shall be construed and enforced to the fullest extent allowable by applicable law.

Other than the obligation of Dixon set forth herein, Dixon disclaims all warranties, express or implied, including but not limited to any implied warranties of merchantability or fitness for a particular purpose, and any other obligation or liability. The foregoing constitutes Dixon's sole obligation with respect to damages, whether direct, incidental or consequential, resulting from the use or performance of the product.

Some products and sizes may be discontinued when stock is depleted, or may require a minimum quantity for ordering.

Limits of Liability

This catalog is intended as a product offering. It is not intended to be a user or technical manual. Information in this catalog is subject to change without notice. All users and distributors of products sold through this catalog should contact Dixon™ with questions of use, compatibilities, coupling procedures and life of product. Our full-time engineering and test staff is always available to recommend uses and to assist distributors and users with any questions.



Safety



Safety logos, which appear throughout our catalog, are used as a reminder that the user should carefully review for the appropriateness of the product for the media, application and environment in which it will be used.

NOTE: Because of the health hazards associated with contamination and lead content in drinking water systems, Dixon™ couplings, unless otherwise specifically approved, are not recommended for potable water service and should not be used in applications where drinking water will contact the wetted surfaces of the coupling.

Warning: Dixon™ products may contain chemicals known to the State of California to cause cancer, birth defects, or other reproduction harm.

Copyright

Copyright © 2016 by Dixon Valve and Coupling

All rights reserved. This book is copyrighted material. Use, reproduction or copying of it by anyone other than Dixon™ is strictly forbidden without its express written consent.

United States

Albany, NY

ph 518.725.0998
178A Corporate Drive
Gloversville, NY 12078
fx 518.725.8542

Atlanta, GA

ph 770.486.9619
101 T.D.K. Boulevard
Suite A
Peachtree City, GA 30269
fx 770.486.9813

Dallas, NC

ph 704.376.5755
2925 Chief Court
Dallas, NC 28034
fx 704.376.1557

Chestertown, MD

ph 800.355.1991
800 High Street
Chestertown, MD 21620
fx 800.283.4966

Chicago, IL

ph 630.323.3716
1011 N. Hilltop Drive
Itasca, IL 60143
fx 630.323.4120

Cleveland, OH

ph 330.425.3000
1900 Enterprise Parkway
Twinsburg, OH 44087
fx 330.425.1527

Houston, TX

ph 713.678.4291
6525 Homestead Road
Houston, TX 77028
fx 713.678.8105

Kansas City, MO

ph 816.221.0064
1244 Saline Street
N. Kansas City, MO 64116
fx 816.221.1108

Los Angeles, CA

ph 909.605.6400
8840 Flower Road
Suites150/160
Rancho Cucamonga, CA 91730
fx 909.605.6200

Portland, OR

ph 503.289.0400
2642 North Marine Drive
Portland, OR 97217
fx 503.289.0600

Salt Lake City, UT

ph 801.972.1180
McGillis Ind. Pk. Bldg., #4
1972 South 4370 West
Salt Lake City, UT 84104
fx 801.972.8063

Tampa, FL

ph 813.247.3500
5120 Adamo Drive
Suite E
Tampa, FL 33619
fx 813.247.7910

International

Edmonton, Alberta, Canada

ph 780.469.5444
fx 780.463.9205

Innisfil, Ontario, Canada

ph 705.436.1125
fx 705.436.6251

Montreal, Quebec, Canada

ph 514.422.9292
fx 514.422.0166

Wingfield SA, Australia

ph 61.8.8202.6000
fx 61.8.8202.6099

Preston, England

ph 44.1.77.232-3529
fx 44.1.77.231.4664

Troisdorf-Spich, Germany

ph 49.2241.84406.0
ph 49.2241.8440679

Monterrey, Mexico

ph 52.81.8354.5649
fx 52.81.8354.8197



The Right Connection®

Dixon Brass

40 Chestnut Avenue
Westmont, IL 60559-1128
ph 800.323.4440 local 630.323.4442
fx 800.628.7259 local 630.323.4317
brasssales@dixonvalve.com

dixonvalve.com



customer service

