



Care, Use & Inspection	32
Herc-Alloy 800 Chain	33
Herc-Alloy 800 Slings	34-35
Herc-Alloy 800 Components	36-37
Master Link	38
Forged Master Link	38
Master Link with Flats	39
Flat Bottom Master Link	39
Sub-Assembly	40
Sub-Assembly with Flats	40
Master Ring	41
Grab Link	41
Omegalok Connector	42
Hammerlok	42
Clevlok Sling Hook	43
Eye Sling Hook	43
Clevlok Grab Hook	44
Clevlok Cradle Grab Hook	44
Eye Cradle Grab Hook	45
Eye Foundry Hook	45
Sorting Hook	46
Sorting Hook with Handle	46
Plate Hook	47
“S” Hook	47
Specialty Hooks	48
Stainless Steel Chain	49
Stainless Steel Master Link	50

The life and strength of Herc-Alloy 800 chain slings depend on proper inspection, maintenance and use. For additional information, refer to ASME B30.9 and OSHA 1910.184.

Care

- Chain requires careful storage and regular maintenance.
- Store chains on an A frame in a clean, dry place.
 - To avoid corrosion, oil chains before prolonged storage.
 - Do not heat Herc-Alloy 800 chain; this will alter its thermal treatment.

Use

To protect both operators and materials, observe these precautions when using chain slings:

- Before use, inspect chain and attachments following the instructions under "Inspection" below.
- Do not exceed working load limit. Any of the factors listed here can reduce the load the chain will hold:
 - Acceleration in rate of load application can produce dangerous overloads.
 - Variations in the angle of the load to the sling, will change the WLL please refer to the chart on page 36 for proper WLL.
 - Twisting, knotting or kinking, subjects links to unusual loading, decreasing the working load of the sling.
 - Use for purposes other than those for which slings are intended, can reduce the working load of the sling.
- Free chain of all twists, knots and kinks.
- Center load in hook(s); hook latch must not support load.
- Avoid sudden jerks when lifting or lowering load.
- Balance all loads; avoid tipping of loads.
- Use pads around sharp corners.
- Do not drop load on chains.
- Match the size and working load limits of attachments such as hooks and rings to the size and working load limits of the chain.
- For overhead lifting, use only alloy chain and attachments.

Inspection

It is important both to inspect chain slings regularly and to keep a record of all chain inspections. Follow this guide for such an inspection system.

- Before inspecting, clean chain with a non-acid/non-caustic solvent so that marks, nicks, wear and other defects are visible.
- Inspect each link for these conditions:
 - Twists and bends.
 - Nicks or gouges.
 - Excessive wear at bearing points.
- Stretch.
- Distorted or damaged master links, coupling links or attachments, especially spread in throat opening of hooks.
- Mark plainly with paint each link or attachment showing any of the conditions listed here to indicate rejection; remove from service until properly repaired.

Wear Allowances of Herc-Alloy 800 Chain

Measure cross section at link ends to determine wear. If chain is worn to less than the minimum allowable thickness, remove from service.

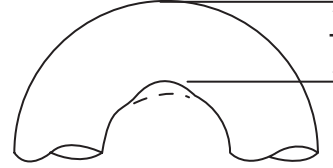

Chain Size		Minimum Allowable Thickness (T)	
in.	mm	in.	mm
7/32	5.5	0.189	4.8
9/32	7.0	0.239	6.1
3/8	10.0	0.342	8.7
1/2	13.0	0.443	11.3
5/8	16.0	0.546	13.9
3/4	20.0	0.687	17.5

CM Chain Inspection Programs

CM provides chain users with a wide range of informative materials and instructive programs on chain and chain inspection. Our colorful chain safety poster/chart and our fact-filled booklet, "CM Lifting, Pulling & Binding Products Manual PMC-10," are available on request.

Use of Chain & Components Under Extreme Temperature Conditions

When the chain itself is subjected to temperatures shown here, working load limits should be reduced as indicated.

Temperature		Reduction of Working Load Limit	
		While at Temperature	After Exposure to Temperature
°F	°C		
Below 400	Below 204	None	None
400	204	10%	None
500	260	15%	None
600	316	20%	5%
700	371	30%	10%
800	427	40%	15%
900	482	50%	20%
1000	538	60%	25%

The identification tag found on each chain sling contains this information:

- Grade • Size • Reach • Serial Number • Number of Legs
- Working Load Limit (at a specific angle of lift)

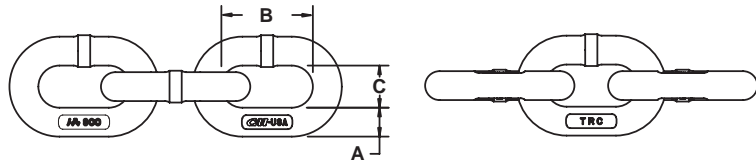

Chain Size	Working Load Limit	Chain Product Code	Nominal Chain Dimensions			Chain Weight	Approx No. Of Links	Drum Data		
			Material Diameter A	Inside Length B	Inside Width C			Drum Product Code	Length	Drum Weight
Imperial Units										
in.	lb.		in.	in.	in.	lb./ft.	per ft.		ft.	lb.
7/32	2,100	607020	0.218	0.676	0.312	0.44	17.8	677010	800	354
9/32	3,500	607028	0.281	0.883	0.395	0.73	13.6	677011	500	365
5/16	4,500	607031	0.315	1.019	0.455	0.91	11.8	NA	NA	NA
3/8	7,100	607037	0.394	1.247	0.574	1.44	9.6	677013	500	719
1/2	12,000	607050	0.512	1.440	0.734	2.55	8.3	677015	300	765
5/8	18,100	607062	0.630	1.777	0.855	3.82	6.8	677016	200	765
3/4	28,300	607075	0.787	2.234	1.070	5.95	5.4	677017	100	596
7/8	34,200	607087	0.875	2.250	1.137	7.76	5.3	677018	100	776
1	47,700	607101	1.000	3.070	1.490	9.39	3.9	677019	100	939
1-1/4	72,300	607128	1.250	3.920	1.740	14.20	3.06	677070	90	1,278

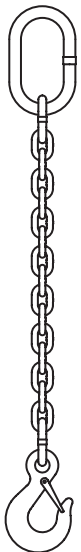

How to Select and Order the Proper Chain Sling

1. Determine the weight and configuration of the load(s) to be lifted.
2. Determine the type of chain sling required, according to weight and configuration.
3. Determine the size of the chain according to the working load limits. Be sure to take into consideration the effect of the required angle. The working load limit is the maximum load in pounds which should ever be applied in direct tension to a straight length of chain.
4. Determine the reach required to give the desired angle. The reach is measured from the upper bearing surface of the master link to the bearing surface of the lower attachment. If chain slings are to be used in pairs and are to be matched for reach, please indicate when ordering.

HERC-ALLOY® Slings

800

Types of Chain Slings

In describing the type, the following symbols should be used if attachments are other than standard, give detail specifications.

First symbol (basic type)

- S** Single chain sling
- C** Single choker chain sling with a standard end link on each end, no hook
- D** Double branch chain sling (2 legs)
- T** Triple branch chain sling (3 legs)
- Q** Quad branch chain sling (4 legs)

Second symbol (type of master link or end link)





- O** Oblong master link of standard dimensions

Third symbol (type of hook)

- S** Sling hook
- G** Grab hook
- F** Foundry hook
- L** Lodelok hook

Additional coding is defined as follows

- AS** Adjustable single
- ES** Endless single
- SAL** Single adjustable loop
- AD** Adjustable double
- SB** Single basket
- ED** Endless double
- DAL** Double adjustable loop
- DB** Double basket

	Single (1 Leg)	Double (2 Legs)			Triple (3 Legs)			Quad (4 Legs)		
										
Chain Size	Working Load Limit for Angles Available (shown below)									
	90°	60°	45°	30°	60°	45°	30°	60°	45°	30°
Imperial										
in.	lb.									
7/32	2,100	3,600	3,000	2,100	5,500	4,400	3,200	5,500	4,400	3,200
9/32	3,500	6,100	4,900	3,500	9,100	7,400	5,200	9,100	7,400	5,200
5/16	4,500	7,800	6,400	4,500	11,700	9,500	6,800	11,700	9,500	6,800
3/8	7,100	12,300	10,000	7,100	18,400	15,100	10,600	18,400	15,100	10,600
1/2	12,000	20,800	17,000	12,000	31,200	25,500	18,000	31,200	25,500	18,000
5/8	18,100	31,300	25,600	18,100	47,000	38,400	27,100	47,000	38,400	27,100
3/4	28,300	49,000	40,000	28,300	73,500	60,000	42,400	73,500	60,000	42,400
7/8	34,200	59,200	48,400	34,200	88,900	72,500	51,300	88,900	72,500	51,300
1	47,700	82,600	67,400	47,700	123,900	101,200	71,500	123,900	101,200	71,500
1-1/4	72,300	125,200	102,200	72,300	187,800	153,400	108,400	187,800	153,400	108,400

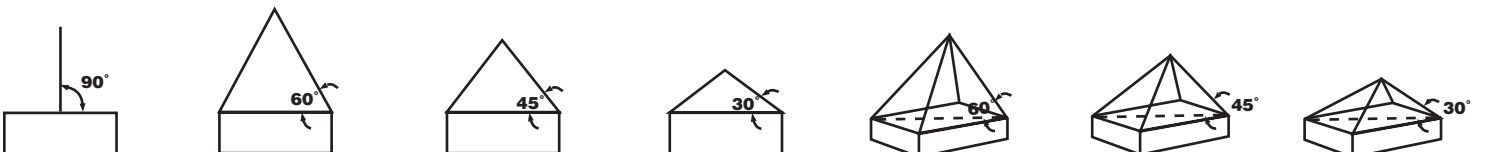

Any Sling to fit your application



Magnet Sling







Bail Sling



Adjust-A-Link



Adjustable Chain Sling











SLING CONFIGURATION	Single Basket	Double Basket	Single Endless	Double Endless
				
Chain Size	Working Load Limits			
	60°	60°	60°	60°
Imperial				
in.	lb.			
7/32	3,600	5,500	2,100	3,600
9/32	6,100	9,100	3,500	6,100
5/16	7,800	11,700	4,500	7,800
3/8	12,300	18,400	7,100	12,300
1/2	20,800	31,200	12,000	20,800
5/8	31,300	47,000	18,100	31,300
3/4	49,000	73,500	28,300	49,000
7/8	59,200	88,900	34,200	59,200
1	82,600	123,900	47,700	82,600
1-1/4	125,200	187,800	72,300	125,200

HERC-ALLOY® Components

800

Columbus McKinnon is a leader in quality and manufacturing excellence. With over 130 years of material handling experience, we strive for superior customer service in all aspects of our business. Columbus McKinnon pioneered the welding of Herc-Alloy over 70 years ago, and we continue to upgrade our process with the latest in technology and mechanical equipment. We are the original designer of the mechanical coupler link, trademark Hammerlok, as well as the Clevlok style hook for overhead lifting slings. From beam to hoist to below the hook attachments, the product offering that represents CM Complete Lifting Systems is unparalleled in the industry. Additionally, diverse training programs in the areas of rigging, applications, safety, and service are components of the package available to users and distributors when they purchase CM products.

Chain and forge divisions are ISO certified companies, and a direct, highly trained, sales force provides expertise in numerous areas. All rigging products from chain to master links to forged attachments are produced in Columbus McKinnon facilities, thus ensuring form and fit.

	COMPONENTS									
	Chain Size	Working Load Limit	Chain (Bulk)	Chain (Drum)	Master Link	Forged Master Link	Master Link w/ Flats	Sub-Assembly	Sub-Assembly w/ Flats	Omega Links
	in.				Page 38	Page 38	Page 39	Page 40	Page 40	Page 42
SINGLE										
	7/32	2,100	607020	677010	554931	-	ML040	-	-	-
	9/32	3,500	607028	677011	554932	-	ML040	-	-	644128
	3/8	7,100	607037	677013	554935	-	ML063	-	-	644138
	1/2	12,000	607050	677015	554938	M50P	ML075	-	-	644150
	5/8	18,100	607062	677016	554938	M62P	ML100	-	-	644162
	3/4	28,300	607075	677017	554940	M75P	ML125	-	-	-
	7/8	34,200	607087	677018	554943	-	ML125	-	-	-
	1	47,700	607101	677019	554946	M100P	ML150	-	-	-
1-1/4	72,300	607128	677070	554949	-	ML200	-	-	-	
DOUBLE	7/32	3,600	607020	677010	554931	-	ML050	-	-	-
	9/32	6,100	607028	677011	554932	-	ML063	-	-	644128
	3/8	12,300	607037	677013	554935	-	ML075	-	-	644138
	1/2	20,800	607050	677015	554938	M50P	ML100	-	-	644150
	5/8	31,300	607062	677016	554940	M62P	ML125	-	-	644162
	3/4	49,000	607075	677017	554943	M75P	ML150	-	-	-
	7/8	59,200	607087	677018	554946	-	ML175	-	-	-
	1	82,600	607101	677019	554949	M100P	ML200	-	-	-
	1-1/4	125,200	607128	677070	554951	-	ML250	-	-	-
TRIPLE & QUAD	7/32	5,500	607020	677010	-	-	-	554974	SA063	-
	9/32	9,100	607028	677011	-	-	-	554975	SA075	644128
	3/8	18,400	607037	677013	-	-	-	554976	SA100	644138
	1/2	31,200	607050	677015	-	-	-	554977	SA125	644150
	5/8	47,000	607062	677016	-	-	-	554978	SA175	644162
	3/4	73,500	607075	677017	-	-	-	554979	SA200	-
	7/8	88,900	607087	677018	-	-	-	554980	SA225	-
	1	123,900	607101	677019	-	-	-	554981	SA250	-
	1-1/4	187,800	607128	677070	-	-	-	554983	SA300	-



Overhead Lifting

	COMPONENTS									
	Chain Size	Hammerlok	Clevlok Sling Hook w/ Latch	Clevlok Sling Hook w/o Latch	Eye Sling Hook w/ Latch	Eye Sling Hook w/o Latch	Clevlok Grab Hook	Clevlok Cradle Grab Hook	Eye Cradle Grab Hook	Foundry Hook (Eye)
	in.	Page 42	Page 43	Page 43	Page 43	Page 43	Page 44	Page 44	Page 45	Page 45
SINGLE	7/32	-	-	-	558544	458544	-	-	559318	-
	9/32	664028-2	657318	557318	558322	458722	659232	659222	559325	474498
	3/8	664038-2	657319	557319	558325	458725	659235	659225	559337	474499
	1/2	664050-2	657320	557320	558328	458728	659238	659228	559350	474500
	5/8	664062-2	657321	557321	558329	458729	659239	659229	559362	474501
	3/4	664075-2	657322	553322	558330	458730	-	659430	559575	474502
	7/8	664089-2	-	-	558332	458732	-	-	559387	474503
	1	664100-2	-	-	558333	458733	-	-	559100	474504
	1-1/4	664125-2	-	-	558335	458735	-	-	559124	474505
DOUBLE	7/32	-	-	-	558544	458544	-	-	559318	-
	9/32	664028-2	657318	557318	558322	458722	659232	659222	559325	474498
	3/8	664038-2	657319	557319	558325	458725	659235	659225	559337	474499
	1/2	664050-2	657320	557320	558328	458728	659238	659228	559350	474500
	5/8	664062-2	657321	557321	558329	458729	659239	659229	559362	474501
	3/4	664075-2	657322	553322	558330	458730	-	659430	559575	474502
	7/8	664089-2	-	-	558332	458732	-	-	559387	474503
	1	664100-2	-	-	558333	458733	-	-	559100	474504
	1-1/4	664125-2	-	-	558335	458735	-	-	559124	474505
TRIPLE & QUAD	7/32	-	-	-	558544	458544	-	-	559318	-
	9/32	664028-2	657318	557318	558322	458722	659232	659222	559325	474498
	3/8	664038-2	657319	557319	558325	458725	659235	659225	559337	474499
	1/2	664050-2	657320	557320	558328	458728	659238	659228	559350	474500
	5/8	664062-2	657321	557321	558329	458729	659239	659229	559362	474501
	3/4	664075-2	657322	553322	558330	458730	-	659430	559575	474502
	7/8	664089-2	-	-	558332	458732	-	-	559387	474503
	1	664100-2	-	-	558333	458733	-	-	559100	474504
	1-1/4	664125-2	-	-	558335	458735	-	-	559124	474505

HERC-ALLOY® Master Links

800

Master Link



- Designed to accept HA 800 chain and components
- Durable orange powder coat finish
- May be used for mechanical and welded sling assemblies
- 100% proof tested

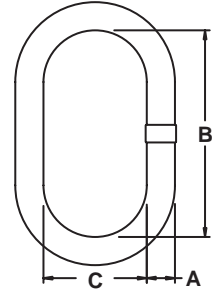

Trade Size	Working Load Limit	Catalog No.	Product Code	Nominal Dimensions			Weight	Type and size of Chain Sling	
				Material Diameter A	Inside Length B	Inside Width C		Single	Double
Imperial									
in.	lb.			in.	in.	in.	lb.	in.	in.
3/8	3,600	HA40	554931	0.406	3.00	1.500	0.33	7/32	7/32
1/2	6,100	HA50	554932	0.512	5.00	2.500	0.81	9/32	9/32
3/4	12,300	HA75	554935	0.750	5.50	2.750	2.08	3/8	3/8
1	20,800	HA100	554938	1.000	7.00	3.500	4.59	1/2 or 5/8	1/2
1-1/4	31,300	HA125	554940	1.250	8.75	4.375	9.31	3/4	5/8
1-1/2	49,000	HA150	554943	1.500	10.50	5.250	15.66	7/8	3/4
1-3/4	73,500	HA175	554946	1.750	12.00	6.000	24.44	1	7/8
2	88,900	HA200	554949	2.000	14.00	7.000	37.27	1-1/4	1
2-1/4	125,200	HA225	554951	2.250	16.00	8.000	54.03	–	1-1/4
2-3/4	187,800	HA275	554957	2.750	16.00	9.000	84.84	–	–

Forged Master Link



- Quench and tempered alloy steel
- 100% proof tested
- Raised markings for better identification
- Orange paint
- Fatigue rated to Grade 80 specifications

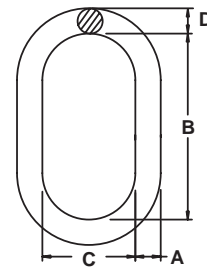

Trade Size	Working Load Limit	Product Code	Nominal Dimensions				Weight
			Material Diameter A	Inside Length B	Inside Width C	End D	
Imperial							
in.	lb.		in.	in.	in.	in.	lb.
1/2	5,100	M50P	0.500	5.00	2.50	5.360	0.90
5/8	7,700	M62P	0.625	6.00	3.00	6.880	1.75
3/4	10,600	M75P	0.750	6.00	3.00	8.120	2.35
1	20,400	M100P	1.000	8.00	4.00	1.125	6.00



Master Link with Flats

- Designed to accept HA 800 Chain, Wire Rope and Synthetic
- Use with mechanical and welded assemblies
- Sizes up to 1 1/4" available with flats to accommodate Omega link
- 100% proof tested
- Extra wide body for Wire Rope applications

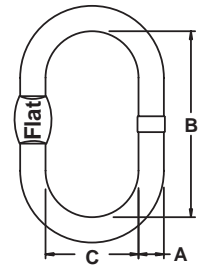

Trade Size	Working Load Limit	Product Code	Nominal Dim.			Weight	Type & Size of Chain Sling	
			Material Diameter A	Inside Length B	Inside Width C		Single	Double
Imperial								
in.	lb.		in.	in.	in.	lb.	in.	in.
7/16	4,200	ML040	0.437	4.130	2.294	0.50	7/32 & 9/32	–
1/2	5,750	ML050	0.512	4.838	2.688	0.80	–	7/32
5/8	9,000	ML063	0.625	5.292	2.977	1.34	3/8	9/32
3/4	14,200	ML075	0.750	6.611	3.719	2.36	1/2	3/8
7/8	17,300	ML087	0.875	7.350	4.135	3.60	–	–
1	26,500	ML100	1.000	7.526	4.301	5.20	5/8	1/2
1-1/4	37,400	ML125	1.250	9.261	5.292	9.60	3/4 & 7/8	5/8
1-1/2	53,000	ML150	1.500	11.025	6.300	16.20	1	3/4
1-3/4	72,150	ML175	1.750	12.863	7.350	25.10	–	7/8
2	94,200	ML200	2.000	14.700	8.400	38.40	1-1/4	1
2-1/4	119,200	ML225	2.250	16.538	9.450	54.60	–	–
2-1/2	147,150	ML250	2.500	18.375	10.500	74.90	–	1-1/4
2-3/4	178,050	ML275	2.750	20.213	11.550	99.80	–	–
3	240,850	ML300	3.000	18.900	11.025	114.00	–	–
3-1/4	282,650	ML325	3.250	20.475	11.944	145.00	–	–
3-1/2	327,800	ML350	3.500	22.050	12.863	181.13	–	–

Flat Bottom Master Link



- Designed to accept HA 800 chain and components
- Made from Alloy Steel
- Extra wide width allows for larger hook usage
- 100% proof tested

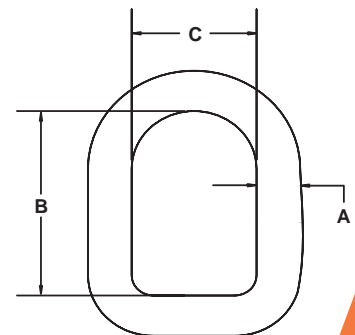

Chain Size	Trade Size	Working Load Limit	Product Code	Material Diameter A	Inside Length B	Inside Width C	Weight
Imperial							
in.	in.	lb.		in.	in.	in.	lb.
5/8 & 3/4	1-3/4	73,500	554966	1.750	8.000	5.000	18.96
7/8 & 1	2	123,900	554950	2.000	8.980	5.000	28.04
1 & 1/4	2-1/2	187,800	554965	2.500	11.920	6.500	54.73

HERC-ALLOY® Sub-Assemblies

800

Sub-Assembly



- Designed for triple and quad branch HA 800 slings
- Consists of an Oblong Master link and two Master Coupling links
- Durable orange powder coat finish
- May be used for mechanical and welded sling assemblies
- 100% proof tested

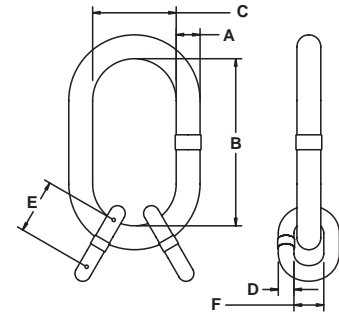

Trade Size	Catalog No.	Working Load Limit at 60°	Product Code	Master Link Nominal Dim.			Intermediate Link Nominal Dim.			Weight	Type & Size of Chain Sling on Which Used	
				Material Diameter A	Inside Length B	Inside Width C	Material Diameter D	Inside Length E	Inside Width F		Triple	Quad
Imperial												
in.		lb.		in.	in.	in.	in.	in.	in.	lb.	in.	in.
1/2	HA50-SA	7,000	554974	0.512	5.000	2.500	0.343	1.125	0.625	0.79	7/32	7/32
3/4	HA75-SA	14,200	554975	0.750	5.500	2.750	0.512	1.750	1.063	2.08	9/32	9/32
1	HA100-SA	24,000	554976	1.000	7.000	3.500	0.656	2.250	1.250	4.59	3/8	3/8
1-1/4	HA125-SA	36,200	554977	1.250	8.750	4.375	0.906	3.125	1.750	9.16	1/2	1/2
1-1/2	HA150-SA	56,600	554978	1.500	10.500	5.250	1.125	4.000	2.250	15.66	5/8	5/8
1-3/4	HA175-SA	84,900	554979	1.750	12.000	6.000	1.250	4.380	2.375	24.44	3/4	3/4
2	HA200-SA	102,600	554980	2.000	14.000	7.000	1.500	5.250	2.750	37.27	7/8	7/8
2-1/4	HA225-SA	144,600	554981	2.250	16.000	8.000	1.750	6.000	3.000	54.03	1	1
2-3/4	HA275-SA	216,900	554983	2.750	16.000	9.000	2.000	7.000	3.500	84.84	1-1/4	1-1/4



Sub-Assembly with Flats

- Designed to accept Herc-Alloy 800 chain, wire rope and synthetic
- Durable orange powder finish
- 100% proof tested
- May be used for mechanical and welded sling assemblies
- Extra wide body for wire rope applications
- Sizes up to 1 1/4" intermediate links available with flats to accommodate Omega link

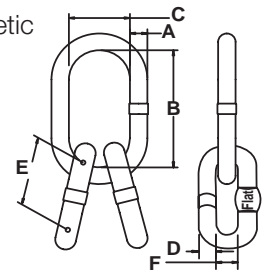

Trade Size	Working Load Limit	Product Code	Master Link Nominal Dim.			Intermediate Link Nominal Dim.			Weight	Type & Size of Chain Sling on which used	
			Material Diameter A	Inside Length B	Inside Width C	Material Diameter D	Inside Length E	Inside Width F		Triple	Quad
Imperial											
in.	lb.		in.	in.	in.	in.	in.	in.	lb.	in.	in.
1/2	4,600	SA050	0.512	4.838	2.688	0.437	4.130	2.294	1.8	-	-
5/8	7,200	SA063	0.625	5.292	2.977	0.512	4.838	2.688	2.9	7/32	7/32
3/4	11,200	SA075	0.750	6.611	3.719	0.625	5.292	2.977	5.0	9/32	9/32
7/8	13,840	SA087	0.875	7.350	4.135	0.625	5.292	2.977	6.3	-	-
1	21,200	SA100	1.000	7.526	4.301	0.750	6.611	3.719	9.9	3/8	3/8
1-1/4	29,920	SA125	1.250	9.261	5.292	1.000	7.526	4.301	19.9	1/2	1/2
1-1/2	42,400	SA150	1.500	11.025	6.300	1.000	7.526	4.301	26.5	-	-
1-3/4	57,720	SA175	1.750	12.863	7.350	1.250	9.261	5.292	44.0	5/8	5/8
2	75,360	SA200	2.000	14.700	8.400	1.500	11.025	6.300	70.8	3/4	3/4
2-1/4	95,360	SA225	2.250	16.538	9.450	1.750	12.863	7.350	104.8	7/8	7/8
2-1/2	117,720	SA250	2.500	18.375	10.500	1.750	12.863	7.350	125.2	1	1
2-3/4	142,400	SA275	2.750	20.213	11.550	2.000	14.700	8.400	176.5	-	-
3	192,680	SA300	3.000	18.900	11.025	2.250	16.538	9.450	223.2	1-1/4	1-1/4
3-1/4	226,120	SA325	3.250	20.475	11.944	2.500	18.375	10.500	294.9	-	-
3-1/2	262,240	SA350	3.500	22.050	12.863	2.750	20.213	11.550	380.6	-	-

Master Ring



- Made from alloy material
- Proof tested at two times WLL
- Durable orange powder finish

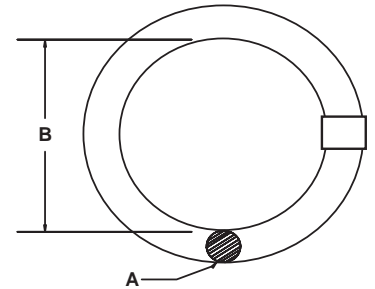

Trade Size	Working Load Limit	Finished Code	Dimensions		Weight	Type and Size of Chain Sling			
			Material Diameter A	Inside Length B		Single	Double	Triple	Quad.
Imperial									
in.	lb.		in.	in.	lb.	in.	in.	in.	in.
1/2	3,500	554611	0.512	2.500	0.52	7/32 & 9/32	—	—	—
5/8	6,100	554613	0.625	3.000	0.99	—	7/32	7/32	7/32
3/4	10,500	554615	0.750	4.000	1.86	3/8	9/32	9/32	9/32
7/8	12,300	554617	0.875	4.000	2.60	1/2	—	—	—
1	18,400	554619	1.000	4.000	3.45	5/8	3/8	—	—
1-1/4	28,300	554623	1.250	5.000	6.98	3/4	1/2	3/8	3/8
1-1/2	31,300	554627	1.500	6.000	11.80	—	—	—	—
1-3/4	53,000	554630	1.750	7.000	18.70	7/8 & 1	5/8	1/2	1/2
2	73,500	554635	2.000	8.000	27.90	1-1/4	7/8	5/8	5/8
2-1/4	88,900	554636	2.250	9.000	39.90	—	—	3/4	3/4
2-1/2	141,000	554640	2.500	10.000	54.60	—	1	7/8 & 1	7/8 & 1

Grab Link



- Made from alloy material
- Proof tested at two times the WLL
- Economical chain adjuster for single slings

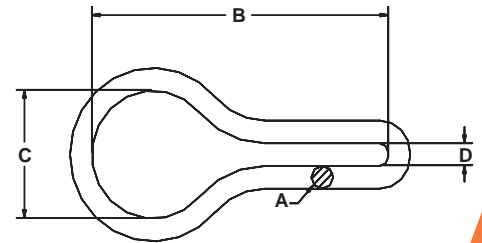

Trade Size	Working Load Limit	Product Code	Diameter A	Inside Length B	Inside Width C	Inside Width D	Weight
Imperial							
in.	lb.		in.	in.	in.	in.	lb.
1/2	3,500	554320	0.512	5.500	2.500	0.580	0.81
3/4	7,100	554326	0.750	6.063	2.750	0.625	2.08
1	12,000	554332	1.000	7.625	3.500	0.750	4.59
1-1/4	18,100	554337	1.250	9.250	4.375	1.000	9.16
1-3/8	28,300	554342	1.375	11.250	6.000	1.125	14.28
1-1/2	34,200	554347	1.500	11.750	5.250	1.375	16.75
1-3/4	47,700	554352	1.750	13.750	7.000	1.500	26.69

HERC-ALLOY® Connector Links

800

Omegalok Connector



- Fraction and metric markings
- Painted orange for easy Grade 80 identification
- 100% proof tested
- Fatigue rated to Grade 80 specifications
- For use with master link w/flats

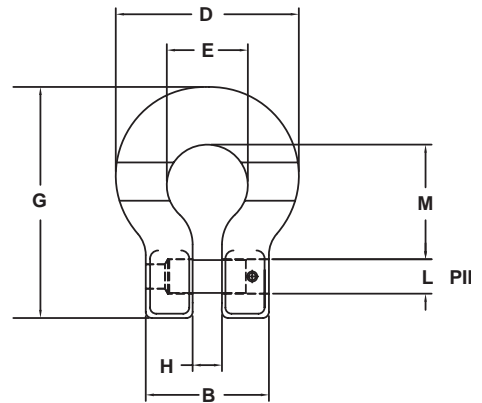

Size	Working Load Limit	Product Code	Load Pin	Retainer Pin	Dimensions								Weight
					B	D	E	G	H	L	M	T	
Imperial													
in.	lb.				in.	in.	in.	in.	in.	in.	in.	in.	lb.
9/32	3,500	644128	595780	602326	1.36	2.30	0.98	2.81	0.33	0.36	1.45	0.43	0.40
3/8	7,100	644138	595781	495821	1.90	2.82	1.25	3.57	0.45	0.51	1.77	0.57	1.02
1/2	12,000	644150	595782	495822	2.31	3.52	1.56	4.44	0.59	0.63	2.26	0.70	1.92
5/8	18,100	644162	595785	495823	2.87	4.46	2.00	5.45	0.75	0.78	2.72	0.88	3.20

Hammerlok



- Attaches chain to master link and hooks
- Quench and tempered alloy steel
- 100% proof tested
- Fatigue rated
- Replacement kits available
- Split ring retainer pin available
- 7/32 available in splitting and patlok styles

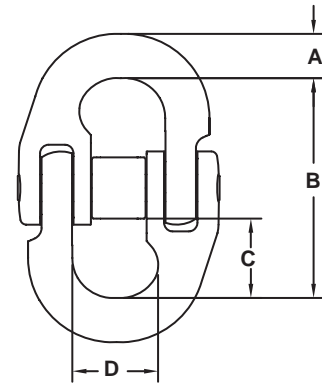

Size	Working Load Limit	Product Code	Load Pin kit Product Code	Dimensions				Weight
				A	B	C	D	
Imperial								
in.	lb.			in.	in.	in.	in.	lb.
9/32	3,500	664028-2	R664028-2	0.31	1.94	0.75	0.70	0.26
3/8	7,100	664038-2	R664038-2	0.50	2.41	0.88	0.91	0.59
1/2	12,000	664050-2	R664050-2	0.69	3.38	1.25	1.41	1.42
5/8	18,100	664062-2	R664062-2	0.81	4.06	1.50	1.70	2.35
3/4	28,300	664075-2	R664075-2	0.94	4.78	1.81	2.02	3.67
7/8	34,200	664089-2	R664089-2	1.05	5.13	2.00	2.25	5.98
1	47,700	664100-2	R664100-2	1.25	5.75	2.25	2.08	9.47
1 1/4	72,300	664125-2	R664125-2	1.53	6.81	2.63	2.92	16.61

Clevlok Sling Hook



- Available with and without a latch
- Quench and tempered alloy steel
- CM's clevlok head design
- 100% proof tested
- Fatigue rated
- Replacement pin and latch kit available
- Improved forged latch
- New CE compliant hooks and latches
- Meets EN 1677

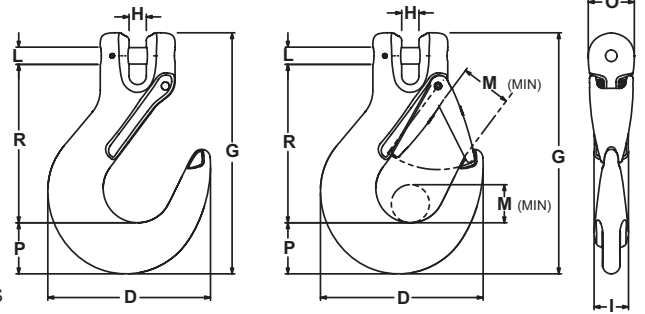

Overhead Lifting

Size	Working Load Limit	Product Code w/ latch	Product Code w/o latch	Latch Kit	Dimensions									Weight w/o latch	
					D	G	H	I	L	M	O	P	R		
Imperial															
in.	lb.				in.	in.	in.	in.	in.	in.	in.	in.	in.	in.	lb.
9/32	3,500	657318	557318	4X455322	3.53	5.23	0.38	0.75	0.36	0.83	1.00	1.11	3.44	1.20	
3/8	7,100	657319	557319	4X455325	4.38	6.53	0.47	0.97	0.51	1.06	1.16	1.36	4.32	2.21	
1/2	12,000	657320	557320	4X455328	5.48	8.03	0.58	1.18	0.63	1.38	1.50	1.61	5.35	4.22	
5/8	18,100	657321	557321	4X455329	6.20	8.43	0.71	1.44	0.75	1.69	1.74	1.92	6.12	6.64	
3/4	28,300	657322	553322	4X455330	7.09	10.80	0.88	1.81	0.94	2.09	2.00	2.08	7.25	11.22	

Eye Sling Hook



- Available with and without latch
- Quench and tempered alloy steel
- 100% proof tested
- Fatigue rated
- Replacement latch available

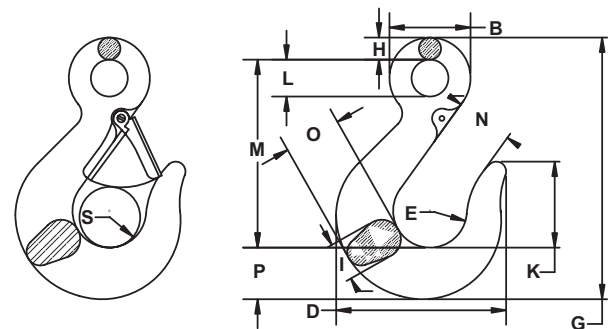

Size	Working Load Limit	Product Code w/ latch	Product Code w/o latch	Latch Kit	Dimensions												Weight w/o latch	
					B	D	E	G	H	I	K	L	M	N	O	P		S
Imperial																		
in.	lb.				in.	in.	in.	in.	in.	in.	in.	in.	in.	in.	in.	in.	in.	lb.
7/32	2,100	558544	458544	595461	--	3.31	1.44	4.30	.38	.78	1.25	.75	3.06	1.25	1.00	.86	1.11	0.66
9/32	3,500	558322	458722	595523	1.63	3.50	1.50	5.25	.44	.73	1.59	.75	3.75	1.19	1.20	1.05	1.06	1.10
3/8	7,100	558325	458725	595525	2.06	4.33	1.88	6.64	.56	.95	2.19	.94	4.78	1.44	1.45	1.28	1.31	1.90
1/2	12,000	558328	458728	595528	2.63	5.50	2.25	8.16	.75	1.17	2.56	1.13	5.69	1.78	1.94	1.66	1.63	4.30
5/8	18,100	558329	458729	595529	3.06	6.34	2.63	9.66	.88	1.44	2.63	1.31	6.50	2.03	2.38	2.19	1.75	7.30
3/4	28,300	558330	458730	595530	3.50	7.83	3.00	11.38	1.00	1.69	3.44	1.50	7.81	2.50	2.83	2.51	2.19	12.50
7/8	34,200	558332	458732	595532	3.88	8.59	3.38	12.72	1.09	1.94	3.88	1.69	8.75	2.78	3.22	2.84	2.38	18.10
1	47,700	558333	458733	595533	4.31	9.59	4.00	14.23	1.22	2.14	4.25	1.88	9.88	3.13	3.55	3.09	2.88	22.60
1-1/4	72,300	558335	458735	595535	5.31	11.56	4.66	17.00	1.50	2.62	4.64	2.31	11.50	3.88	4.25	3.89	3.41	47.00

HERC-ALLOY® Grab Hooks 800

Clevlok Grab Hook



- Quench and tempered alloy steel
- Fatigue rated
- Replacement pin available
- Built without lugs to avoid catching when slipping into tight clearance

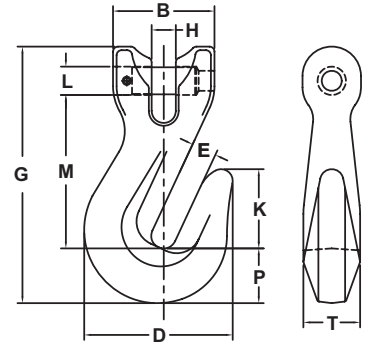

Size	Working Load Limit	Product Code	Load Pin	Retainer Pin	Dimensions										Weight
					B	D	E	G	H	K	L	M	P	T	
Imperial															
in.	lb.				in.	in.	in.	in.	in.	in.	in.	in.	in.	in.	lb.
9/32	3,500	659232	595780	602326	1.36	1.91	0.36	3.70	0.33	1.04	0.36	2.29	0.76	0.81	0.6
3/8	7,100	659235	595781	495821	1.90	2.78	0.47	4.81	0.45	1.49	0.51	2.87	1.03	1.06	1.3
1/2	12,000	659238	595782	495822	2.31	3.62	0.59	6.35	0.59	1.98	0.63	3.78	1.51	1.38	2.5
5/8	18,100	659239	595783	495823	2.87	4.41	0.75	7.74	0.75	2.39	0.75	4.82	1.80	1.69	4.4

Clevlok Cradle Grab Hook



- CM's unique cradle grab design
- Quench and tempered alloy steel
- Fatigue rated
- Replacement pin available

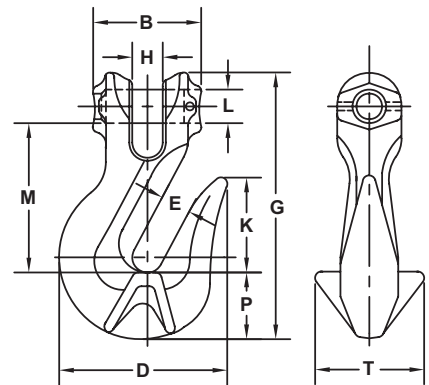

Size	Working Load Limit	Product Code	Dimensions										Weight		
			B	D	E	G	H	K	L	M	P	T			
Imperial															
in.	lb.		in.	in.	in.	in.	in.	in.	in.	in.	in.	in.	in.	in.	lb.
9/32	3,500	659222	1.31	1.78	.359	3.00	0.33	0.98	0.36	1.63	0.72	1.19	0.44		
3/8	7,100	659225	1.81	2.56	.469	4.08	0.45	1.41	0.51	2.11	1.06	1.75	1.18		
1/2	12,000	659228	2.16	3.25	.594	5.27	0.59	1.88	0.63	2.88	1.28	2.13	2.70		
5/8	18,100	659229	2.69	4.08	.750	6.53	0.75	2.38	0.75	3.56	1.59	2.50	4.60		
3/4	28,300	659430	3.09	4.91	.875	7.88	0.88	2.84	0.91	5.50	1.88	3.13	10.24		

Eye Cradle Grab Hook



- CM's unique cradle grab design
- Quench and tempered alloy steel
- 100% proof tested
- Fatigue rated

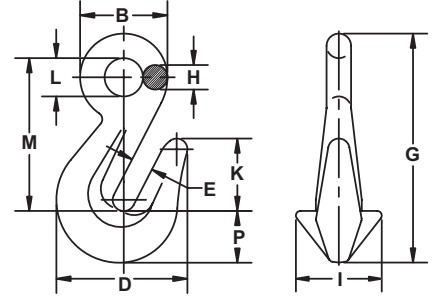

Overhead Lifting

Size	Working Load Limit	Product Code	Dimensions										Weight	
			B	D	E	G	H	I	K	L	M	P		
Imperial														
in.	lb.		in.	in.	in.	in.	in.	in.	in.	in.	in.	in.	in.	lb.
7/32	2,100	559318	1.19	1.75	0.36	2.69	0.38	1.19	0.96	0.63	1.63	0.7	0.35	
9/32	3,500	559325	1.38	1.91	0.36	3.70	0.38	1.06	1.04	0.63	2.57	0.76	0.55	
3/8	7,100	559337	1.78	2.78	0.47	4.81	0.50	1.38	1.49	0.78	3.28	1.04	1.06	
1/2	12,000	559350	2.28	3.63	0.59	6.19	0.63	1.81	1.98	1.03	4.22	1.51	2.00	
5/8	18,100	559362	2.75	4.41	0.75	7.62	0.75	2.13	2.39	1.25	5.06	1.80	5.40	
3/4	28,300	559575	3.19	5.23	0.88	8.99	0.88	2.88	3.50	1.44	6.25	1.88	9.00	
7/8	34,200	559387	3.75	5.69	1.00	9.63	1.00	3.00	3.75	1.75	6.50	2.12	10.40	
1	47,700	559100	4.31	7.00	1.19	12.44	1.22	3.88	4.31	1.88	8.09	3.12	20.90	
1-1/4	72,300	559124	5.38	8.25	1.50	15.56	1.56	2.50	5.50	2.25	10.50	3.50	40.00	

Eye Foundry Hook



- Throat opening up to 6"
- Quench and tempered alloy steel
- Fatigue rated to Grade 80 specifications

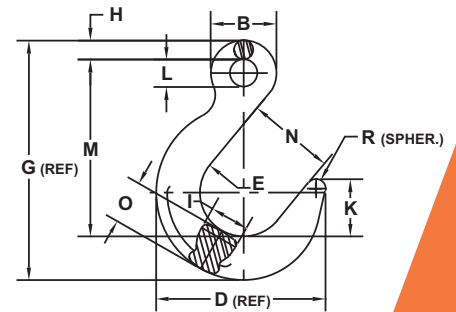

Size	Working Load Limit	Product Code	Dimensions											Weight	
			B	D	E	G	H	I	K	L	M	N	O		R
Imperial															
in.	lb.		in.	in.	in.	in.	in.	in.	in.	in.	in.	in.	in.	in.	in.
9/32	3,500	474498	1.56	4.75	2.50	6.45	0.47	1.00	1.56	0.63	4.75	2.50	1.23	0.25	2.4
3/8	7,100	474499	2.00	5.75	3.00	7.88	0.63	1.27	1.88	0.75	5.75	3.00	1.50	0.31	4.5
1/2	12,000	474500	2.50	6.75	3.50	9.38	0.75	1.50	2.22	1.00	6.88	3.50	1.75	0.38	7.1
5/8	18,100	474501	3.00	7.81	4.00	10.97	0.88	1.81	2.63	1.13	8.06	4.00	2.03	0.44	11.6
3/4	28,300	474502	3.50	9.13	4.50	12.81	1.00	2.20	3.00	1.50	9.25	4.50	2.56	0.50	20.0
7/8	34,200	474503	4.00	10.14	5.00	14.23	1.13	2.25	3.38	1.75	10.38	5.00	2.78	0.56	26.0
1	47,700	474504	4.50	11.13	5.50	15.84	1.25	2.59	3.75	2.13	11.56	5.50	3.03	0.62	36.8
1 1/4	72,300	474505	5.13	12.84	6.00	18.03	1.38	3.17	4.25	2.38	12.88	6.00	3.81	0.75	58.4

HERC-ALLOY® **800** *Sorting Hooks*

Sorting Hook



- Quench and tempered alloy steel
- Long tapered point designed for easy grab in rings, pear links, eyebolts or lifting holes
- Painted orange
- 5:1 design factor

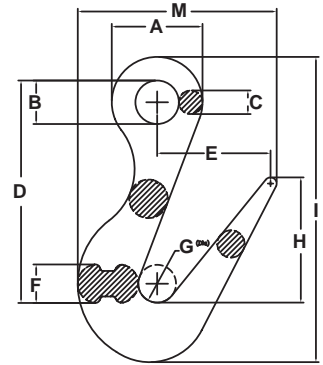

Product Code	WLL at Tip	WLL at bottom of hook	Dimensions										Weight	
			A	B	C	D	E	F	G	H	I	M		
Imperial														
	Ton	Ton	in.	in.	in.	in.	in.	in.	in.	in.	in.	in.	in.	lb.
M129	2	7.5	3	1.44	0.78	7.34	3.75	1.28	1.25	4.13	10.09	7.38	6.8	

Sorting Hook with Handle



- Quench and tempered alloy steel
- Added handle for easy removal from load
- Painted orange
- 5:1 design factor

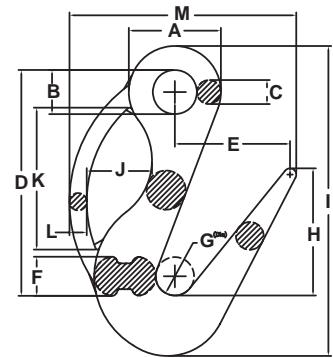

Product Code	WLL at Tip	WLL at bottom of hook	Dimensions												Weight	
			A	B	C	D	E	F	G	H	I	J	K	L		M
Imperial																
	Ton	Ton	in.	in.	in.	in.	in.	in.	in.	in.	in.	in.	in.	in.	in.	lb.
M129H	2	7.5	3	1.44	0.78	7.34	3.75	1.28	1.25	4.13	10.09	2.13	4.63	9.56	7.38	7.0

Plate Hook



- Made from alloy material
- Designed to handle plate steel
- Durable orange powder coat finish
- Available as components or attached to certified slings

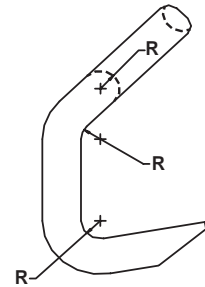
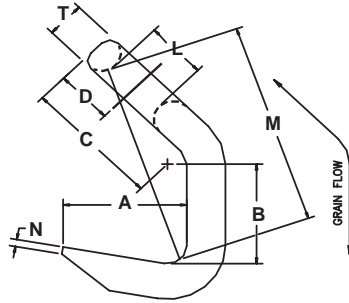

Size	Product Code	Working Load Limit	A	B	C	D	L	M	N	T	W	R	Weight
Imperial													
in.		lb.	in.	in.	in.	in.	in.	in.	in.	in.	in.	in.	lb.
9/32	462528	3,600	2.000	1.750	2.500	0.938	1.000	3.688	0.125	0.625	2.500	0.313	2.80
3/8	462537	7,050	2.625	3.000	4.313	1.188	1.125	6.375	0.188	0.750	2.750	0.375	5.70
1/2	462550	11,400	3.500	4.000	4.375	1.500	1.500	7.375	0.250	1.000	3.500	0.500	13.00
5/8	462562	17,800	4.375	5.000	5.438	1.875	1.875	9.250	0.313	1.250	5.000	0.625	26.50
3/4	462575	25,600	5.188	6.000	6.500	2.375	2.250	10.875	0.375	1.500	5.750	0.750	42.00
7/8	462587	34,900	6.000	7.000	7.625	2.500	2.625	13.062	0.438	1.750	6.000	1.000	65.00

"S" Hook



- Made from alloy material
- Proof tested at two times WLL
- Durable orange powder coat finish
- Custom sizes available upon request
- WLL embossed on links
- Serialized upon request

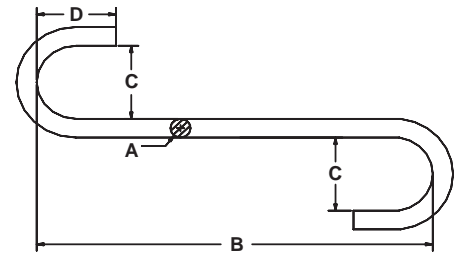

Product Code	Working Load Limit	Dimensions				Weight
		A	B	C	D	
Imperial						
	lb.	in.	in.	in.	in.	lb.
562228	210	0.281	4.500	1.125	1.125	0.15
562237	410	0.375	6.000	1.500	1.500	0.35
562250	870	0.512	7.500	2.000	2.000	0.82
562262	1,120	0.625	9.000	2.500	2.500	1.56
562275	1,730	0.750	10.500	3.000	3.000	2.6
562287	2,370	0.875	12.000	3.500	3.500	4.2
562300	2,920	1.000	13.000	4.000	4.000	6.0
562310	3,150	1.125	15.000	4.500	4.500	9.3
562325	4,450	1.250	16.000	5.000	5.000	11.7
562337	6,100	1.375	17.000	5.500	5.500	15.4
562350	6,250	1.500	18.000	6.000	6.000	19.5

Specialty Hooks



We can HOOK you up!

Materials

Steel
Bronze
Stainless Steel
High Manganese

Sizes

1/4" to 2" round bar
1/2" to 1-5/8" square bar
1/4" x 1" to 1" x 4" flat bar

Finishes

Self-colored
Zinc
Galvanized
Powder-coated
Silver 17

***Fabricate any hook
for any job
to your specifications***

Our custom alloy lifting hooks are available in a wide range of materials, including high manganese steel. This steel meets the rigorous requirements needed in high impact and abrasion applications.

Safety Directors and Supervisors are insisting on the use of certified hooks. We will provide overhead certification and proof testing for each custom piece upon request. We can also serialize and tag your order.

Stainless Steel Chain



- Made from 300 series stainless
- Higher temperature resistance than HA 800
- Safely used in the food handling industry
- Available components to build single and double slings
- Less corrosive than standard alloy material

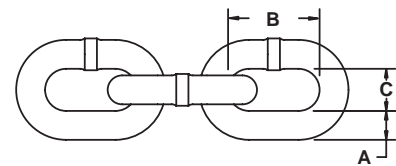

Chain Size	Working Load Limit	Product Code	Nominal Dim.			Approx. # of Links	Weight
			Material Diameter A	Inside Length B	Inside Width C		
Imperial							
in.	lb.		in.	in.	in.		lb.
9/32	2,000	646028	0.281	0.868	0.415	13.8	0.74
3/8	3,550	646037	0.394	1.222	0.580	9.8	1.45
1/2	6,500	646050	0.512	1.404	0.740	8.5	2.58

Wear Allowances of Stainless Steel

Measure cross section at link ends to determine wear. If chain is worn to less than the minimum allowable thickness, remove from service.

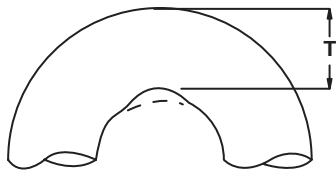

Chain Size		Minimum Allowable Thickness (T)	
In.	mm	In.	mm
9/32	7	0.239	6.1
3/8	10	0.342	8.7
1/2	13	0.443	11.2

Use of Chain & Components Under Extreme Temperature Conditions

When the chain itself is subjected to temperatures shown here, working load limits should be reduced as indicated.

Temperature		Reduction of Working Load Limit	
		While at Temperature	After Exposure to Temperature
°F	°C		
Below 400	Below 204	None	None
400-800	204-426	10%	None
801-1000	427-537	20%	None
1001-1200	538-649	30%	None
1201-1300	650-704	40%	None
1301-1400	705-760	50%	None
1401-1500	761-815	60%	None
1501-1600	816-871	75%	None

HERC-ALLOY® Stainless Steel 800

Stainless Steel Master Link



- Made from 300 series stainless
- Retains strength in high temperatures
- Designed to be used with stainless steel chain
- 100% proof tested

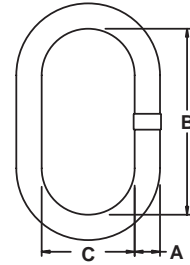

Trade Size	Working Load Limit	Product Code	Nominal Dim.			Weight
			Material Diameter A	Inside Length B	Inside Width C	
Imperial						
in.	lb.			in.	in.	lb.
1/2	4,000	555550	0.500	5.00	2.50	0.79
3/4	7,100	555575	0.750	5.50	2.75	2.03
1	13,000	555600	1.000	7.00	3.50	4.59