



CATEGORY DEFINITION

Since 1823, Norton has been the leading supplier of conventional and diamond benchstones, waterstones, sharpening systems, files, slips and specialty stones for industrial, commercial and DIY sharpening applications. Our comprehensive line of sharpening and finishing products is the industry's broadest line with premier performance and quality.

- APPLICATIONS:** Deburring, dimensioning, sharpening, honing
- GRIT RANGE:** Coarse, Medium, Fine, Extra Fine, Ultra Fine
- ABRASIVE TYPES:** Aluminum Oxide (India) , Silicon Carbide (Cryston) , Arkansas (Soft and Hard Translucent), and Diamond

APPLICATION-TO-PRODUCT RECOMMENDATION GUIDE

Benchstones

	Coarse/Medium Sharpening	Fine Stoning	Finish Honing
Chip Breakers	–	Fine Crystonol Benchstone	–
Draw Knives	Coarse Crystonol Benchstone	Fine India Benchstone	Hard Arkansas Benchstone
Scrapers	Coarse Crystonol Benchstone	Fine India Benchstone	Hard Arkansas Benchstone
Chisels (Wood)	Coarse Crystonol Benchstone 1000 Waterstone	Fine India Benchstone 4000 Waterstone	Hard Arkansas Benchstone 8000 Waterstone
Plane Blades	Coarse Crystonol Benchstone 1000 Waterstone	Fine India Benchstone 4000 Waterstone	Hard Arkansas Benchstone 8000 Waterstone

Slips

	Coarse/Medium Sharpening	Fine Stoning
Milling Cutter	Medium India Round Edge Slip	Fine India Round Edge Slip
Carbide Tools		Fine Crystonol Slip for Carbide Tools

Abrasive Files

	Coarse/Medium Sharpening	Fine Stoning	Finish Honing
Form Cutter	Coarse or Medium India Knife Blade	Fine India Knife Blade	–
Keyways	Coarse or Medium India Square File	Fine India Square File	–
Lathe Bits	Medium India Square File	Fine India Square File	–
Radius Tools	Medium India Round File	Fine India Round File	–
Reamers	Medium India Reamer Stone	Fine India Reamer Stone	–
Router Bits	–	Fine India Square File	–
Saws	Coarse India Triangular File	Fine India Tapered Triangular File	–
Center Punches	Medium India Triangular File	Fine India Triangular File	–
Magnetic Chucks	Medium Crystonol Round File	Fine India Round File	–
Molding Cutters*	Coarse or Medium India File	Fine India File	–
Countersinks	Coarse India Triangular File	Fine India Triangular File	Hard Arkansas Triangular File
Tap Threads	–	Fine India Triangular File	–

* SELECT SHAPE TO FIT CONFIGURATION



Relative Sharpening Comparisons for Norton Products

CRYSTOLON (SILICON CARBIDE) INDIA (ALUMINUM OXIDE)	ARKANSAS (SOFT, HARD TRANSLUCENT)	DIAMOND STONES	WATERSTONES		COATED ABRASIVES (WATERPROOF SANDPAPER)		DIAMOND COMPOUND
			JIS (JAPAN)	CAMI (USA)	FIPA (EUROPE)	MICRON SIZE	
Coarse Crystolon						P100	141
						P120	127
							116
Coarse India						P150	97
							93
							78
Medium Crystolon		Extra Coarse Diamond (220)	Norton 220			P180	65
						P220	60
						P240	58
Medium India						P280	53.5
							52.5
							50
Fine Crystolon		Coarse Diamond (325)				P320	46
							45
							43
Fine India						P360	40.5
							36
							35
						P400	29
							25.8
							23
	Soft Arkansas	Fine Diamond (600)	600			P800	22
							20
							16
			800			P1200	14
							12.6
							11
			Norton 1000			P1500	10.3
							9.2
							9
						P2000	8.4
							7.5
							6
	Hard Translucent Arkansas		Norton 4000				5
							3
							1.2
			Norton 8000				1
							0.5
			15000				

FEATURED PRODUCTS

Benchstones



PRECISION BENCHSTONES

BETTER CHOICE FOR SHARPENING TOOLS AND KNIVES

FEATURES AND APPLICATIONS

- Jewelers' Benchstones – These stones are excellent for sharpening the fine, precision cutting tools used by jewelers, engravers and artisans.
- Penknife Precision Benchstones – Ideal for sharpening cutting tools, laboratory blades, surgical instruments, engravers' and die makers' tools, and pocket knives to the keenest edge.

AVAILABILITY

TIER: BETTER

SIZE (L x W x H)	QTY./ PKG.	QTY./ CASE	SPEC.	PRODUCT #	PART #
Precision Benchstones – Jewelers'					
4 x 2 x 3/8	1	5	Ultra Fine – Hard Translucent Arkansas	HB24	61463687525
6 x 2 x 3/8	1	5	Ultra Fine – Hard Translucent Arkansas	HB26	61463687530
Precision Benchstones – Penknife					
3 x 1 x 3/8	5	10	Extra Fine – Soft Arkansas	SB13	61463687560
			Ultra Fine – Hard Translucent Arkansas	HB13	61463687550
4 x 1 x 3/8	5	10	Extra Fine – Soft Arkansas	SB14	61463687565
			Ultra Fine – Hard Translucent Arkansas	HB14	61463687555



Benchstones CONTINUED

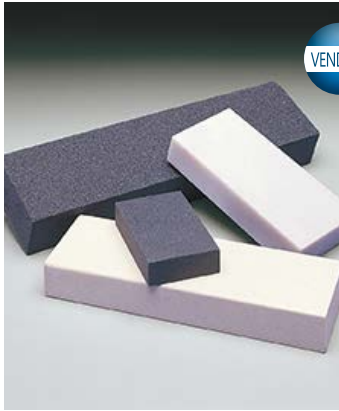

VENDIBLE

SINGLE GRIT ABRASIVE BENCHSTONES BETTER CHOICE FOR EDGE SHAPING AND HONING

FEATURES

- Crystolon – Premium silicon carbide abrasive
- India – Smooth cutting aluminum oxide abrasive; our best product for a fine finish
- Arkansas – Natural premium Novaculite quarried in Arkansas and available in Soft or Hard Translucent

BENEFITS

- Fast cutting stone; ideal for general sharpening of cutting tools
- Fast stock removal for quick edge shaping with minimal loading
- Long lasting cutting edge
- The choice of artisans, craftsmen and mechanics
- Ideal for clean deburring, generating keen edges and quality finishes
- Sharpest possible razor edges
- Near mirror finishes
- Use for finer honing after India stone

AVAILABILITY

TIER: BETTER

SIZE (L x W x H)	QTY./ PKG.	QTY./ CASE	SPEC.	PRODUCT #	PART #
Single Grit Benchstones – Crystolon (Silicon Carbide)					
4 x 1 x 1/4	1	5	Coarse	CJB14	61463685470
	1	5	Medium	MJB14	61463685465
	1	5	Fine	FJB14	61463685460
	5	5	Fine	FJB14-V	66253325915+
4 x 1 x 1/2	1	5	Coarse	CJB24	61463685485
	1	5	Medium	MJB24	61463685480
	1	5	Fine	FJB24	61463685475
5 x 2 x 5/8	1	5	Medium	MJB35	61463685495
	1	5	Fine	FJB35	61463685490
6 x 2 x 1	1	5	Coarse	CJB6	61463685510
	1	5	Medium	MJB6	61463685505
	1	5	Fine	FJB6	61463685500
8 x 2 x 1	1	5	Coarse	CJB8	61463685525
	1	5	Medium	MJB8	61463685520
	1	5	Fine	FJB8	61463685515
8 x 3 x 1/2	5	5	Coarse	CJB83-V	61463654459*
	5	5	Medium	MJB83-V	61463654458*
	5	5	Fine	FJB83-V	61463654457*
11-1/2 x 2-1/2 x 1/2	1	1	Coarse	JM3	61463685980#
	1	1	Medium	JM6	61463685975#
Single Grit Benchstones – Soft Arkansas					
4 x 2 x 3/4-1	1	5	Extra Fine	SB4	61463685670
6 x 2 x 3/4-1	1	5	Extra Fine	SB6	61463685675
8 x 2 x 3/4-1	1	5	Extra Fine	SB8	61463685680

✓ = VENDIBLE PACKAGE. IDEAL FOR VENDING MACHINES, SMALL JOBS, AND CARRYING TO JOB SITE. PRE-PACKED IN STURDY BOXES OF 5 PER PACK. ORDER BY TOTAL NUMBER OF STONES NEEDED; NOT BY QUANTITY OF PACKS.

* MAY BE USED AS REPLACEMENT STONE FOR IM-83 SHARPENING SYSTEM.

MAY BE USED AS REPLACEMENT STONE FOR IM-313 SHARPENING STONE SYSTEM.

AVAILABILITY

TIER: BETTER

SIZE (L x W x H)	QTY./ PKG.	QTY./ CASE	SPEC.	PRODUCT #	PART #
Single Grit Benchstones – India (Aluminum Oxide)					
4 x 1 x 1/4	1	5	Coarse	CB14	61463685580
	1	5	Medium	MB14	61463685575
	1	5	Fine	FB14	61463685570
	5	5	Fine	FB14-V	66253325919
4 x 1 x 1/2	1	5	Coarse	CB24	61463685595
	1	5	Medium	MB24	61463685590
	1	5	Fine	FB24	61463685585
5 x 2 x 5/8	1	5	Medium	MB35	61463685605
	1	5	Fine	FB35	61463685600
6 x 2 x 1	1	5	Coarse	CB6	61463685620
	1	5	Medium	MB6	61463685615
	1	5	Fine	FB6	61463685610
8 x 2 x 1	1	5	Coarse	CB8	61463685635
	1	5	Medium	MB8	61463685630
	1	5	Fine	FB8	61463685625
8 x 3 x 1/2	5	5	Coarse	CB83-V	61463654462*
	5	5	Medium	MB83-V	61463654461*
	5	5	Fine	FB83-V	61463654460*
11-1/2 x 2-1/2 x 1/2	1	1	Coarse	IM6	61463654214#
	1	1	Medium	IM9	61463685970#
Single Grit Benchstones – Hard Translucent Arkansas					
4 x 2 x 3/4-1	1	5	Ultra Fine	HB4	61463685655
6 x 2 x 3/4-1	1	5	Ultra Fine	HB6	61463685660
8 x 2 x 3/4-1	1	5	Ultra Fine	HB8	61463685665
8 x 3 x 1/2	5	5	Ultra Fine	HTB83-V	61463654464*
11-1/2 x 2-1/2 x 1/2	1	1	Ultra Fine	HM11	61463685965#



Benchstones CONTINUED



COMBINATION GRIT ABRASIVE BENCHSTONES

BETTER CHOICE FOR ECONOMICAL SOLUTION FOR GENERAL SHARPENING AND FINISHING WITH ONE STONE

FEATURES AND APPLICATIONS

- **Crystolon Combination**
Coarse and fine grit sharp-cutting silicon carbide abrasive surfaces for general sharpening (to moderate tolerances) when the speed of sharpening is more important than the fineness of the cutting edges. Gray in color.
- **India Combination**
Coarse and fine grit aluminum oxide abrasive surfaces produce strong, keen, long-lasting edges on quality tools. Orange/brown in color.
- **Crystolon/India Combination**
Fast-sharpening, medium grit silicon carbide (Crystolon) and fine aluminum oxide (India) abrasive surfaces for keen, long-lasting edges on quality tools. Crystolon side is dark gray in color, India side is orange.
- **Giant Combination Stones**
11-1/2" and 12" bench oil stones are used to sharpen large edge tools with long sweeping strokes.

AVAILABILITY

SIZE (L x W x H)	QTY./ PKG.	QTY./ CASE	SPEC.	TIER:	BETTER
				PRODUCT #	PART #
Combination Grit Benchstones – Crystolon (Silicon Carbide)					
4 x 1 Round	1	5	Coarse/Fine	JB64	61463685435
4 x 1-3/4 x 5/8	1	5	Coarse/Fine	JB134	61463685440
5 x 2 x 3/4	1	5	Coarse/Fine	JB45	61463685445
6 x 2 x 1	1	5	Coarse/Fine with Anniversary Box	JB6	61463685450
8 x 2 x 1	1	5	Coarse/Fine with Anniversary Box	JB8	61463685455
11-1/2 x 2-1/2 x 1	1	2	Coarse/Fine	JUM3	61463685840
12 x 2-1/2 x 1-1/2	1	2	Coarse/Fine	JUM4	61463685855
Combination Grit Benchstones – India (Aluminum Oxide)					
4 x 1 Round	1	5	Coarse/Fine	IB64	61463685545
4 x 1-3/4 x 5/8	1	5	Coarse/Fine	IB134	61463685550
5 x 2 x 3/4	1	5	Coarse/Fine	IB45	61463685555
6 x 2 x 1	1	5	Coarse/Fine with Anniversary Box	IB6	61463685560
8 x 2 x 1	1	5	Coarse/Fine with Anniversary Box	IB8	61463685565
11-1/2 x 2-1/2 x 1	1	2	Coarse/Fine	IM2	61463685851
Combination Grit Benchstones – Crystolon/India					
6 x 2 x 1	1	5	Medium/Fine	IC6	61463685643
11-1/2 x 2 x 1	1	2	Medium/Fine	IC11	61463687239
Oil Stone Instructional Dvd					
N/A	1	1	Oil Stone DVD		07660787945

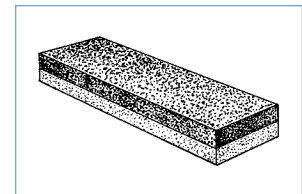

APPLICATION-TO-PRODUCT RECOMMENDATION GUIDE

	FAST CUT STOCK REMOVAL	INITIAL SHARPENING	FINAL SHARPENING	HONING	SHARPEST EDGE
Grit Size	Coarse	Medium	Fine	Extra Fine	Ultra Fine
Abrasive	Crystolon	Crystolon	India	Soft Arkansas	Hard Arkansas
Product/Color	Grey	Grey	Orange	Milky White	Translucent



Instructional DVD Offering

Waterstone: 07660787944
Oil Stone: 07660787945

Ideal for sales training and end-user self-study. Learn to efficiently use these sharpening products to maintain tools at peak performance and prolong their life – to make all your sharpening, honing, etc. applications easier.



Waterstones

Waterstones are synthetic stones designed to be softer than oil stones. These softer grade stones are used with water as the lubricant (versus oil) to develop a fast cutting slurry. The Norton Waterstone system was designed in a carefully planned sequence to create sharpening efficiency. You get the level of abrasiveness you need at each stage, without wasting time trying to sharpen your tools on a grit that is too fine, too soon.



WATERSTONES

BETTER CHOICE FOR PRODUCING SUPERIOR EDGES ON PLANES AND STRAIGHT CHISELS

FEATURES

- System of four synthetic “Japanese-type” stones designed to work together, with water
- Softer than traditional oilstones – providing lapping action
- Color-coded by grit

BENEFITS

- Fast sharpening, fine finish
- Superb results with low pressure
- Easy to differentiate grit size



PREP STONE

BETTER CHOICE FOR RAISING SLURRY

FEATURES

- This synthetic stone raises the slurry

BENEFITS

- Speeds up the slurry-making process needed to cut and polish with waterstones

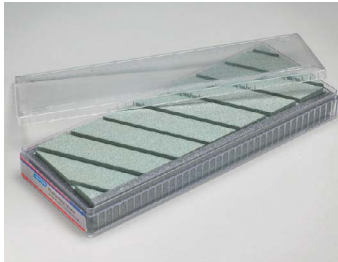

FLATTENING STONE

BETTER CHOICE FOR PRODUCING FLAT SURFACES ON WATERSTONES

FEATURES

- Coarse grit silicon carbide stone
- Diagonal grooves
- Superbly flat with hard bond

BENEFITS

- Promotes maximum cutting for all grit sizes of waterstones
- Provide swarf removal
- Produces extremely flat results on all waterstones

AVAILABILITY

TIER: **BETTER**

SIZE (L x W x H)	QTY./ PKG.	QTY./ CASE	SPEC.	PART #
Waterstones – Single Grit (Bulk-Packed)				
8 x 3 x 1	1	5	220	61463689505
	1	5	1000	61463689506
	1	5	4000	61463689507
	1	5	8000	61463689508
Set	1	1	4 Stones: 220, 1000, 4000, 8000 Grit	61463624334
Waterstones – Combination Grit (Bulk-Packed)				
8 x 3 x 1	1	5	220 / 1000	61463624335
	1	5	1000 / 4000	61463624450
	1	5	1000 / 8000	69936655039
	1	5	4000 / 8000	61463624336
Prep Stone				
20mm x 20mm x 3"	1	5	Aluminum Oxide	66243439361
Flattening Stone				
9 x 3 x 3/4	1	5	Silicon Carbide	69936687444
Waterstone Kit				
N/A	1	1	Kit includes: 1-220/1000 and 1-4000/8000 waterstone, 1 flattening stone and 1 instructional DVD	07660787943
Waterstone Instructional DVD				
N/A	1	1	Waterstone DVD	07660787944

TECHtip

MAXIMIZING WATERSTONE PERFORMANCE

- Wet waterstone
- Rub evenly with the prep stone to create slurry
- Evening off the high spots will make for less-frequent flattening of the waterstones
- Waterstones wear concave with use; periodically flatten with flattening stone



Diamond Benchstones

Made in the USA, these benchstones have unique stackable non-skid rubber feet designed to keep the diamond plate steady while you sharpen, and efficiently stacked for space-saving storage when not in use. Our simple grit-size color-coding makes them easy to differentiate.

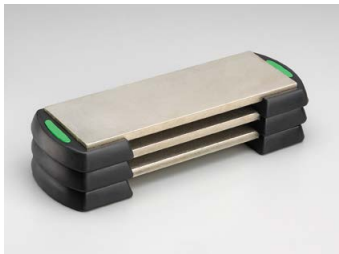

STACKABLE DIAMOND BENCHSTONES

BETTER CHOICE FOR PRODUCING SUPERIOR EDGES ON PLANES AND STRAIGHT CHISELS

FEATURES

- Made in the USA
- Flat, diamond surface plated onto a nickel-coated steel bar precision ground to a tolerance of .001"
- Even diamond distribution; continuous diamond sharpening surface
- Available in 3 grit sizes: 220 (red), 325 (blue), 600 (green), and 2 sizes: 6" and 8"
- Color-coded tabs on stones and packaging
- Stackable; the stones firmly stack on top of each other
- Non-skid rubber base

BENEFITS

- Quality industrial diamonds and workmanship
- Fast, even blade and tool edge sharpening
- Easily lubricated with water, but oil may be used
- Excellent sharpening performance across entire surface of stone
- Quicker sharpening than conventional interrupted-surface diamond stones
- Pointed tools will not snag, as on interrupted-surface diamond stones
- Ideal for all your large and small tool sharpening and finishing needs
- Easy identification of grit sizes for use and displaying
- Easy, small-profile storage
- Stays in place while sharpening for smoother, efficient sharpening

AVAILABILITY

SIZE WITH RUBBER FEET (L x W x H)		QTY./PKG.	QTY./CASE	TIER: SPEC.	BETTER PART #
Stackable Diamond Benchstones					
6 x 2 x 1/4*	1	5	D220		66253268082
6 x 2 x 1/4*	1	5	D325		66253268081
6 x 2 x 1/4*	1	5	D600		66253268080
8 x 2 x 1/4	1	5	D220		66253268087
8 x 2 x 1/4	1	5	D325		66253268086
8 x 2 x 1/4	1	5	D600		66253268083



6" STONES COME RETAIL PACKAGED

Sharpening Stone Oil



SHARPENING STONE OIL

BETTER CHOICE FOR IMPROVING SHARPENING STONE PERFORMANCE

FEATURES

- Norton oil is a highly refined lubricating oil
- Meets U.S. Pharmacopoeia standards for mineral oil purity

BENEFITS

- Specifically formulated for sharpening stone use
- Equally ideal for all lubricating jobs
- It will not load or "gum-up" sharpening stones
- May be used around food preparation operations

AVAILABILITY

SIZE	QTY./PKG.	QTY./CASE	TIER: SPEC.	BETTER PRODUCT #	PART #
Sharpening Stone Oil					
4-1/2 oz.	1	20	Oil	XB1	61463687760
1 Pint	1	20	Oil	XB5	61463687770
1 Quart	1	5	Oil	XB2	61463687775

TECHtip

- All oil stones are porous in nature; oil is required to keep the pores open and working efficiently
- Use Norton oil to optimize the performance of Crystolon, India and Arkansas stones
- While sharpening knives, blades and tools, be careful to keep fingers away from sharp edges



Sharpening Systems

Tri-Stone Systems

The base of the tri-stone system acts as an oil reservoir permitting continuous submersion of the unused stones, keeping them clean and saturated, ready for immediate use and years of utility. Rotating the handle brings the desired stone into position for sharpening. All offer a range of replacement stones to replace worn or damaged stones, or substitute different specifications to customize the system.



IM313 MULTI-OILSTONE SHARPENING SYSTEM

BETTER CHOICE FOR LARGE, STRAIGHT-EDGED TOOL SHARPENING

FEATURES AND BENEFITS

- Considered by many to be the ultimate sharpening system, the IM313 contains three oil stones. The 11-1/2" stone length permits long, sweeping strokes for faster and more precise sharpening and honing of all large, wider straight-edged tools. The heavy base has a non-skid bottom.
- A pint of Norton oil, plastic angle guide, and reservoir unit are included with each IM313 system. For general sharpening – coarse Crystolon quickly restores worn edges; medium Crystolon produces the average edge needed for most tools; and fine India stone hones for a sharper edge.



IM200 PROFESSIONAL SHARPENING SYSTEM

BETTER CHOICE FOR A VERSATILE, MULTI-SIZE TOOL AND KNIFE SHARPENER

FEATURES AND BENEFITS

- The smaller 8" stone IM200 system provides the same quality sharpening features as the IM313 – making it the perfect choice for small restaurants and home DIYers.
- The system contains 4-1/2 oz. of lubricating oil, plastic angle guide, and the reservoir unit. For general sharpening – coarse Crystolon quickly restores worn edges; medium Crystolon produces the average edge needed for most tools; and fine India stone hones for a sharper edge.



IM100 3-IN-1 TOOL AND KNIFE SHARPENING SYSTEM

BETTER CHOICE FOR SMALL STRAIGHT-EDGED TOOL SHARPENING

FEATURES AND BENEFITS

- The smallest system, designed for general sharpening, the IM100 is an affordable choice for small knives, cutlery, and woodworking tools.
- 4-1/2 oz. of lubricating oil and a reservoir unit complete the system. For general sharpening – coarse Crystolon quickly restores worn edges; medium Crystolon produces the average edge needed for most tools; and fine India stone hones for a sharper edge.

Portable Sharpening Systems



IM83 PORTABLE SHARPENING STONE SYSTEM

BETTER CHOICE FOR ALL SHARPENING ENTHUSIASTS WHO CARRY THEIR SYSTEM WITH THEM

FEATURES AND BENEFITS

- Sturdy metal latches secure the cover and storage case – where small tools can be housed. The IM83 is designed like all our other sharpening systems; the stones can be replaced to customize the unit to individual requirements.
- Ideal for industrial toolrooms, restaurants, knife manufacturers, DIYers, and sportsmen.
- Both IM83 systems include 3 sharpening stones, an instructional DVD in the base, and a reservoir carrying case. The oil stone system also includes 4-1/2 oz. oil.
- IM83-W Portable Waterstone System – Tool Repair to Fine Finishes
This portable sharpening system is equipped with a carefully engineered sequence of waterstones for clean, efficient sharpening. The waterstones can easily be maintained with the flattening stone provided.
- IM83-O Portable Oil Stone System – Straight-Edged Tool Sharpening
The coarse silicon carbide (Crystolon) stone in this system repairs damaged edges quickly; the medium aluminum oxide (India) stone imparts a durable, smooth cutting edge; and the fine aluminum oxide (India) stone provides the final sharpening and polishing stage.





Sharpening Systems CONTINUED

AVAILABILITY

SIZE	QTY./ PKG.	QTY./ CASE	SPEC.	TIER:	BETTER
				PRODUCT #	PART #
IM313 Multi-Oilstone Sharpening System					
11-1/2 x 2-1/2 x 1/2	1	1	1 Coarse Crystolon, 1 Medium Crystolon, 1 Fine India, 1 Pint Oil, Angle Guide, Reservoir Unit		IM313 61463685960
IM200 Professional Sharpening System					
8 x 2 x 3/8	1	1	1 Coarse Crystolon, 1 Medium Crystolon, 1 Fine India, 4-1/2 oz. Oil, Angle Guide, Reservoir Unit		IM200 61463691260
IM100 3-in-1 Tool and Knife Sharpening System					
6 x 2 x 1/2	1	1	1 Coarse Crystolon, 1 Medium Crystolon, 1 Fine India, 4-1/2 oz. Oil, Reservoir Unit		IM100 61463685356
IM83 Portable Systems					
8 x 3 x 1/2	1	1	Oilstones: 1 Coarse Crystolon, 1 Medium India, 1 Fine India, 4-1/2 oz. Oil, Instructional DVD in Base, Reservoir Carrying Case		IM83-O 66243582823
8 x 3 x 1	1	1	Waterstones: 1 ea. of 1000, 4000, 8000 Grit, 1 Flattening Stone, Instructional DVD in Base, Reservoir Carrying Case		IM83-W 66243582825

FOR SHARPENING SYSTEM REPLACEMENT STONES: SEE SINGLE GRIT BENCHSTONE CHARTS ON PAGE 53, OR YOUR NORTON REPRESENTATIVE FOR REPLACEMENT STONES AND PARTS WHICH MAY BE USED AS REPLACEMENTS OR TO CUSTOMIZE YOUR SYSTEM.

Abrasive Files

Norton abrasive files hold their shape while imparting the finest, most uniform finish on precision machine parts and in tool and die making. They are ideal for any deburring, chamfering or radiusing job, or for filing delicate parts. Select the file shape that matches the contour of the surface being stoned.

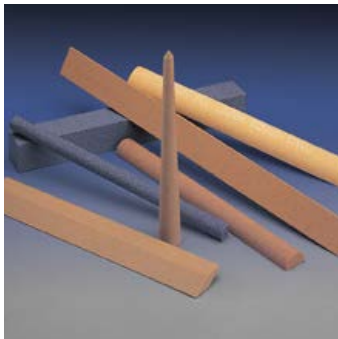

ABRASIVE FILES

BETTER CHOICE FOR ANY DEBURRING, CHAMFERING OR RADIUSING JOB, OR FOR FILING DELICATE PARTS

FEATURES AND APPLICATIONS

- Crystolon Files – Fast-acting silicon carbide products, Crystolon files are designed for use where moderate tolerances are acceptable, and speed of sharpening is more important than fineness.
- India Files – India files are ideal when close tolerance, and strong, keen, long-lasting edges are needed.
- Hard Translucent Arkansas Files – Hard Arkansas has an ultra fine grit that produces the finest edge possible while maintaining tolerances unequalled by any other abrasive file. It will also produce a highly polished finish.

Square Abrasive Files

Square File applications range from dimensioning keyways to maintain fit, stoning faces on router bits, touching-up edges of reamer teeth, and lapping/honing to close tolerances to produce the finest edge on precision instruments, die work and delicate tools.



AVAILABILITY

SIZE (L x H)	QTY./ PKG.	QTY./ CASE	SPEC.	TIER:	BETTER
				PRODUCT #	PART #
Square Abrasive Files – Crystolon (Silicon Carbide)					
4 x 3/8	5	5	Fine	FJF34	61463686030
4 x 1/2	5	5	Medium	MJF44	61463686045
			Fine	FJF44	61463686040
Square Abrasive Files – Hard Translucent Arkansas					
3 x 1/4	5	5	Ultra Fine	HF13	61463686590
3 x 3/8	5	5	Ultra Fine	HF33	61463686595
3 x 1/2	5	5	Ultra Fine	HF43	61463686600

ALL SQUARE FILES ARE BULK PACKED

AVAILABILITY

SIZE (L x H)	QTY./ PKG.	QTY./ CASE	SPEC.	TIER:	BETTER
				PRODUCT #	PART #
Square Abrasive Files – India (Aluminum Oxide)					
4 x 1/4	5	5	Coarse	CF14	61463686075
			Medium	MF14	61463686070
			Fine	FF14	61463686065
4 x 3/8	5	5	Coarse	CF34	61463686090
			Medium	MF34	61463686085
			Fine	FF34	61463686080
4 x 1/2	5	5	Coarse	CF44	61463686105
			Medium	MF44	61463686100
			Medium	MF44-V	66253325913
			Fine	FF44	61463686095
6 x 1/2	5	5	Coarse	CF46	61463686120
			Medium	MF46	61463686115
			Fine	FF46	61463686110
6 x 5/8	5	5	Medium	MF56	61463686130
			Fine	FF56	61463686125
6 x 3/4	5	5	Coarse	CF66	61463686150
			Medium	MF66	61463686145
			Fine	FF66	61463686140
6 x 1	5	5	Coarse	CF76	61463686165
			Medium	MF76	61463686160
			Fine	FF76	61463686155

✓ = VENDIBLE PACKAGE. IDEAL FOR VENDING MACHINES, SMALL JOBS, AND CARRYING TO JOB SITE. PRE-PACKED IN STURDY BOXES OF 5 PER PACK. ORDER BY TOTAL NUMBER OF STONES NEEDED; NOT BY QUANTITY OF PACKS.



Abrasive Files CONTINUED

Triangular Abrasive Files

Triangular Files are used for a variety of deburring, chamfering and radiusing applications including cleaning tap threads, stoning cutting surfaces of milling cutters, lapping honing tools, dies and molds, and putting precision points on center punches.

The India line also offers Tapered Triangles, used by mechanics and tool and die makers to impart the correct edge in the least time.

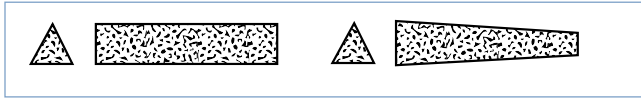

AVAILABILITY

SIZE (L x H)		QTY./ PKG.	QTY./ CASE	SPEC.	PRODUCT #	PART #
Triangular Abrasive Files – Crystolon (Silicon Carbide)						
4 x 1/4	5	5	Fine	FJF114	61463686185	
4 x 1/2	5	5	Fine	FJF144	61463686205	
Triangular Abrasive Files – Hard Translucent Arkansas						
3 x 1/4	5	5	Ultra Fine	HF113	61463686620	
3 x 3/8	5	5	Ultra Fine	HF133	61463686625	
3 x 1/2	5	5	Ultra Fine	HF143	61463686630	

ALL TRIANGULAR FILES ARE BULK PACKED

Round Abrasive Files

Half Round Files offer both a round and a flat surface for imparting a fine finish on precision machine parts, tools and dies.

Round Files are ideal for deburring, chamfering, radiusing, lapping, honing, cleaning radius tools to a burr-free edge, and dimensioning compound curves on templates.

Round Pointed Files are ideally suited for engravers and die sinkers for stoning difficult recesses on instruments and die tools.

Round Tapered Files are used by craftsmen, woodworkers, and die makers as their unique shape imparts the correct edge quickly.

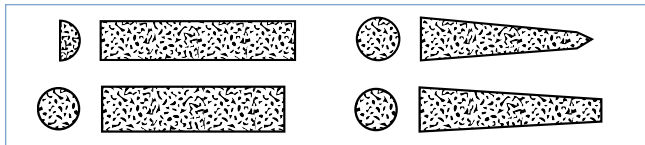

AVAILABILITY

SIZE (L x D)		QTY./ PKG.	QTY./ CASE	SPEC.	PRODUCT #	PART #
Half Round Abrasive Files – India (Aluminum Oxide)						
4 x 1/4	5	5	Medium	MF314	61463686355	
	5	5	Fine	FF314	61463686350	
4 x 3/8	5	5	Medium	MF334	61463686385	
	5	5	Fine	FF334	61463686380	
4 x 1/2	5	5	Coarse	CF344	61463686405	
	5	5	Medium	MF344	61463686400	
	5	5	Fine	FF344	61463686395	

ALL HALF-ROUND AND ROUND FILES ARE BULK PACKED

AVAILABILITY

SIZE (L x H)		QTY./ PKG.	QTY./ CASE	SPEC.	PRODUCT #	PART #
Triangular Abrasive Files – India (Aluminum Oxide)						
4 x 1/4	5	5	Coarse	CF114	61463686240	
	5	5	Medium	MF114	61463686235	
	5	5	Fine	FF114	61463686230	
4 x 3/8	5	5	Coarse	CF134	61463686255	
	5	5	Medium	MF134	61463686250	
	5	5	Fine	FF134	61463686245	
4 x 1/2	5	5	Coarse	CF144	61463686270	
	5	5	Medium	MF144	61463686265	
	5	5	Fine	FF144	61463686260	
6 x 1/2	5	5	Coarse	CF146	61463686285	
	5	5	Medium	MF146	61463686280	
	5	5	Fine	FF146	61463686275	
6 x 5/8	5	5	Medium	MF156	61463686295	
	5	5	Fine	FF156	61463686290	
6 x 3/4	5	5	Medium	MF166	61463686310	
	5	5	Fine	FF166	61463686305	
6 x 1	5	5	Medium	MF176	61463686325	
	5	5	Fine	FF176	61463686320	
Triangular Tapered Abrasive Files – India (Aluminum Oxide)						
4 x 1/2 x 1/4	5	5	Medium	MF544	61463686685	
	5	5	Fine	FF544	61463686680	

AVAILABILITY

SIZE (L x D)		QTY./ PKG.	QTY./ CASE	SPEC.	PRODUCT #	PART #
Round Abrasive Files – Crystolon (Silicon Carbide)						
4 x 1/4	5	5	Medium	MJF214	61463686430	
	5	5	Fine	FJF214	61463686425	
4 x 3/8	5	5	Medium	MJF234	61463686440	
Round Abrasive Files – India (Aluminum Oxide)						
4 x 1/4	5	5	Coarse	CF214	61463686480	
	5	5	Medium	MF214	61463686475	
	5	5	Fine	FF214	61463686470	
4 x 3/8	5	5	Coarse	CF234	61463686495	
	5	5	Medium	MF234	61463686490	
	5	5	Fine	FF234	61463686485	
4 x 1/2	5	5	Coarse	CF244	61463686510	
	5	5	Medium	MF244	61463686505	
	5	5	Fine	FF244	61463686500	
6 x 1/2	5	5	Coarse	CF246	61463686525	
	5	5	Medium	MF246	61463686520	
	5	5	Fine	FF246	61463686515	
6 x 5/8	5	5	Medium	MF256	61463686535	
6 x 3/4	5	5	Medium	MF266	61463686550	
6 x 1	5	5	Medium	MF276	61463686565	
Round Abrasive Files – Hard Translucent Arkansas						
3 x 1/4	5	5	Ultra Fine	HF813	61463686800	
Round Pointed Abrasive Files – India (Aluminum Oxide)						
3 x 5/16 Base	5	5	Coarse	CF723	61463686750	
	5	5	Medium	MF723	61463686745	
	5	5	Fine	FF723	61463686740	
Round Pointed Abrasive Files – Hard Translucent Arkansas						
3 x 1/4 Base	5	5	Ultra Fine	HF863	61463686825	
Round Tapered Abrasive Files – India (Aluminum Oxide)						
4 x 1/2 x 1/4	5	5	Coarse	CF644	61463686660	
	5	5	Medium	MF644	61463686655	
	5	5	Fine	FF644	61463686650	



Abrasive Files CONTINUED

Diamond-shaped Abrasive Files

Diamond-shaped Files are precision sharpening favorites for cleaning acute angles in dies and molds, and for stoning geometric chasers and sewing machine feeds.



AVAILABILITY		TIER:		BETTER		
SIZE (L x W x H)	QTY./ PKG.	QTY./ CASE	SPEC.	PRODUCT #	PART #	
Diamond-Shaped Abrasive Files – India (Aluminum Oxide)						
4 x 9/16 x 3/16	5	5	Coarse	CT134	61463686720	
	5	5	Medium	MT134	61463686715	
	5	5	Fine	FT134	61463686710	
Diamond-Shaped Abrasive File – Hard Translucent Arkansas						
3 x 1/2 x 3/16	5	5	Ultra Fine	HF843	61463686815	

ALL DIAMOND-SHAPED FILES ARE BULK PACKED

Beveled Abrasive Files

Beveled Files are preferred by exacting artisans, jewelers, mechanics, and watchmakers for honing the finest of finishes. These extremely hard files provide years of service.



AVAILABILITY		TIER:		BETTER		
SIZE (L x W x H)	QTY./ PKG.	QTY./ CASE	SPEC.	PRODUCT #	PART #	
Beveled Abrasive File – Hard Translucent Arkansas						
3 x 3/8 x 1/8	5	5	Ultra Fine	HF833	61463686810	

ALL BEVELED FILES ARE BULK PACKED

Flat Abrasive Files

The Flat File is the choice of mechanics, artisans and jewelers. This long lasting file produces the finest finishes.



AVAILABILITY		TIER:		BETTER		
SIZE (L x W x H)	QTY./ PKG.	QTY./ CASE	SPEC.	PRODUCT #	PART #	
Flat Abrasive File – Hard Translucent Arkansas						
3 x 3/8 x 1/8	5	5	Ultra Fine	HF823	61463686805	

ALL FLAT FILES ARE BULK PACKED

Oval Abrasive Files

The Oval File's shape makes it ideal for finishing and honing recesses or curved edges of precision instruments.



AVAILABILITY		TIER:		BETTER		
SIZE (L x W x H)	QTY./ PKG.	QTY./ CASE	SPEC.	PRODUCT #	PART #	
Oval Abrasive File – Hard Translucent Arkansas						
3 x 1/2 x 3/16	5	5	Ultra Fine	HF853	61463686820	

ALL OVAL FILES ARE BULK PACKED

Knife Blade Abrasive Files

Knife Blade Files are used by clock and watch makers to quickly sharpen, hone, and maintain the edges and points of cutting tools.



AVAILABILITY		TIER:		BETTER		
SIZE (L x W x H)	QTY./ PKG.	QTY./ CASE	SPEC.	PRODUCT #	PART #	
Knife Blade Abrasive Files – India (Aluminum Oxide)						
4 x 1 x 1/8 Back	5	5	Coarse	CF724	61463686780	
	5	5	Medium	MF724	61463686775	
	5	5	Fine	FF724	61463686770	
Knife Blade Abrasive File – Hard Translucent Arkansas						
3 x 3/4 x 1/8	5	5	Ultra Fine	HF873	61463686830	

ALL KNIFE BLADE FILES ARE BULK PACKED

Abrasive File Sets

Hard Translucent Arkansas File Set

This set provides a selection of our most popular square, triangular, round and knife blade files in ultra fine Hard Translucent Arkansas for honing and polishing a wide range of configurations.

Hard Translucent Arkansas-India File Set

This set contains an assortment of files for finishing, honing and polishing applications. It contains a selection of the most popular square, triangular, round and knife blade files in both fine grit India and ultra fine grit Hard Translucent Arkansas.

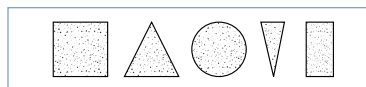

AVAILABILITY		TIER:		BETTER		
SIZE (L x W x H)	QTY./ PKG.	QTY./ CASE		PRODUCT #	PART #	
File Set – Hard Translucent Arkansas						
	1	1			61463686839	
1 Each of Ultra Fine Hard Arkansas HF13, HF113, HF813, and HF873						
File Set – Hard Translucent Arkansas and India (Aluminum Oxide)						
	1	1			61463686840	
1 Each of Ultra Fine Hard Arkansas HF13, HF43, HF113, HF813, HF873, and Fine India FF14, FF44, FF114, FF214, FF724						

See the “Norton Professional Sharpening Products and Dressing Sticks Catalog #200” on www.nortonstones.com to view the complete list and descriptions of our many sharpening products.



Abrasive Files CONTINUED

Engravers' Chuck & Points

Engravers' Points are the choice of professional die-makers for cleaning tight corners and recesses where close tolerances and accuracy are a must. The Engravers' Chuck is a knurled nickel-plated tool designed to hold the Engravers' Point.

AVAILABILITY

SIZE (L x POINT)	QTY./ PKG.	QTY./ CASE	SPEC.	TIER: BETTER	
				PRODUCT #	PART #
Engravers' Chuck					
Engravers' Chuck	5	5		XT1	61463687485
Engravers's Point – India (Aluminum Oxide)					
1 x 1/8 Point	5	5	Fine	FT11	61463687495
Engravers's Point – Soft Arkansas					
1 x 1/8 Point	5	5	Extra Fine	AT11	61463687490

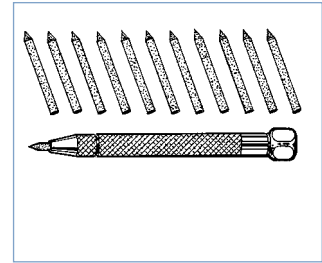

Silversmith Precision Files

These aluminum oxide precision-shaped stones are designed for use by silversmiths and mechanics for close tolerance lapping, touching-up instruments, and for cleaning tools and dies.

AVAILABILITY

SIZE	QTY./ PKG.	QTY./ CASE	SPEC.	TIER: BETTER	
				PRODUCT #	PART #
Silversmith Precision Files – India (Aluminum Oxide)					
4 x 5/16 x 3/16 x 5/16 x 1/16 - X	5	5	Medium	MF414	61463686855
	5	5	Fine	FF414	61463686850
4 x 3/8 x 3/16 x 1/8 x 1/16 - Y	5	5	Medium	MF424	61463686915
	5	5	Fine	FF424	61463686910
4 x 7/16 x 3/16 x 1/8 - BB	5	5	Fine	FF434	61463686940
4 x 1/2 x 1/16 - BB	5	5	Coarse	CF444	61463686965
	5	5	Medium	MF444	61463686960
	5	5	Fine	FF444	61463686955
4 x 1/2 x 1/4 x 5/16 x 1/8 - DD	5	5	Fine	FF464	61463686985
4 x 1/2 x 1/4 x 5/16 x 1/8 - EE	5	5	Medium	MF474	61463687005
	5	5	Fine	FF474	61463687000

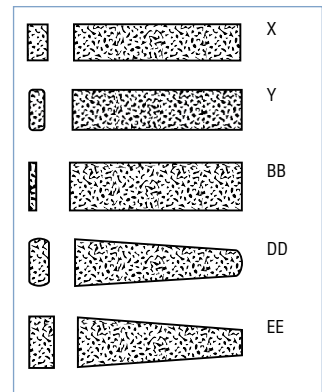

Pocket Stones



POCKET STONES

BETTER CHOICE FOR OUTDOOR ENTHUSIASTS

FEATURES AND BENEFITS

- Convenient and easily transported
- Ideal for outdoor enthusiasts to sharpen scissors, knives, axes, etc.
- Available in a protective case

AVAILABILITY

SIZE (L x W x H)	QTY./ PKG.	QTY./ CASE	SPEC.	TIER: BETTER	
				PRODUCT #	PART #
Pocket Stone – India Sportsman (Aluminum Oxide)					
3 x 1-1/2 x 1/2	50	50	Coarse/Fine	IBP34	61463690705
Pocket Stone – India (Aluminum Oxide)					
4 x 3/4 x 1/4	25	25	Fine	IBP4	61463624153
Pocket Stone with Case – India (Aluminum Oxide)					
3 x 7/8 x 3/8 with case	50	50	Fine	FBP3	61463691122
Pocket Stone with Case – Crystalon (Silicon Carbide)					
3 x 7/8 x 3/8 with case	50	50	Fine	JP14	61463690703
Pocket Stone with Case – Soft Arkansas					
4 x 1 x 3/4 with case; in retail package	5	5	Extra Fine		66253142544
Fish Hook Stone With Pouch – Crystalon Half-Round (Silicon Carbide)					
3" x 1/2" with Pouch	50	50	Fine		61463624072



Abrasive Slips



ABRASIVE SLIPS

BETTER CHOICE FOR IMPARTING FINE, UNIFORM FINISHES

FEATURES AND BENEFITS

- Norton abrasive slips impart the finest, most uniform finishes on curved knives and tools, molders' knives, wood gouges, bead planers, and carbide-tipped tools. These fast-acting slips hold their shape and are long lasting.
- The Crystolon and India stones are designed for preliminary sharpening and the Norton Hard Translucent Arkansas stones are the choice for achieving the finest finish possible.

Carbide Tool Slips

Crystolon (silicon carbide) Slips are used to maintain the edge of carbide tools – keeping regrinding costs and time to an absolute minimum. Not oil-filled.

Round Edge Slips

Round Edge Slips are ideal for precision sharpening and honing of bead planers, curved knives and tools, molders' knives and wood gouges.



AVAILABILITY

TIER: **BETTER**

SIZE	QTY./ PKG.	QTY./ CASE	SPEC.	PRODUCT #	PART #
Carbide Tool Slips – Crystolon (Silicon Carbide)					
3-1/2 x 3/4 x 1/2	5	5	Coarse	CJT63	61463687295
	5	5	Medium	MJT63	61463687290
	5	5	Fine	FJT63	61463687285
Set of Three Above	5	5	Coarse, Medium & Fine	J63	61463687300
Carbide Tool Slips – India (Aluminum Oxide)					
2-1/4 x 7/8 x 3/16	5	5	Medium	MS12	61463687215
Round Edge Slips – Crystolon (Silicon Carbide)					
4-1/2 x 1-3/4 x 1/4 x 1/16	5	5	Medium	MJS24	61463687080
	5	5	Fine	FJS24	61463687075
4-1/2 x 1-3/4 x 1/2 x 3/16	5	5	Coarse	CJS44	61463687100
	5	5	Medium	MJS44	61463687095
	5	5	Fine	FJS44	61463687090
6 x 2-1/4 x 3/4 x 3/8	5	5	Medium	MJS66	61463687110
	5	5	Fine	FJS66	61463687105
Round Edge Slips – India (Aluminum Oxide)					
4 x 1 x 7/16 x 3/16	5	5	Medium	MS14	61463687140
	5	5	Fine	FS14	61463687135
4-1/2 x 1-3/4 x 1/4 x 1/16	5	5	Coarse	CS24	61463687155
	5	5	Medium	MS24	61463687150
	5	5	Fine	FS24	61463687145
4-1/2 x 1-3/4 x 3/8 x 1/8	5	5	Coarse	CS34	61463687170
	5	5	Medium	MS34	61463687165
	5	5	Fine	FS34	61463687160
4-1/2 x 1-3/4 x 1/2 x 3/16	5	5	Coarse	CS44	61463687185
	5	5	Medium	MS44	61463687180
	5	5	Fine	FS44	61463687175
5 x 1 x 5/16 x 3/32	5	5	Medium	MS15	61463687195
	5	5	Fine	FS15	61463687190
Round Edge Slips – Soft Arkansas					
4 x 1-3/4 x 3/8 x 1/8	5	10	Extra Fine	SS4	61463687055
Round Edge Slips – Hard Translucent Arkansas					
3 x 1-3/4 x 1/4 x 1/16	5	10	Ultra Fine	HS3	61463687040
4 x 1-1/4 x 1/4 x 1/8	5	10	Ultra Fine	HS14	61463687050
4 x 1-3/4 x 3/8 x 1/8	5	10	Ultra Fine	HS4	61463687045

Specialty Stones



SPECIALTY STONES

BETTER CHOICE FOR SPECIFIC SHARPENING OR DEBURRING APPLICATIONS

FEATURES AND BENEFITS

- Norton continues to offer specialty stones with optimum specifications and unique shapes that conform to, and quickly sharpen, specific tools



Specialty Stones CONTINUED

Specialty Stones for Machine Tools

Gouge Sharpening Stone

This stone has a unique shape for sharpening and lapping inside and outside curved surfaces on gouges and other cutting tools.

Jointer Stones

These stones provide a fast method of restoring and maintaining the cutting edges of mechanical jointing devices on automatic planers.

Machine Knife Stone

Crystolon (silicon carbide) machine knife stones offer both coarse and fine sides for sharpening and honing paper and cloth-cutting knives and planer knives on the machine. The groove around the middle of the stone protects fingers and provides a secure hold.

Reamer Stones

Durable, fast-cutting stones designed for imparting a professional edge on reamers, taps, and rough rounders on shoe machine tools.

Boat Stones

Boat Stones are medium grit, medium grade stones that are easy to hold and use. Excellent for deburring and breaking sharp edges on dies, fixtures and machined parts, and for deburring grinder magnetic chucks.

AVAILABILITY

SIZE	QTY./ PKG.	QTY./ CASE	SPEC.	TIER: BETTER	
				PRODUCT #	PART #
Gouge Sharpening Stone – India (Aluminum Oxide)					
6 x 2 x 1 x 1/2 x 3/8	5	5	Fine	FS76	61463687305
Jointer Stones					
4 x 3/4 x 3/8 – Crystolon (Silicon Carbide)	5	5	Medium	JE74	61463687335
4 x 3/4 x 3/8 – India (Aluminum Oxide)	5	5	Coarse	IE74	61463687375
4 x 3/4 x 1/2 – Crystolon (Silicon Carbide)	5	5	Medium	JE84	61463687340
Machine Knife Stone – Crystolon (Silicon Carbide)					
4" Diam. x 1-1/2" Thick	5	5	Coarse/Fine	JB74	61463687570
Reamer Stones – India (Aluminum Oxide)					
4-1/2 x 1 x 5/16	10	10	Medium	MT124	61463687420
	10	10	Fine	FT124	61463687415
5 x 1 x 3/16	10	10	Medium	MT125	61463687430
	10	10	Fine	FT125	61463687425
6 x 1 x 1/4	10	10	Medium	MT126	61463687440
	10	10	Fine	FT126	61463687435
Boat Stone – Crystolon (Silicon Carbide)					
9 x 2-1/2 x 1-1/2	10	10	37C80-HV		61463610369
Boat Stone – India (Aluminum Oxide)					
9 x 2-1/2 x 1-1/2	10	10	38A60-IVBE		61463610503

BOAT STONES ARE BULK PACKED

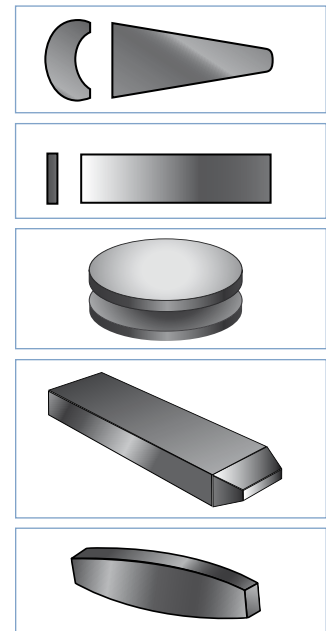

Large Specialty Stones

Tradesmen's Utility Stones

Used for sharpening trimming knives and as an abrasive file in many different industries. The JT910 does not have a handle, while the JT920 and JT930 have wooden handles.

Sickle and Scythe Stones

These silicon carbide stones quickly produce a fast-cutting edge on sickles, scythes, and brush hooks. These stones are most frequently chosen where the speed of sharpening is the primary consideration.

Utility File

A long wedge-shaped stone with four flat sides designed for sharpening coarse cutting edges on cutting implements and edged garden tools. Wooden handles make them easy to use. They will outlast and out-sharpen metal files.

AVAILABILITY

SIZE	QTY./ PKG.	QTY./ CASE	SPEC.	TIER: BETTER	
				PRODUCT #	PART #
Tradesmen's Utility Stones – Crystolon (Silicon Carbide)					
10 x 1-1/4 x 3/4 (Bulk-Packed)	10	10	Medium	JT910	61463687665
14-3/4 Overall (w/ Handle)	10	10	Coarse/Fine	JT930	61463687675
	10	10	Medium	JT920	61463687670
Sickle and Scythe Stones					
10 x 1-1/4 x 3/4 Crystolon (Silicon Carbide)	10	10	Coarse	TJ3	61463687731
10 x 1-5/16 x 3/4 India (Aluminum Oxide)	10	10	Coarse	TD1	61463687715
Utility File – Crystolon (Silicon Carbide) (Bulk-Packed)					
14 Overall (w/ Handle)	10	10	Coarse	JD2	61463687750

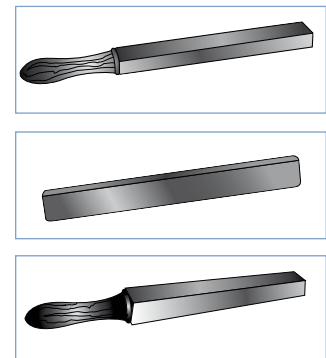



Retail Packaged Sharpening Products

Our retail-packaged line brings Norton quality to your distributor showroom, vending machine, tool crib, and your tool box. Each stone is specifically designed for a popular sharpening application and packaged to sell or carry to the job site.



AVAILABILITY

SIZE (L x W x H)	SPEC.	TIER:	BETTER
		QTY./CASE	PART #
Axe and Hatchet Sharpener			
3 x 5/8 round	Coarse/Fine Crystolon (Silicon Carbide)	10	07660785316
Pocket Knife Sharpener			
3 x 7/8 x 3/8	Fine Crystolon (Silicon Carbide)	5	07660787600
3 x 7/8 x 3/8 with case	Medium India (Aluminum Oxide)	5	07660787937
3 x 1-1/2 x 1/2 with case	Coarse/Fine India (Aluminum Oxide)	5	07660787630
Economy Tool & Knife Benchstone			
6 x 2 x 3/4	Coarse/Fine Crystolon (Silicon Carbide)	5	07660787933
8 x 2 x 3/4	Coarse/Fine India (Aluminum Oxide)	10	07660787934
8 x 2 x 1	Coarse/Fine India (Aluminum Oxide)	10	61463685755
High Quality Tool & Knife Benchstone			
6 x 2 x 3/4	Coarse/Fine Crystolon (Silicon Carbide)	5	07660787935
Chisel & Planer Blade Sharpener			
8 x 2 x 3/4	Coarse/Fine India (Aluminum Oxide)	10	07660787936
Household Knife & Tool Sharpener			
7-1/2	Fine Crystolon (Silicon Carbide)	5	07660787939
Farm Tool Sharpener			
10 x 1-1/4 x 3/4	Coarse Crystolon (Silicon Carbide)	10	07660787730
Lawn & Garden Tool Sharpener			
9-1/2 x 1-3/8 x 1/2	Medium Crystolon (Silicon Carbide)	10	07660787938
Sharpening Stone Oil			
4-1/2 oz.	Oil	5	07660787940
Sharpening Steel			
1/2 x 10	Round file with rubber handle	8	66253240433



Knife and Scissor Sharpener

The knife and scissor mechanical sharpener is a quick and portable tool for hundreds of sharpening applications.

SPECIFICATION	QTY./CASE	PART #
Knife and Scissor Sharpener		
Carbide	6	07660787520

Norton Professional Sharpening Products and Dressing Sticks

See the "Norton Professional Sharpening Products and Dressing Sticks Catalog #200" on www.nortonstones.com to view the complete list and descriptions of our many sharpening products.