



EMEA Product and Brand Overview

Date: December, 2017

Prepared By: A. Tolga Kirmaci

Market Manager EMEA - Hand Tools

FORGE AHEAD

The Back-Story

Since its revolutionary inception in the mid 1990's, GearWrench® has proven itself to be a force to be reckoned with in the tool industry. The original GearWrench® ratcheting wrench is now a tool box necessity for almost every professional tool user. Scores of innovative new products, designed to provide a solution for nearly any task, are being introduced every year. We make it our business to know the challenges you face on the job so we can create the tools that help you get the job done faster.

GearWrench® has always focused on continuous improvement in three areas: speed, strength, and access. Using the latest Voice-of-Customer techniques and our proprietary Inventor Connect program, we listen to pro tool users to learn how we can design tools that better answer their needs. As a result, the majority of new GearWrench products begin development because of direct customer feedback. So keep talking to us, and we'll keep listening and designing better products to help make your job go faster and easier.



Brand Blueprint

BRAND			OUR BEHAVIORS																				
Our Purpose			Proving Product Performance Building Community and Collaboration Delivering Value																				
What we Offer Tools to deliver speed, strength, access to provide the highest productivity	How we Act Pursuing Performance Together	Why we Exist We Believe in Technician First																					
Our Brand Values Collaborative / Responsive / Innovative / Obsessive / Straight-Talking / Proactive																							
Audiences Technicians > Employees Industrial End Users > Street / Summit Team			Communications Confident Relevant Authentic Connected Energetic Straight Professional Talking																				
Our Brand Benefits <table border="0"> <tr> <td>Rational</td> <td></td> <td>Emotional</td> <td></td> </tr> <tr> <td>Speed</td> <td>Warranty</td> <td>Respect</td> <td>Smart</td> </tr> <tr> <td>Strength</td> <td>Value</td> <td>Pride</td> <td>Inspired</td> </tr> <tr> <td></td> <td>Access</td> <td></td> <td>Empowered</td> </tr> <tr> <td></td> <td>Service</td> <td></td> <td>Freedom</td> </tr> </table>			Rational		Emotional		Speed	Warranty	Respect	Smart	Strength	Value	Pride	Inspired		Access		Empowered		Service		Freedom	
Rational		Emotional																					
Speed	Warranty	Respect	Smart																				
Strength	Value	Pride	Inspired																				
	Access		Empowered																				
	Service		Freedom																				

Sub-Category Overview

Fastening, Striking, Struck, Pry Bars // Sub-category Overview

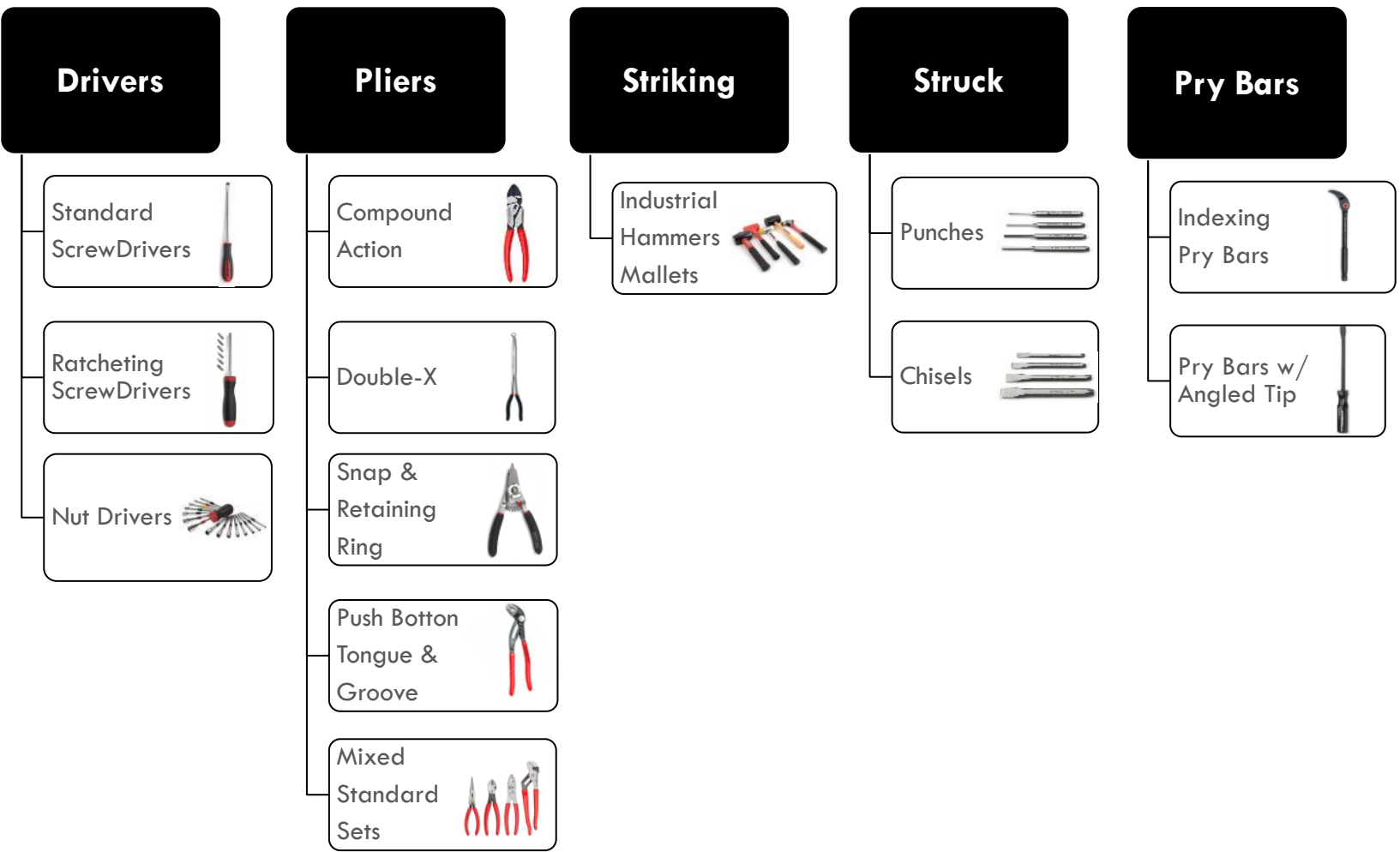

Sub-Category Overview

Forming & Shaping, MHT, Auto Specialty, Storage // Sub-category Overview

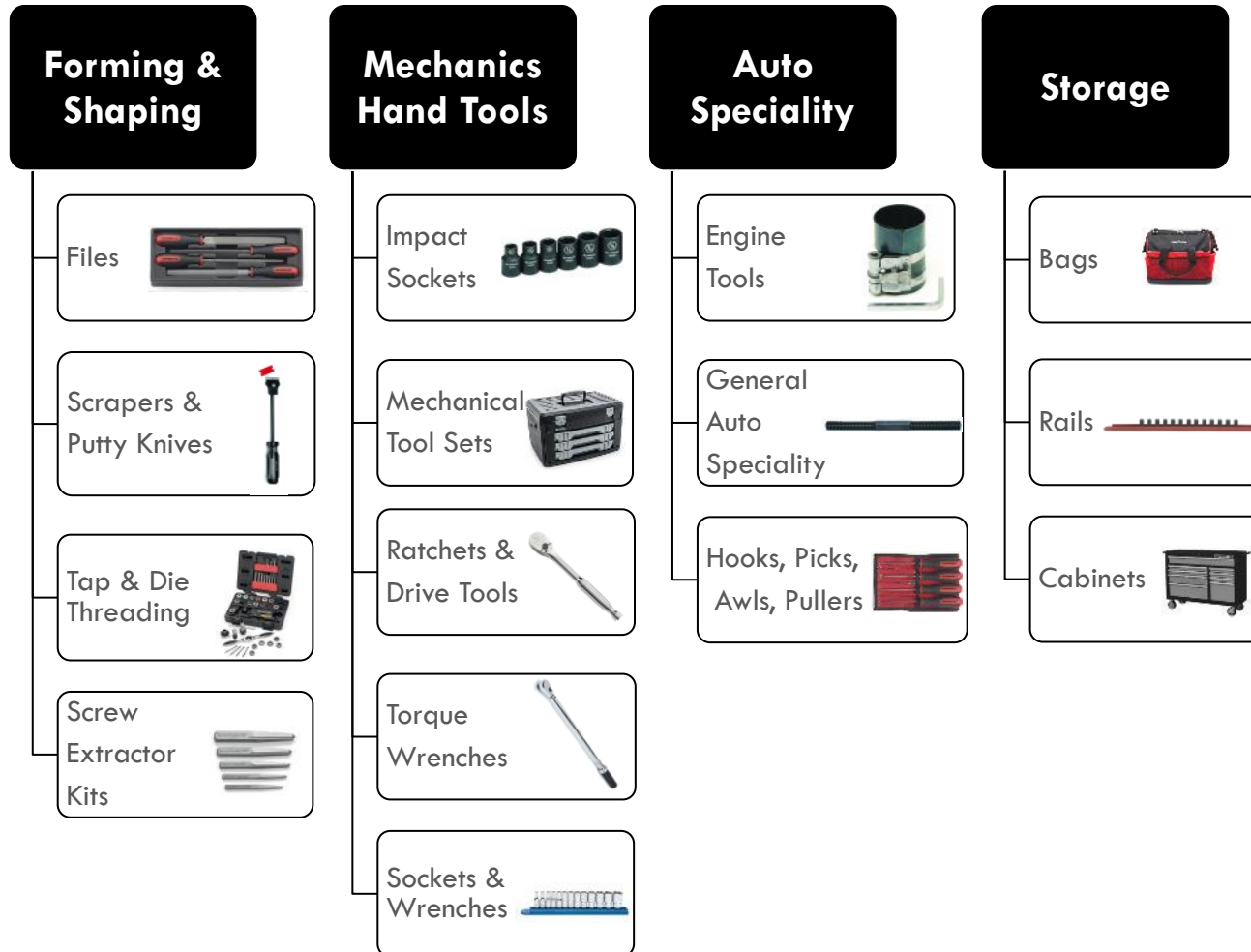

Drivers



Drivers

Ratcheting Screwdriver Set – 40 Pcs.

Product Information

Catalog No	8940
Features & Benefits	<ul style="list-style-type: none"> ▪ Oil and Solvent Resistant ▪ Flexible and Solid Drive Shafts ▪ Premium S2 Quality Steel Bits ▪ Contoured, Dual Material Comfort Grip ▪ Precision, Fine Tooth, Reversible Ratcheting Mechanism ▪ Includes A Straight Handle, Stubby Handle, and T-Handle



Access

- Interchangeable shafts allow access to nearly any fastener

Productivity

- 8" reversible ratcheting mechanism
- Ratcheting or non-ratcheting mode

Design

- Dual durometer ergonomic shape handle helps reduce fatigue and improve grip and high torque

Design

- Removable end cap allows convenient storage for up to 12 bits



890001GD - Ratcheting Screwdriver Straight Handle

Drivers

Ratcheting GearDriver™ Screwdriver Set – 7 Pcs.

Product Information

Catalog No	82781
Features & Benefits	<ul style="list-style-type: none">▪ Contoured, Dual Material Comfort Grip▪ Oil and Solvent Resistant▪ Precision, Fine Tooth, Reversible Ratcheting Mechanism▪ Premium S2 Quality Steel Bits▪ Phillips®/Slotted



Drivers

2-Position Ratcheting Screwdriver with LED lights

Product Information

Catalog No 82788

- Features & Benefits
- 45-Tooth Ratcheting Mechanism with Forward, Reverse and Lock Positions
 - Storage for 6 Bits in Handle
 - Requires (3) 1.5V Batteries, Included
 - 2-Position Handle - Straight or Pistol Grip
 - 2 LED Lights to Illuminate Work Area
 - Phillips Bits #1, #2
 - Star Bits T-15, T-20, T-25, T-27
 - 4-1/2" Shaft Provides Access
 - Stainless Steel Collar Magnetizes Bit Tip to Hold Screw



Drivers

Dual Material Screwdriver Sets

Product Information

- | | |
|--------------------------------|--|
| Features & Benefits | <ul style="list-style-type: none"> ▪ "Speed Zone" for Turning in Lower Torque Applications ▪ Innovative Dual Material Handle for Comfort and Performance ▪ Oil and Solvent Resistant ▪ Tri-Lobe Ergonomic Handle to Obtain Optimal ▪ Balance of Strength and Comfort Black Oxide Non-Slip Tip ▪ Laser Etched Part Number and Size ▪ Meets or Exceeds ASME B107.15 |
|--------------------------------|--|

Art. No	Description
80050	6 Pc. Combination Dual Material Screwdriver Set
80051	12 Pc. Combination Dual Material Screwdriver Set
80052	5 Pc. Phillips Dual Material Screwdriver Set
80066	20 Pc. Master Dual Material Screwdriver Set



80052



80050



80066

Drivers

Easy-To-Identify Screwdriver Sets

Product Information

- | | |
|---------------------|--|
| Features & Benefits | <ul style="list-style-type: none"> ▪ "Speed Zone" for Turning in Lower Torque Applications ▪ Innovative Dual Material Handle for Comfort and Performance ▪ Oil and Solvent Resistant ▪ Tri-Lobe Ergonomic Handle to Obtain Optimal ▪ Balance of Strength and Comfort Black Oxide Non-Slip Tip ▪ Open Stock Items are also available ▪ Meets or Exceeds ASME B107.15 |
|---------------------|--|



Art. No	Description
---------	-------------

- | | |
|-------|--|
| 82682 | 8ps Orange Combination Screwdriver Set |
| 82683 | 8ps Green Combination Screwdriver Set |

Style	Tip Size	Hex Bolster	Blade Length	Overall Length
Slotted Cabinet	3/16"	No	3"	7"
Slotted	1/4"	No	1.5"	4.1"
Slotted	1/4"	Yes	4"	8.7"
Slotted	5/16"	Yes	6"	11.25"
Phillips	#1	No	3"	7"
Phillips	#2	No	1.5"	4.1"
Phillips	#2	Yes	4"	8.7"
Phillips	#3	Yes	6"	11.25"

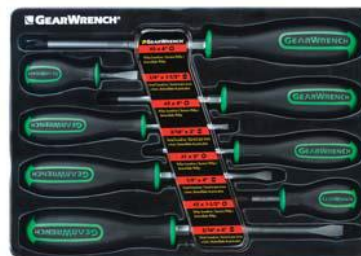

Drivers

Long & Extra Long Screwdriver Sets

Product Information

- | | |
|---------------------|--|
| Features & Benefits | <ul style="list-style-type: none"> ▪ Long & Extra Long Blades for Access ▪ Black Oxide Non-Slip Tip ▪ Laser Etched Part Number and Size ▪ Innovative Dual Material Handle for Comfort and Performance ▪ Oil and Solvent Resistant ▪ Tri-Lobe Ergonomic Handle to Obtain Optimal Balance of Strength and Comfort ▪ Meets or Exceeds ASME B107.600-2008 |
|---------------------|--|

Art. No	Description
---------	-------------

80068	2Pc 24" Extra Long Screwdriver Set
80069	4Pc 16" Long Screwdriver Set



1/4" x 24" Slotted Dual Material Screwdriver
#2 x 24" Phillips® Dual Material Screwdriver

#2 x 20" Phillips® Dual Material Screwdriver
3/8" x 20" Slotted Dual Material Screwdriver
#2 x 16" Phillips® Dual Material Screwdriver
3/8" x 16" Slotted Dual Material Screwdriver

Drivers

Ratcheting Nut Driver Set – 16 Pcs.

Product Information

Catalog No	8916D
Features & Benefits	<ul style="list-style-type: none"> ▪ Contoured, Dual Material Comfort Grip ▪ Oil and Solvent Resistant ▪ Precision, Fine Tooth, Reversible Ratcheting Mechanism ▪ Interchangeable, Color Coded Nutdriver Shafts ▪ Metric/SAE



- 1/4" Drive Ratcheting Stubby Screwdriver Handle
- 3/16" Ratcheting Nutdriver Shaft
- 1/4" Ratcheting Nutdriver Shaft
- 5/16" Ratcheting Nutdriver Shaft
- 11/32" Ratcheting Nutdriver Shaft
- 3/8" Ratcheting Nutdriver Shaft
- 7/16" Ratcheting Nutdriver Shaft
- 6mm Ratcheting Nutdriver Shaft
- 7mm Ratcheting Nutdriver Shaft
- 8mm Ratcheting Nutdriver Shaft
- 9mm Ratcheting Nutdriver Shaft
- 10mm Ratcheting Nutdriver Shaft
- 11mm Ratcheting Nutdriver Shaft
- 12mm Ratcheting Nutdriver Shaft

Pliers



Pliers

Compound Action // **PIVOTFORCE** Pliers

Product Information

Features & Benefits	<ul style="list-style-type: none"> ▪ Professional Easy-Clean Dipped Grips ▪ Meets or Exceeds Applicable ASME Performance Requirements ▪ Designed with Standard Bevel Edges for General Wire Cutting ▪ Forged Steel for Superior Strength and Durability ▪ Anti-Rust Coating ▪ Unique Compound Action Requires 40% Less Effort To Cut ▪ Induction Hardened Cutting Edge for Long Life
--------------------------------	---

Art. No	Description
82124	2 Pc. PivotForce™ Compound Action Plier Set
82121	8" PivotForce™ Long Nose Cutting Plier
82120	8" PivotForce™ Diagonal Cutting Plier

• Clear Anti-Rust Coating

Performance

- Unique Compound Action Design requires 40% less effort to cut, so it is easier and quicker to make cuts
- Machined, Cross Checked Jaw pattern for gripping and twisting in any direction (Long Nose only)
- Easy-Clean Dipped Handle grips

Strength

- Induction Hardened Cutting Edge for long life
- Meets or Exceeds Applicable ASME performance requirements
- Forged Steel for superior strength and durability

Access

- Long Nose Design allows access in confined spaces

RECOMMENDED
MAX CUT CAPACITY

12 AWG

Long Nose and Diagonal Cutting Pliers

82120 **82121** **82124**

Pliers

Compound Action // Double-X® Pliers

Product Information

- | Features & Benefits | |
|---------------------|---|
| | <ul style="list-style-type: none"> Maximum Reach Without Exceeding Center Point of Interference Jaws Open Greater Distance Than the Handle for Added Reach in Tight Locations Compound Joint Allows Access with Minimal Handle Movement Flush Rivet for Strength and Narrow Profile |

Art. No	Description
---------	-------------

82018	1/2 Diameter Hose Grip Double-X® Pliers
82106	2 Pc. Double-X® Pliers Set (Straight and 45 Degree)
82107	3 Pc. Double-X® Hose Grip Pl. Set (5/16", 3/4", 1/2")
82005D	Straight Double-X® Plier
82006D	45 Degree Double-X® Pliers

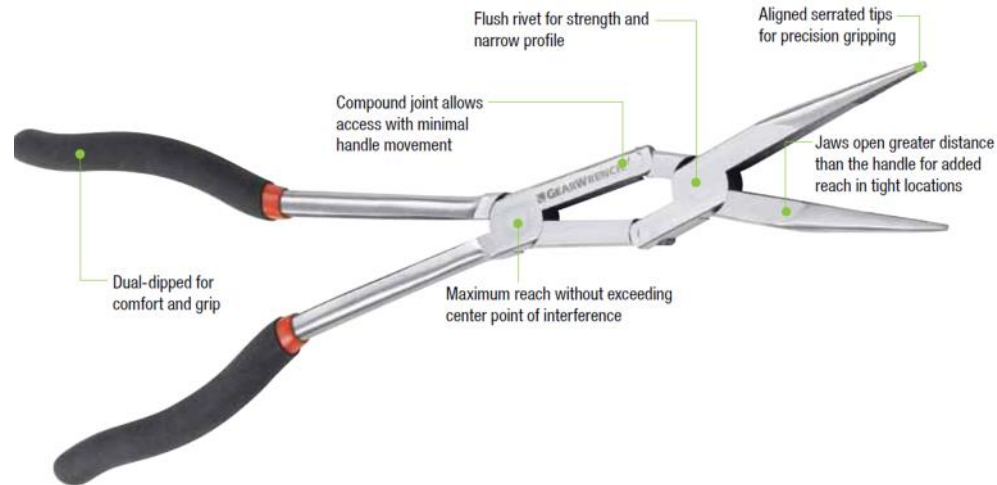

82006D



82005D



82018

Pliers

Mixed Standard Plier Set // Dual Material

Product Information

Catalog No	82108
Features & Benefits	<ul style="list-style-type: none"> ▪ Forged From Premium Alloy Steel ▪ Precision Machined for Exact Tolerances and Fit ▪ Slim Handle and Head Design ▪ Curved Back Handles for Added Leverage and Less Slip ▪ Exclusive Rounded Inside Edges for Comfort ▪ "Finger Tipping" End Texture Grips for Access

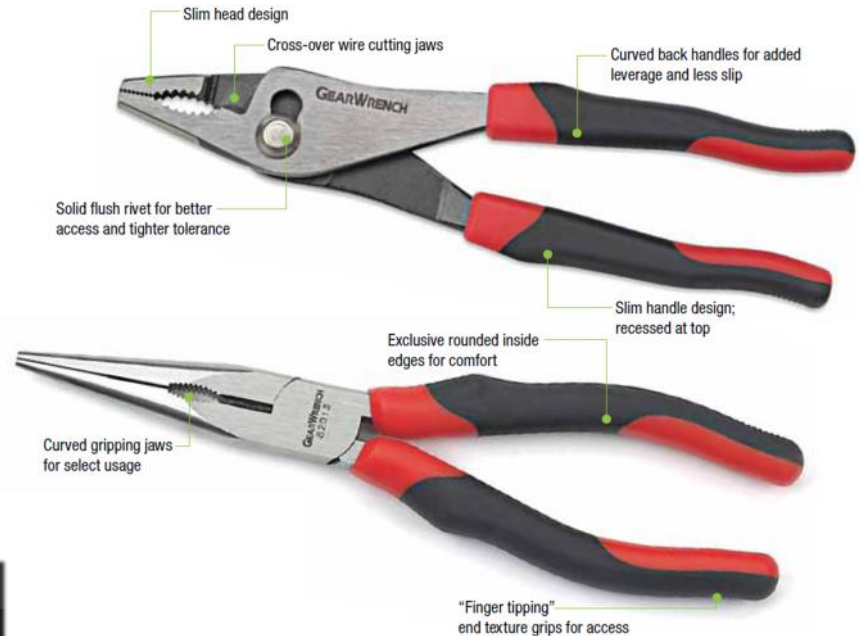

- 9-1/2" Dual Material Tongue and Groove Pliers
- 7" Dual Material Diagonal Cutting Pliers
- 8" Dual Material Long Nose Pliers
- 8" Dual Material Slip Joint Pliers
- 8" Dual Material Lineman's Pliers
- 8" Dual Material End Cutting Nipper Pliers
- 12" Dual Material Straight Jaw Groove Joint Pliers

Pliers

Mixed Standard Plier Set // Dipped Handle

Product Information

- | | |
|---------------------------------------|--|
| <p>Features & Benefits</p> | <ul style="list-style-type: none"> ▪ Unique Forged Alloy Tool Steel for Strength and Durability ▪ Clear Anti-Rust Coating ▪ Professional Easy-Clean Dipped Grips ▪ Meets or Exceeds Applicable ASME Requirements ▪ Laser-Hardened Cutting Edge for Longer Life on Cutting pliers ▪ Induction Hardened, Angled Teeth for Increased Grip on Tongue and Groove Pliers |
|---------------------------------------|--|

Art. No	Description
---------	-------------

82114	4Pc Plier Set
82116	7 Pc. Mixed Pliers Set

- 10" Straight Jaw Tongue and Groove Pliers
- 8" Slip Joint Pliers
- 7" Heavy-Duty Diagonal Cutting Pliers
- 7-1/2" Long Nose Side Cutting Pliers

- 10" Straight Jaw Tongue and Groove Pliers
- 12" Straight Jaw Tongue and Groove Pliers
- 8" Slip Joint Pliers
- 8" Lineman's Side Cutting Pliers
- 7" Heavy-Duty Diagonal Cutting Pliers
- 7-1/2" Long Nose Side Cutting Pliers



Pliers

Push Button Tongue and Groove Pliers

Product Information

- | | |
|---------------------------------------|---|
| <p>Features & Benefits</p> | <ul style="list-style-type: none"> ▪ Push Button for Quick and Easy Size Adjustment ▪ Double the Number of Jaw Positions Compared to Standard Tongue & Groove Pliers for Increased Flexibility and Gripping Comfort ▪ Induction Hardened V-Jaws with Angled Teeth for Gripping Flat, Curved, Square or Hexagonal Objects ▪ Long Jaws with Thin Head Design for Working in Tight Spaces ▪ Forged Chrome-Vanadium Steel for Strength and Durability ▪ Clear Anti-Rust Coating ▪ Professional Easy-Clean Dipped Grips ▪ Meets or Exceeds ASME Performance Requirements |
|---------------------------------------|---|

Art. No	Description
82118	3-pc Push Button T & G Plier Set 8", 10", 12"
82158	8" Push Button T&G Pliers
82160	10" Push Button T&G Pliers
82162	12" Push Button T&G Pliers

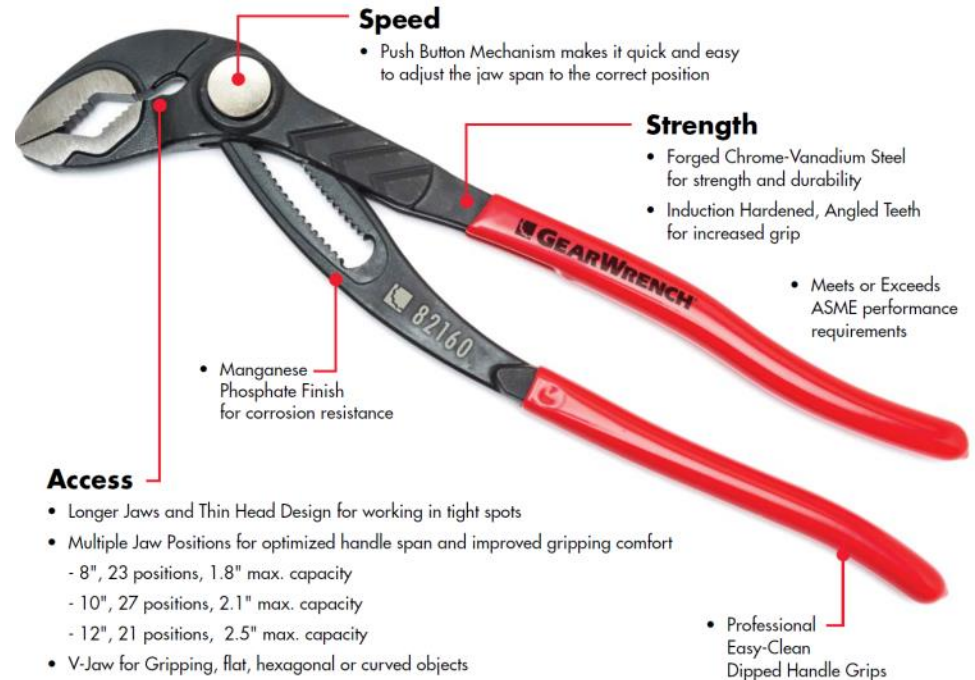

Pliers

Snap Ring Pliers

Product Information

- | | |
|---------------------|--|
| Features & Benefits | <ul style="list-style-type: none"> ▪ Remove and Install Snap Rings ▪ Fixed Tips for Everyday Prof. Use ▪ Forged Design for Strength & Durability ▪ Tapered Jaw Design Allows Increased Reach and Access ▪ Tapered Tip Design for Improved Snap Ring Retention ▪ Professional Easy-Clean Dipped Grips |
|---------------------|--|

Art. No	Description
---------	-------------

82130	5" External Straight Snap Ring Pliers
82131	5" External 90° Snap Ring Pliers
82133	5" Internal Straight Snap Ring Pliers
82134	5" Internal 90° Snap Ring Pliers
82136	7" External Straight Snap Ring Pliers
82137	7" External 90° Snap Ring Pliers
82139	7" Internal Straight Snap Ring Pliers
82140	7" Internal 90° Snap Ring Pliers
82142	9" External Straight Snap Ring Pliers
82143	9" External 90° Snap Ring Pliers
82145	9" Internal Straight Snap Ring Pliers
82146	9" Internal 90° Snap Ring Pliers
82150	4-Pc 7" External & Internal Snap Ring Plier Set

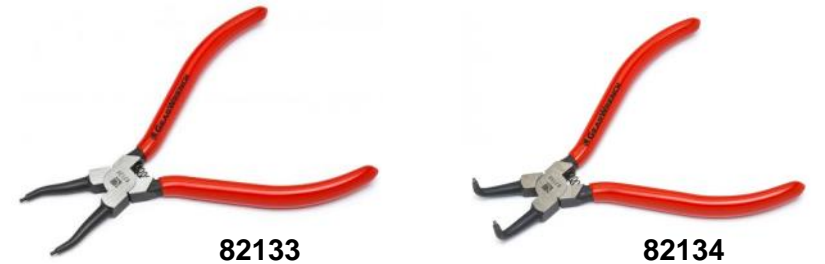

Pliers

Retaining Ring Pliers

Product Information

- | | |
|---------------------|---|
| Features & Benefits | <ul style="list-style-type: none"> ▪ Pliers Includes: 5 Pairs of Color Coded Tips & Hex Wrench ▪ Hex Shaped Locking Guides Firmly Hold Tips ▪ Ergonomic Anti-Slip Sealed Air Pocket Grips for Comfort ▪ Spring Loaded for Faster Work ▪ For Up to 1.0" Diameter Rings for small, and 2.0" Diameter Rings for large ▪ Easily Convert From Internal to External Rings By Moving Levers. No Pins to Push |
|---------------------|---|



3150D



315177

Art. No	Description
3150D	Universal Convertible Retaining Ring Pliers, Small
3151	Universal Convertible Retaining Ring Pliers, Large
315077	Small Tip Set: .024" Straight; .038" Straight; .038" 90 Degree; .047" Straight; .047" 90 Degree; 2 mm Hex
315177	Large Tip Set: .024" Straight; .038" Straight; .038" 90 Degree; .047" Straight; .047" 90 Degree; 2 mm Hex

Pliers

Hose Clamp Pliers

Product Information

Features & Benefits

Straight Hose Clamp Pliers

- Dual Dipped for Additional Comfort
- For Use on Hose Clamps - Flat Band
- Easy to Use Locking Feature

Corbin Style Hose Clamp Pliers

- Easy to Use Locking Feature
- Dual Dipped for Additional Comfort
- For Corbin Style Hose Clamps
- Plier Tips Trap and Hold Clamp, and Swivel for Multiple Angle Access

Art. No Description

3975D Corbin Style Hose Clamp Pliers

3976D Straight Hose Clamp Pliers

GearWrench offers an ever growing variety of automotive specialized application tools designed to last and make the professionals job easier



3975D



3976D

Striking

Hammer and Mallet Set – 5 Pcs

Product Information

Catalog No	82303D
Features & Benefits	<ul style="list-style-type: none">▪ Popular starter set of Hammers and mallets▪ Soft face, Rubber Mallet, Drilling Hammer and Ball Pein▪ Precision Hardened Striking Face▪ Durable Storage Tray▪ Fiberglass Handle▪ Molded Comfort Grip Handle



16 oz. Ball Pein Hammer with Fiberglass Handle

3 lb. Drilling Hammer with Fiberglass Handle

16 oz Dead Blow Hammer - Composite Handle

16 oz. Rubber Mallet with Hickory Handle

12 oz. Soft Face Hammer with Black Cushion Grip Handle

Struck

Punch and Chisel Sets

Product Information

- | | |
|---------------------|--|
| Features & Benefits | <ul style="list-style-type: none"> Center Punch for Marking Center Lines and Pilot Drill Locations Long Taper Punch to Install and Remove Pins and Shafts and to Align Holes Starter Punch for Both Starting and Installing Pins and Rivets Chisel for Cutting Rivets, Bolts, and Nuts Pin Punch for Final Removal to Drive Out Pins and Rivets |
|---------------------|--|

Art. No	Description
---------	-------------

82305	12 Pc. Punch and Chisel Set
82306	27 Pc. Punch and Chisel Set



82305

1/4" x 4-3/4" Cold Chisel	1/8" x 5" Pin Punch
3/8" x 5" Cold Chisel	5/32" x 5-1/4" Pin Punch
1/2" x 6" Cold Chisel	3/16" x 5-1/2" Pin Punch
5/8" x 6-1/2" Cold Chisel	1/8" x 8" Long Taper Punch
5/32" x 5" Center Punch	3/16" x 5" Starter Punch
3/32" x 4-3/4" Pin Punch	1/8" x 4-1/2" Starter Punch



82306

1/4" x 4-3/4" Cold Chisel	5/32" x 5-1/4" Pin Punch
3/8" x 5" Cold Chisel	3/16" x 5-1/2" Pin Punch
7/16" x 5-1/2" Cold Chisel	1/4" x 7" Pin Punch
1/2" x 6" Cold Chisel	5/16" x 7" Pin Punch
5/8" x 6-1/2" Cold Chisel	1/8" x 8" Long Taper Punch
3/4" x 7" Cold Chisel	5/32" x 8-1/2" Long Taper Punch
7/8" x 7-1/2" Cold Chisel	3/16" x 9" Long Taper Punch
1" x 8" Cold Chisel	1/4" x 11" Long Taper Punch
15/16" x 4-1/4" Center Punch	5/32" x 5" Starter Punch
5/32" x 5" Center Punch	3/16" x 5" Starter Punch
1/4" x 5-1/2" Center Punch	1/4" x 6" Starter Punch
3/32" x 4-3/4" Pin Punch	1/8" x 4-1/2" Starter Punch
1/8" x 5" Pin Punch	5/16" x 7" Starter Punch
	3/8" x 8" Starter Punch

Pry Bars



Pry Bars

Indexing Pry Bars

Product Information

- | | |
|---------------------|---|
| Features & Benefits | <ul style="list-style-type: none"> 14 Locking Head Positions for Unmatched Access Grooved Head Profile Provides Additional Traction Head Indexible Through 180° for Greater Leverage For Demolition, Repositioning Equipment, Aligning Steel Components, Engine Repositioning, and Other Heavy-Duty Applications Extendable Handle Gives Greater Access and Leverage, and Collapses So It Can Be Stored Easily |
|---------------------|---|

Art. No	Description
82208	8" Indexing Pry Bar
82210	10" Indexing Pry Bar
82216	16" Indexing Pry Bar
82220	29" Extendable Indexing Pry Bar
82224	24" Indexing Pry Bar
82233	33" Indexing Pry Bar
82248	48" Extendable Indexing Pry Bar
82300	2 Pc. Indexing Pry Bar Set (8" & 16")
82301D	3 Pc. Indexing Pry Bar Set (8", 10" & 16")



Pry Bars

Pry Bars with Angled Tip

Product Information

Features & Benefits	<ul style="list-style-type: none"> ▪ For Leverage in Medium-Duty Automotive and Industrial Applications ▪ Angled Tip for Increased Leverage and Access ▪ Comfortable Ergonomic Handle
--------------------------------	--

Art. No	Description
---------	-------------

82403	3-pc Set 12", 17", 25" w/ angled tips
82408	8" x 1/4" Pry Bar w/ angled tip
82412	12" x 3/8" Pry Bar w/ angled tip
82417	17" x 3/8" Pry Bar w/ angled tip
82425	25" x 1/2" Pry Bar w/ angled tip
82431	31" x 1/2" Pry Bar w/ angled tip
82436	36" x 1/2" Pry Bar w/ angled tip



Forming and Shaping



Forming and Shaping

File Set – 4 Pcs

Product Information

Catalog No	82820
Features & Benefits	<ul style="list-style-type: none">▪ Set Comprised of the 4 Most Common File Shapes▪ Ergonomic Dual Material Handle

8" Flat Bastard File

8" Round Bastard File

8" Half Round Bastard File

8" Triangle Bastard File



Forming and Shaping

Tap and Die Sets

Product Information

- | | |
|--------------------------------|---|
| Features & Benefits | <ul style="list-style-type: none"> ▪ For Leverage in Medium-Duty ▪ Die Adapter Works on Round and Hex Shaped Dies ▪ 5 Degree Ratcheting Arc with Reversible Lever Eliminates Hand Over Hand Turning ▪ Patented Twist Lock Guide System Reduces "Back Walk" of Die Guard ▪ Die Adapter Works with Pass-Thru® Ratchet and Socket System as Well as Vortex™ Socket Accessories ▪ Auto-locking Feature Allows for Safe Removal of Tap Adapter ▪ Spring-Loaded Cap Allows for Quick-Release of Large Tap Adapter ▪ Extension Adapters Provide Access in Tight Confined Areas |
|--------------------------------|---|

Art. No	Description
---------	-------------

3880	Ratcheting Tap and Die Drive Tool Set
3885	Ratcheting Tap and Die Drive Tool Set SAE
3886	Ratcheting Tap and Die Drive Tool Set Metric
3887	Ratcheting Tap and Die Drive Tool Set SAE/Metri
82812	Ratcheting Tap and Die Drive Tool Set SAE/Metri

Access

- Extend the length of the tap and die system by combining adapters and any standard 3/8" drive extension



Design

- Works with either round or hex style dies
- Auto-locking feature allows for safe removal of tap adapter
- Die adapter works with GearWrench Pass-Thru® Ratchet and Socket System

- Supported by full line of replacement taps and dies



3880

3886

32812

Forming and Shaping

Extended Long Reach Scraper

Product Information

Catalog No	3528D
Features & Benefits	<ul style="list-style-type: none">▪ Replacement Plastic Blade Available▪ 7" Long Reach Scraper is Ideal for Use Where Added Extension is Needed, Such As Deep Recessed Dash Boards in Mini-Vans▪ Contains Two Replacement Blades, Including One Plastic Blade Which Will Not Harm Coated Windows



Forming and Shaping

Screw Extractor Kits

Product Information

- | | |
|---------------------|--|
| Features & Benefits | <ul style="list-style-type: none"> ▪ Tap Lightly with a Hammer and Turn Counterclockwise with a Tap Wrench to Remove the Screw ▪ Features Undercut Flutes for More Positive Grip ▪ Spiral Blades Grip Screw ▪ Removes Broken Studs, Set Screws, Pipe and Alemite Fittings ▪ Drill a Hole in the Screw and Place Extractor into Hole |
|---------------------|--|

Art. No	Description
---------	-------------

2419D	Spiral Screw Extractor Kit
720DD	Screw Extractor Kit



2419D



720DD

Mechanical Hand Tools



Mechanical Hand Tools

Impact Socket Sets

Product Information

- | | |
|---------------------|--|
| Features & Benefits | <ul style="list-style-type: none"> ▪ Full range and coverage from ¼ drive to ¾ drive all packed in easy to use all complete range sets ▪ Chrome Molybdenum Alloy steel for added strength and long life ▪ Laser engraved on both sides and hard stamped for easy size visibility ▪ Master sets come in durable steel hinged and buckled sets for long lasting storage ▪ Manganese Phosphate coatings provide added corrosion protection, ▪ Also open stock sockets are available |
|---------------------|--|



Art. No	Description
84911N	12 Pc. Impact Socket Set Metric 3/8" Drive
84914N	13 Pc. 3/8"DR Metric DEEP
84918N	15Pc. 3/8"DR Metric Universal
84930N	12Pc. 1/2" Drive 6 Point Metric Impact Socket Set
84933N	25Pc. 1/2" Drive 6 Point Metric Impact Socket Set
84935N	29Pc. 1/2" Drive 6 Point Mt. Deep Impact Socket Set
84939N	15Pc. 1/2"DR Metric Universal Impact Socket Set
84945N	10Pc. 1/2"DR MM Deep Universal
84948N	39Pc. 1/2" STD & DEEP IMPACT SOCKET SET
84925N	29Pc. 3/8" STD & DEEP IMPACT SOCKET SET

Mechanical Hand Tools

PINLESS Universal Impact Socket Sets

Product Information

- | | |
|---------------------|--|
| Features & Benefits | <ul style="list-style-type: none"> ▪ Pinless 4-Lug Design for Increased Strength Resulting in Extended Life ▪ True 360 Degree Movement Extends Traditional Range of Motion Resulting in a Maximum 30 Degree Operating Angle for Increased Access Socket Wall Dimensions Are Optimized to Provide Strength While Retaining Access to Restricted Fasteners ▪ Manufactured From Chrome Molybdenum Alloy Steel (Cr-Mo) for Exceptional Strength and Durability ▪ Off-Corner Loading Design Reduces Fastener Rounding ▪ Hard Stamped Size Markings for Long Identification Life ▪ Meets or Exceeds ASME B107.110-2012 |
|---------------------|--|



Art. No	Description
84974	SET SKT P/LESS UNIV IMP 3/8DR 6PT 7PCSAE
84975	SET SKT P/LESS UNIV IMP 3/8DR 6PT 11PC M
84976	SET SKT P/LESS UNIV IMP 3/8DR 6PT 3PC MM
84978	SETSKT PIN/LES UNIV IMP 1/2DR 6PT 9PCSAE
84979	SETSKT PIN/LES UNIV IMP 1/2DR 6PT 10PCMM

Mechanical Hand Tools

PINLESS Impact Universal Joints

Product Information

- | | |
|---------------------|---|
| Features & Benefits | <ul style="list-style-type: none"> • X-Core Ball Design Delivers Improved Durability Versus Pinned Product (Over 4X) • 30 Degree Flex Angle • Smooth 360 Degree Rotation • Ball Detent Socket Retention • Corrosion Resistant Black Oxide Finish • Made from Impact Grade Chrome Molybdenum for Strength and Durability |
|---------------------|---|



Art. No	Description
84180	P/LESS UNIV JOINT IMP 1/4DR
84440	P/LESS UNIV JOINT IMP 3/8DR
84715	P/LESS UNIV JOINT IMP 1/2DR
84960	SET P/LESS UNIV JOINT IMP

Mechanical Hand Tools

PINLESS Impact Extensions

Product Information

- | Product Information | |
|---------------------|--|
| Features & Benefits | <ul style="list-style-type: none">• X-Core Pinless Universal Design for Strength & Durability• Universal Extensions Can Be Used with Any Socket Style, Available Lengths 6", 9", 12"• 6 Point Sockets from 8mm to 15mm, Overall Length 9" for access• 30 Degree Flex Angle• Smooth 360 Degree Rotation• Black Oxide Finish for Corrosion Resistance• Meets or Exceeds ASME requirements• Hard Stamped Size Markings |
-

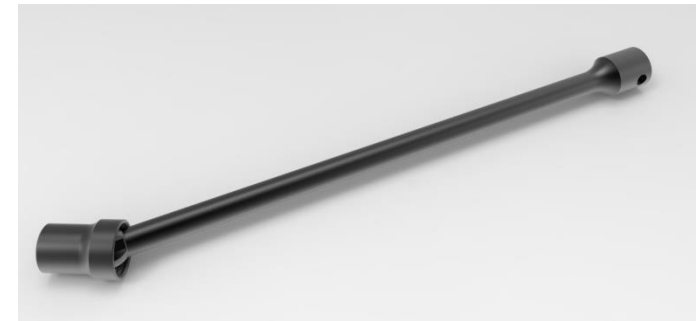

Mechanical Hand Tools

Non-Ratcheting Wrenches

Product Information

Features & Benefits	<ul style="list-style-type: none"> ▪ Bright, Full Polish Chrome Finish ▪ Offset Box End for Increased Access ▪ Off-Corner Loading Design on Open End: Stronger Grip, Reduces Fastener Rounding, Up to 25% More Torque
---------------------	--

Art. No	Description
---------	-------------

81902	15-Pc. Long Pattern Combination Non-Ratcheting Wrench Set Metric
81904	10-Pc. Stubby Combination Non-Ratcheting Wrench Set Metric
81916	22-Pc. Long Pattern Combination Non-Ratcheting Wrench Set Metric
81919	44-Pc. Long Pattern Non-Ratcheting Combination Wrench Set SAE/Metric
81920	18-Pc. Long Pattern Combination Non-Ratcheting Wrench Set Metric
81924	14-Pc. Full Polish Combination Non-Ratcheting Wrench Set SAE
81925	14-Pc. Full Polish Combination Non-Ratcheting Wrench Set Metric



81902



81904

Mechanical Hand Tools

Ratcheting Wrenches

Product Information

Features & Benefits

- Ratcheting Box End needs as little as 5° to Move Fasteners vs. 30° for Standard Wrenches
- Bright, Full Polish Chrome Finish
- The Original Patented Ratcheting Wrench
- Surface Drive® on Box End Provides Off-Corner Loading for Better Grip and Reduced Fastener Rounding
- Open Stock are also available as well as set
- Broadest offering with over 20 configurations for demanding applications with coverage in over 375 sizes
- Boxed in different style trays



XL COMBINATION RATCHETING WRENCH



OPEN END RATCHETING WRENCH



XL LOCKING FLEX RATCHETING WRENCH



XL SPLINE RATCHETING WRENCH



XL GEARBOX™ RATCHETING WRENCH



REVERSIBLE RATCHETING WRENCH



FLEX RATCHETING WRENCH



STUBBY FLEX RATCHETING WRENCH



COMBINATION RATCHETING WRENCH



STUBBY RATCHETING WRENCH



QUADBOX™ RATCHETING WRENCH



DOUBLE BOX RATCHETING WRENCH



HALF MOON RATCHETING WRENCH



S-SHAPE RATCHETING WRENCH



E-TORX® RATCHETING WRENCH



INDEXING RATCHETING WRENCH

Mechanical Hand Tools

XL Flex-Head GearBox™ Ratcheting Wrench

Product Information

Features & Benefits	<ul style="list-style-type: none"> ▪ Handle Collapses to allow access in tight areas including manholes, trenches, vaults, transformers, and other areas ▪ Start tough cuts with both hands close together for better body positioning and increasing leverage during cuts in utility buckets and other tight areas ▪ Robust and strong pivot mechanism ▪ Induction hardened cutting edges
---------------------	--

Art. No	Description
86021	21mm 12 Point Metric XL Flex Head GearBox™
86022	22mm 12 Point Metric XL Flex Head GearBox™
86024	24mm 12 Point Metric XL Flex Head GearBox™

ACCESS

- 72 Teeth Give a 5° swing arc for turning fasteners in tight spaces
- Ratcheting Flex-Head Box-End gives adjustable access angle

ACCESS

Extra Long Beam Length

For improved access



ACCESS

- **Non-Ratcheting End** for breaking loose fasteners
- **0 Degree Offset Box End** with Slim Profile for access to recessed fasteners
- 12 point with Surface Drive for reduced fastener rounding

- **Bright, Full Polish Chrome** for easy cleaning
- **Highly Visible, Stamped Size Markings** for easy size recognition

Mechanical Hand Tools

Standard and Deep Chrome Sockets

Product Information

Features & Benefits	
	<ul style="list-style-type: none"> ▪ Off-Corner Loading Design Reduces Fastener Rounding ▪ Chamfered Opening to Guide Fastener Into Socket ▪ Large Hard-Stamped Size Identification ▪ Double Line (SAE) and Knurled (Metric) Ring to Easily Identify Standard vs. Metric Sockets ▪ Full Polish Chrome Finish Cleans Easily and Resists Corrosion ▪ 6 and 12 Point models are available ▪ Metric and SAE are available ▪ Deep and Standard models are available ▪ Open stock are also available as well as sets

Speed

- Angled entry guides the socket onto the fastener
- Full polish for easy cleaning and visibility
- Double line (SAE) and knurled line (Metric) to easily identify standard versus metric sockets
- Large hand-stamped size on both sides for fast, easy identification



Strength

- Surface Drive® contact points virtually eliminate the rounding of fasteners



- Sets come on the GearWrench rail system



DEEP STANDARD

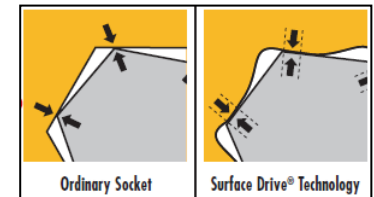

Mechanical Hand Tools

Chrome Bit Socket Sets

Product Information

Features & Benefits	<ul style="list-style-type: none"> Different types of bit socket sets including Hex Bit, Long Ball Hex Bit, Triple Square Bit, Torx Bit, Stubby Hex Bit etc.
---------------------	---

Art. No	Description
---------	-------------

80281	8-Pc 1/4" & 3/8" Dr. Metric Stubby Hex Bit Socket Set
80291	8-Pc 1/4" & 3/8" Dr. SAE Stubby Hex Bit Socket Set
80573	8 Pc. Metric Long Ball Hex Bit Socket Set
80720	7 Pc. Metric Hex Bit Socket Set
80726	36 Pc. Master TORX® Set with Hex Bit Sockets
80744	6-Pc 3/8" & 1/2" Dr. Tri. Square Stubby Bit Socket Set
80874	5-Pc 3/8" & 1/2" Dr. Long Triple Square Bit Socket Set
80898	13-Pc 1/4", 3/8", 1/2" Dr. Stubby Torx® Bit Socket Set
80985	9-Pc 3/8" Drive Universal E-Torx Bit Socket Set
80994	5-Pc 1/4" Drive Universal Stubby Torx® Bit Socket Set
81052	11-Pc 1/4" & 3/8" Dr. Uni. Stubby Tamper Torx®
81070	8-Pc 1/4", 3/8" & 1/2" Drive Universal Stubby Triple
81088	7-Pc 1/4" & 3/8" Drive Universal Metric Stubby Hex
81100	9-Pc 1/4" & 3/8" Drive Stubby Triple Square Bit
81149	9-Pc 1/4" Drive SAE Stubby Hex Bit Driver Set
81160	9-Pc 1/4" Drive Metric Stubby Hex Bit Set
81180	10-Pc 1/4" Drive Phillips and Slotted Bit Driver Set
81196	10-Pc 1/4" & 3/8" Drive Stubby Torx Bit Driver Set



80281



80573



80726



80744



81100



81052



81180

Mechanical Hand Tools

84 Tooth Ratchets

Product Information

Features & Benefits	<ul style="list-style-type: none"> ▪ Bright Chrome Finish ▪ Teardrop Shaped Head ▪ Meets or Exceeds ASME B1007.10
---------------------	--

Art. No	Description
81007F	1/4" Drive Cushion Grip 84 Tooth Ratchet
81011F	1/4" Drive Full Polish Teardrop 84 Tooth Ratchet
81012F	1/4" Drive Full Polish Flex Head 84 Tooth Ratchet
81211F	3/8" Drive Full Polish Teardrop 84 Tooth Ratchet
81215F	3/8" Drive Full Polish Flex Head 84 Tooth Ratchet
81304F	1/2" Drive Full Polish Teardrop 84 Tooth Ratchet
81306F	1/2" Drive Full Polish Flex Head 84 Tooth Ratchet
81268	2Pc 1/4" & 3/8" Long Handle 84 tooth Ratchet
81206F	3 Pc. Full Polish 84 Tooth Ratchet Set
81207F	3 Pc. Cushion Grip 84 Tooth Ratchet Set
81216F	2 Pc. Full Polish Flex Handle 84 Tooth Ratchet Set
81230F	4 Pc. Full Polish Flex Handle 84 Tooth Ratchet Set
81015	1/4"Dr. Locking Flex Ratchet Full Polish 7"
81016	1/4"Dr. Locking Flex Ratchet Cushion Grip 8-1/4"
81266	3/8"Dr. Locking Flex Ratchet Full Polish 11-1/2"
81267	3/8"Dr. Locking Flex Ratchet Cushion Grip 13-1/2"
81362	1/2"Dr. Locking Flex Ratchet Full Polish 17"
81363	1/2"Dr. Locking Flex Ratchet Full Polish 24"



Mechanical Hand Tools

120XP Ratchets

Product Information

- | | |
|---------------------|---|
| Features & Benefits | <ul style="list-style-type: none"> ▪ 120XP Ratchet Head with double-stacked pawl design delivers 120 positions with 3° swing arc ▪ Strength meets or exceeds ASME specifications ▪ Double-stacked pawls engage a 60-tooth gear providing exceptional strength, exceeding industry specifications ▪ Ratchet only needs 3° to move fastener providing increased accessibility ▪ Teardrop low profile head and flush mounted on/off switch allows better access in tight ▪ Full polish chrome handle |
|---------------------|---|

Art. No	Description
---------	-------------

81011P	1/4" Drive 120XP™ Full Polish Teardrop Ratchet
81211P	3/8" Drive 120XP™ Full Polish Teardrop Ratchet
81304P	1/2" Drive 120XP™ Full Polish Teardrop Ratchet
81306P	1/2" Drive 120XP™ Full Polish Teardrop Flex Head
81206P	3 Pc. 1/4", 3/8" & 1/2" Drive 120XP™ Full Polish Set
81230P	4 Pc. 1/4", 3/8", 1/2" Drive 120XP™ Flex Head Set



- 120 Positions give a 3° ratchet arc so you can turn a fastener in tighter confines
- Highly visible on/off markings on the head



- Ratchet only needs 3° to move fastener providing increased accessibility
- Teardrop low profile head and flush mounted on/off switch allows better access in tight spaces

- Double-stacked pawls engage a 60-tooth gear providing exceptional strength, exceeding industry specifications
- Enclosed head design for extreme resistance to dirt

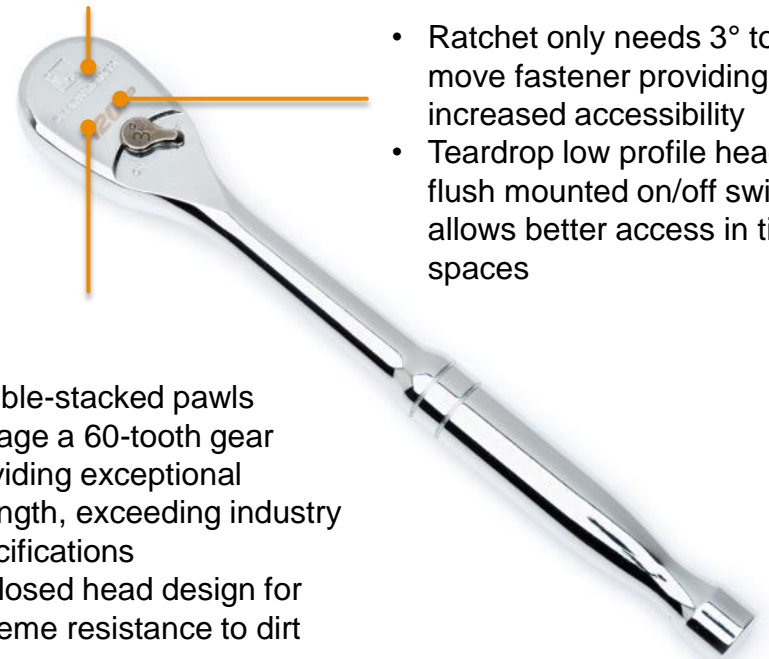

Mechanical Hand Tools

120XP Extra Long Handle Ratchets

Product Information

Features & Benefits	<ul style="list-style-type: none"> ▪ Extra long handle for additional access, 9" on 1/4" Dr. , 18" on 3/8" Dr. , 24" on 1/2" Dr. ▪ 120XP Ratchet Head with double-stacked pawl design delivers 120 positions with 3° swing arc ▪ Strength meets or exceeds ASME specifications ▪ Teardrop low profile head and flush mounted on/off switch allow better access in tight spaces ▪ Enclosed head design for extreme resistance to dirt infiltration ▪ Highly visible on/off markings on the head ▪ Full polish chrome handle
---------------------	---

Art. No	Description
81034	1/4"Dr. 120XP Extra Long Ratchet, 9" Handle
81269	3/8" Dr. 120XP Extra Long Ratchet, 18" Handle
81364	1/2" Dr. 120XP Extra Long Ratchet, 24" Handle
81271	2 Pc.Extra Long Ratchet Set (1/4" Dr. & 3/8" Dr.)

- 120 Positions give a 3° ratchet arc so you can turn a fastener in tighter

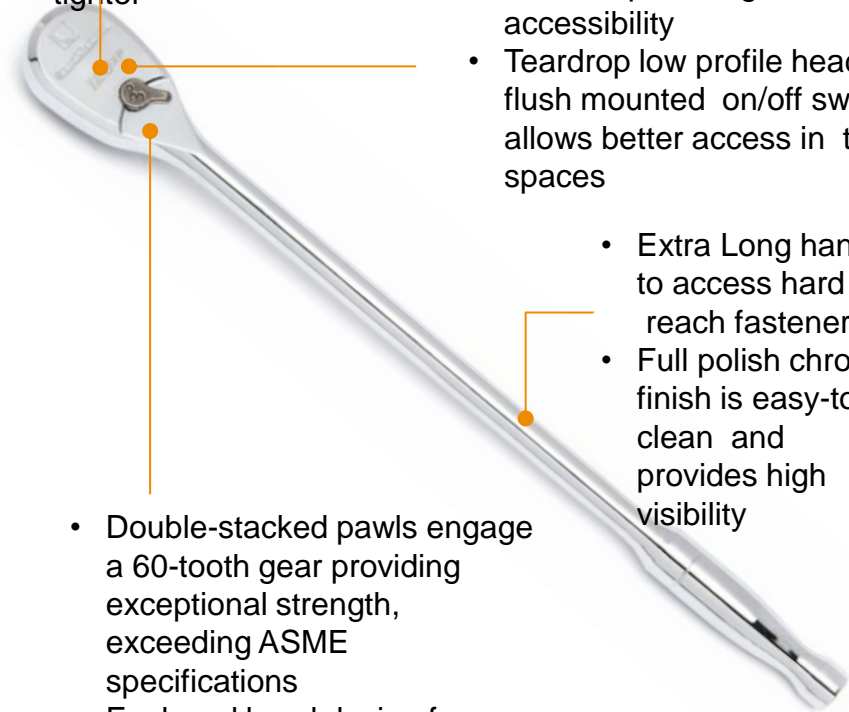

- Ratchet only needs 3° to move fastener providing increased accessibility
- Teardrop low profile head and flush mounted on/off switch allows better access in tight spaces

- Extra Long handle to access hard to reach fasteners
- Full polish chrome finish is easy-to-clean and provides high visibility

- Double-stacked pawls engage a 60-tooth gear providing exceptional strength, exceeding ASME specifications
- Enclosed head design for extreme resistance to dirt

Mechanical Hand Tools

Slim Head Ratchets

Product Information

Features & Benefits	<ul style="list-style-type: none"> ▪ Multi-functional head design converts Bit Driver to Ratchet with insertion of 1/4" Dr. Ratchet adapter. Converts from Ratchet to Bit Driver with removal of 1/4" Dr. Ratchet Adapter. ▪ 9 Position Locking Flex-Head for maximum access ▪ Full Polish Chrome Handle, with 6" and 12" handle lengths ▪ Slim Line Head Design – 0.73" wide, 0.49" thick for excellent access ▪ 1/4" Dr. Ratchet/ Bit Driver Head, Ratchet Adapter meets or exceeds all ASME specifications ▪ Flush mounted forward/reverse lever
---------------------	---

Art. No	Description
81025	1/4" Dr. Slim Head Ratchet, 6" Handle
81030	1/4" Dr. Slim Head Ratchet, 12" Handle
81032	45 Pc. Slim Head Ratchet Set

- Slim Line Head Design – 0.73" wide, 0.49" thick for excellent access
- 72 Teeth give a 5° ratchet arc to turn a fastener in tight confines
- Gear Design Exceeds ASME torque performance requirements
- Flush Mounted Forward/Reverse lever



- 6" and 12" Overall Length for increased access
- Full Polish Chrome
- Ergonomic Handle Design
- Locking Flex Head
- Locked & Unlocked Position

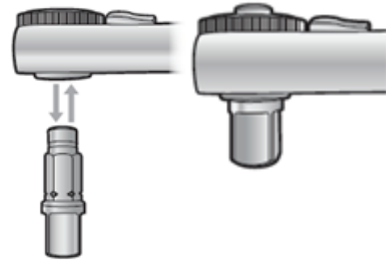

1/4" Drive Bit Ratchet Head

- For 1/4" Hex Screwdriver bits
- Use with 1/4" Drive Adapter to convert to a ratchet

Mechanical Hand Tools

Socket and Ratchet Sets

Product Information

- | | |
|---------------------|---|
| Features & Benefits | <ul style="list-style-type: none"> ▪ Full Polish Chrome Sockets With Large Hard Stamp Size Markings ▪ Includes Storage Case ▪ Knurled Full Polish Chrome Extensions ▪ Sockets Feature Off-Corner Loading Design Reduces Fastener Rounding ▪ Included Thumbwheel Ratchet for Access in Tight Spaces |
|---------------------|---|



80550

Art. No	Description
80326	14 Pc. 1/4" Drive Metric Socket Set
80300	51 Pc. 1/4" Drive 6 Point Socket Set
80301	51 Pc. 1/4" Drive 12 Point Socket Set
80313	26 Pc. 1/4" Dr. 12 Point Standard SAE Skt. Set
80550	57 Pc. 3/8" Drive 6 Point Socket Set
80551	57 Pc. 3/8" Drive 12 Point Socket Set
80707	23 Pc. 1/2" Drive SAE Skt. Set (Standard/Deep)
80708	18 Pc. 1/2" Drive Metric Socket Set
80709	28 Pc. 1/2" Drive Metric Skt Set (Standard/Deep)
80300P	51 Pc. 1/4" Drive 120XP™ SAE/Metric 6 Point St. & Deep Socket Set
80550P	56 Pc. 3/8" Drive 120XP™ SAE/Metric 6 Point St. & Deep Socket Set
80700D	49 Pc. 1/2" Drive 6 Point Socket Set

Mechanical Hand Tools

Socket and Ratchet Sets

Product Information

Features & Benefits

- 3-Drawer Mechanics Hand Tool Sets offer large piece count sets geared towards the professional user requiring tools that get the job done.

Art. No	Description
---------	-------------

80943	168 Pc. Mechanics Hand Tool Set
80944	232 Pc. Mechanics Hand Tool Set
80942	239 Pc. Mechanics Hand Tool Set



	80943 168 Pc. Mechanics Hand Tool Set	80944 232 Pc. Mechanics Hand Tool Set	80942 239 Pc. Mechanics Hand Tool Set
Drive Sizes	1/4, 3/8" Dr.	1/4, 3/8" Dr.	1/4, 3/8, 1/2" Dr.
Wrenches	72 Tooth Ratcheting Combination Wrenches	72 Tooth Ratcheting Combination Wrenches	Non Ratcheting Combination Wrenches
Ratchets	84 Tooth Full Polish Teardrop Ratchets	84 Tooth Full Polish Teardrop Ratchets	45 Tooth Quick Release Full Polish Ratchets
Sockets	Standard & Deep, Hex Bit, Torx® Bit, E-Torx®	Standard & Deep, Hex Bit, Torx® Bit, E-Torx®	Standard & Deep
SAE/Metric	Metric	SAE/Metric	SAE/Metric
Piece Count	168	232	239
Set Image			

Mechanical Hand Tools

Micrometer Torque Wrenches // Metric

Product Information

- | Features & Benefits | |
|---------------------|--|
| | <ul style="list-style-type: none"> ▪ Durable reversible teardrop ratchet head (32-tooth) ▪ Two-directional (L+R) ▪ Audible click and/or impulse when torque setting is reached ▪ ±3% clockwise accuracy between 20% and 100% of range. Complies with ▪ ANSI/ASME B107.14M ▪ International Standard ISO 6789 ▪ Aluminum knurled handle and simplifies use with greasy hands ▪ Matt finished and hardened steel body ▪ Detent style locking collar prevents accidental change of torque setting ▪ Factory calibration supplied with each tool ▪ Packaged in protective blow molded storage case |

Art. No	Description
---------	-------------

85040	1/4 Torque Wrench / 5 – 25 Nm
85042	3/8 Torque Wrench / 10 – 100 Nm
85045	1/2 Torque Wrench / 40 – 200 Nm
85046	1/2 Torque Wrench / 40 – 340 Nm

- Knurled anodized aluminum handle for comfortable grip
- Mid-point on handle clearly marked for accuracy
- Sealed tear drop head provides access and strength and keeps out dirt
- 32-Tooth ratchet mechanism
- Primary scale Nm
- Pull adjustment collar
- Stamped scale on beam & thimble collar for durability and visibility
- Serial number marked on beam (Laser etched)
- Beam + Head is matt finished

Mechanical Hand Tools

Micrometer Torque Wrenches // Imperial

Product Information

Product Information	
Features & Benefits	<ul style="list-style-type: none"> ▪ Durable reversible teardrop ratchet head (32-tooth) ▪ Two-directional (L+R) ▪ Audible click and/or impulse when torque setting is reached ▪ ±3% clockwise accuracy between 20% and 100% of range. Complies with ANSI/ASME B107.14M ▪ International Standard ISO 6789 ▪ Matt finished and hardened steel body ▪ Detent style locking collar prevents accidental change of torque setting ▪ Factory calibration supplied with each tool ▪ Packaged in protective blow molded storage case

Art. No	Description
85061	3/8" Micrometer Torque Wrench 50-250 in/lbs
85062	3/8" Micrometer Torque Wrench 10-100 ft/lbs
85063	1/2" Drive Micrometer Torq. Wrench 20-150 ft/lbs
85066	1/2" Micrometer Torque Wrench 30-250 ft/lbs
85065	3/4" Micrometer Torque Wrench 100-600 ft/lbs
85060	1/4" Micrometer Torque Wrench 30-200 in/lbs

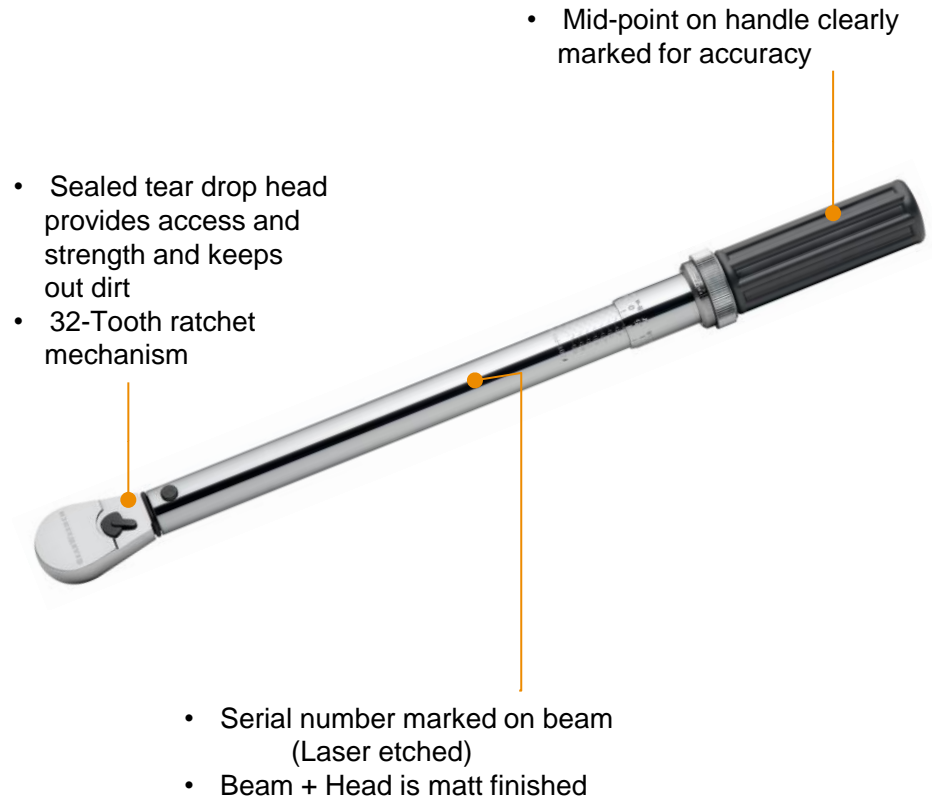

Mechanical Hand Tools

Electronic Torque Wrenches

Product Information

- | | |
|---------------------|---|
| Features & Benefits | <ul style="list-style-type: none"> ▪ Digitally Tracks Torque Measurement. Multiple Alerts When the Target Torque is Reached Prevent Over Torqueing of Bolts. Handle Vibrates, Buzzer Sounds & LED Light Shows Solid ▪ “Target Torque Alert” Gives a Warning as the Target Torque Setting is Approached, So There is Less Chance of Over Torqueing a Bolt ▪ Accurate in Clockwise Direction +/- 2% and +/-3% in a Counter-Clockwise Direction, From 20% to 100% of Full Scale ▪ 5 Torque Measurement Units Available for Working in Nm, Ft-lb, In-lb and Kgf-m, Kgf-cm ▪ 72-Tooth Ratchet Mechanism with a 5 Degree Swing Arc ▪ Requires 2 AA (alkaline) Batteries ▪ Meets or Exceeds ASME B107.28M |
|---------------------|---|

Art. No	Description
---------	-------------

85076	3/8DR WR TRQ ELEC 7.4-99.6 FT LB
85077	1/2DR WR TRQ ELEC 25.1-250.8 FT LB



Mechanical Hand Tools

Gimbal Ratchets

Product Information

- | | |
|--------------------------------|---|
| Features & Benefits | <ul style="list-style-type: none"> ▪ Allows ratchet to rotate on two planes for easier access ▪ 72-tooth ratcheting mechanism for 5° swing arc ▪ Anodized aluminum finish for protection and easy wipe down ▪ The pivoting rings around the ratchet mechanism allow you to angle the head to access fasteners, making it easier to work in areas where it is hard to use a ratchet. |
|--------------------------------|---|

Art. No	Description
---------	-------------

81027	1/4" Drive Gimbal Ratchet
81270	3/8" Drive Gimbal Ratchet

Gimbal design allows ratchet to rotate on two planes for easier access

72-tooth ratcheting mechanism for 5° swing arc

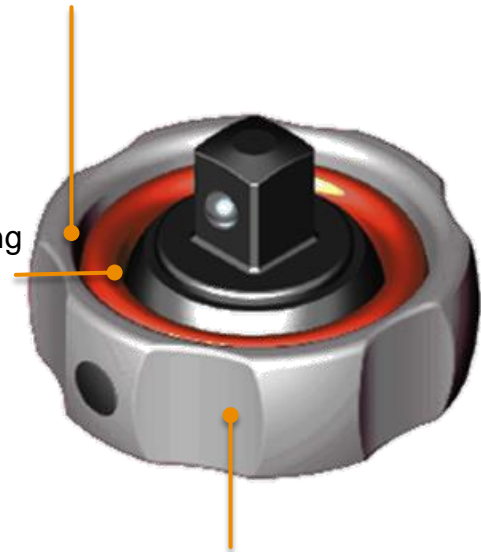

Anodized aluminum finish for protection and easy wipe down

Mechanical Hand Tools

Crowfoot Wrenches

Product Information

Features & Benefits	<ul style="list-style-type: none"> ▪ Size Laser Etched on Both Sides of Head for Easy Identification ▪ Bright Chrome Finish ▪ Quickly Ratchet Nuts and Bolts Without Removing the Wrench From the Fastener ▪ Exceeds ASME Requirements for Torque Performance
---------------------	---

Art. No	Description
---------	-------------

81908	11 Pc.Crowfoot Drive Non-Ratcheting Wrench Set
81909	10 Pc.Crowfoot Drive Non-Ratcheting Wrench Set
89118	11 Pc. SAE Ratcheting Crowfoot Set
89119	10 Pc. Metric Ratcheting Crowfoot Set

- Quickly ratchet nuts and bolts without removing the wrench from the fastener
- Arrow stamped on head quickly identifies direction of rotation
- Use with 3/8" drive extensions to access hard to reach fasteners
- Use when there is not sufficient space to use a ratchet
- Open end wrench allows access to fasteners when there are height restrictions

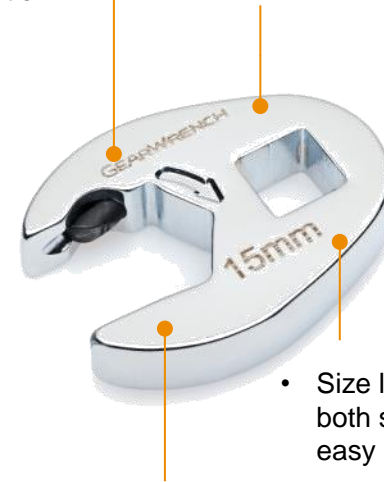

- Size laser engraved on both sides of head for easy identification
- Bright chrome finish is easy-to-clean and provides high visibility

Ratcheting Crowfoot

Mechanical Hand Tools

Standard Flex Flare Nut Wrench

Product Information

- | | |
|---------------------|---|
| Features & Benefits | <ul style="list-style-type: none">▪ Size stamped on both sides for quick identification▪ Flex head provides access to difficult-to-reach hose fittings and gets around other obstructions▪ Flare nut wrench head easily slips over lines▪ Bright chrome finish is easy-to-clean and provides high visibility▪ Open Stock items are also available |
|---------------------|---|

Art. No	Description
---------	-------------

81906	6 Pc. Metric Flare Nut Wrench Set
81911D	6 Pc. Metric Flex Flare Nut Wrench Set
81915	3 Pc. Flex Flare Nut Wrench Set Metric



Mechanical Hand Tools

Ratcheting Flex Flare Nut Wrench

Product Information

Features & Benefits	<ul style="list-style-type: none"> ▪ Quick ratchet flare nuts and bolts without removing the wrench from the fastener ▪ Size stamped on both sides for quick identification ▪ Flex head provides access to difficult-to-reach hose fittings and gets around other obstructions ▪ Flare nut wrench head easily slips over lines ▪ Bright chrome finish is easy-to-clean and provides high visibility
---------------------	--

Art. No	Description
89100	5 Pc. SAE Ratcheting Flex Flare Nut Wrench Set
89101D	6 Pc. Metric Ratcheting Flex Flare Nut Wrench Set

- Flex head provides access to difficult-to-reach hose fittings and gets around other obstructions
- Flare nut wrench head easily slips over lines

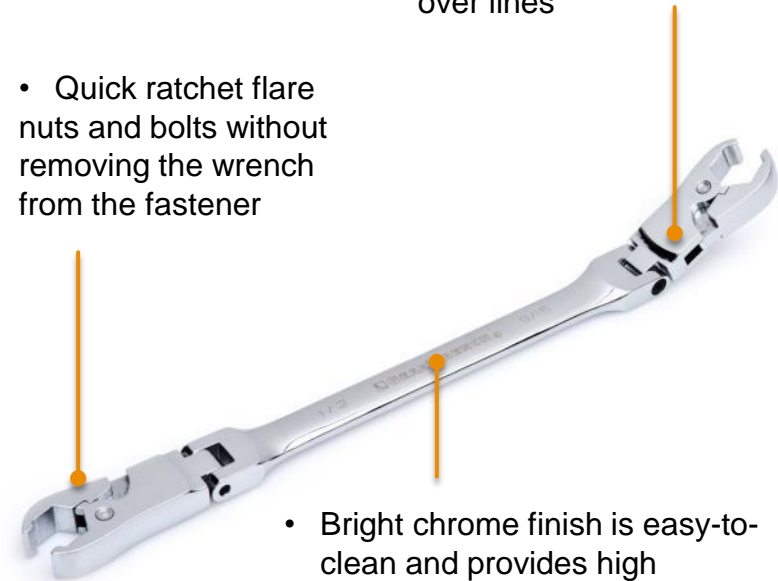

- Quick ratchet flare nuts and bolts without removing the wrench from the fastener

- Bright chrome finish is easy-to-clean and provides high visibility

Auto Specialty

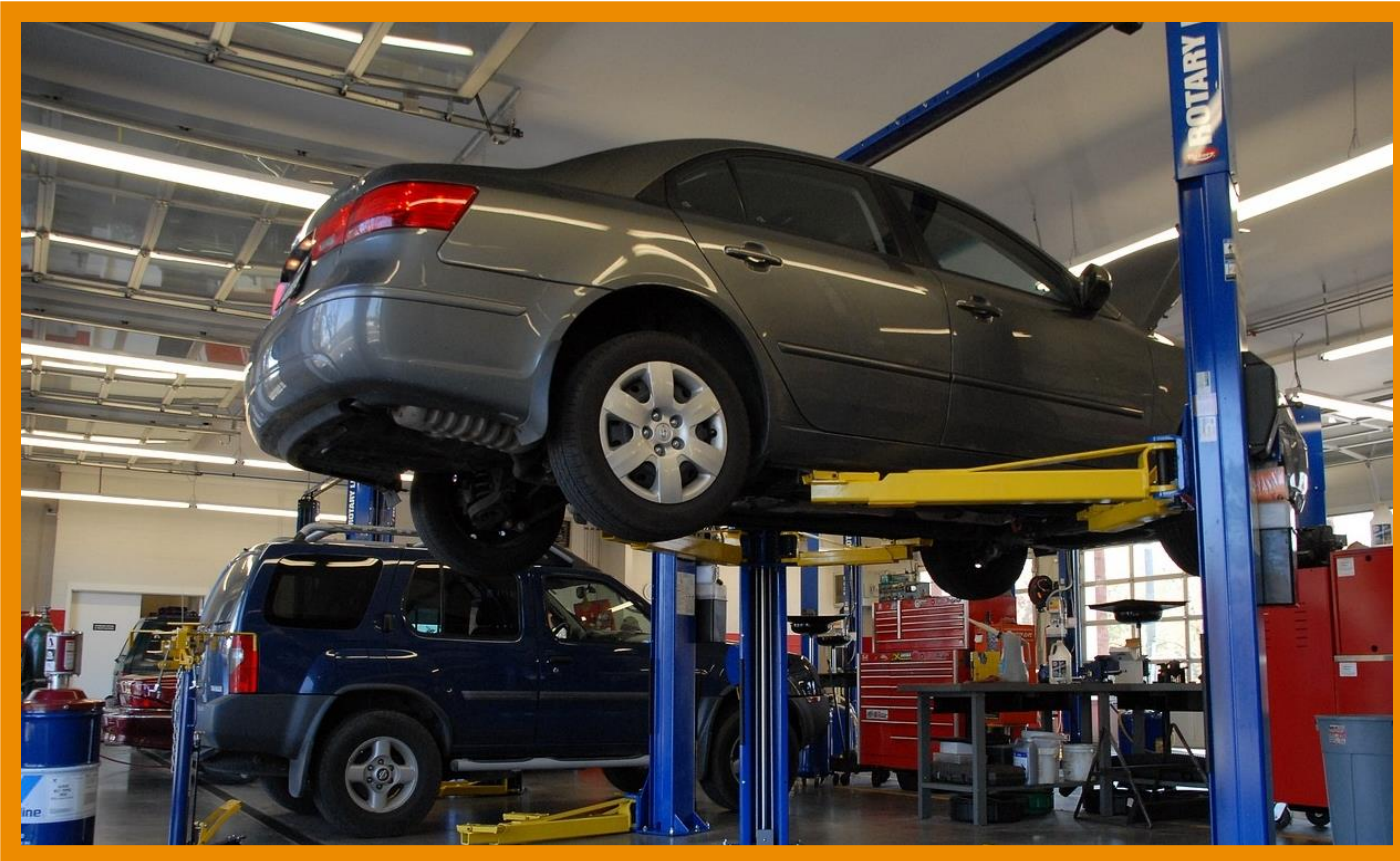

Auto Specialty

Hook and Pick Sets

Product Information

- | | |
|---------------------|---|
| Features & Benefits | <ul style="list-style-type: none"> ▪ Excellent Combination of Performance ▪ Blades are Securely Fixed in the Handle So They Do Not Twist During Use ▪ Tri-Lobe Dual Material Ergonomic Handle for Comfort and Grip ▪ Oil and Solvent Resistant Handle ▪ Chrome Plated Alloy Steel Blade for Strength and Durability ▪ Laser Etched Part Number on Blade ▪ Packed in a Vacuum Formed Tray Designed to Fit in drawers ▪ Meet or Exceed ASME requirements ▪ Open stock items are also available |
|---------------------|---|

Art. No	Description
----------------	--------------------

84010	8 Pc. Long Hook & Pick Set
84040	Mini Hook & Pick Set
84000D	Hook & Pick Set
84020	4Pc Heavy Duty Hook & Pick Set

Strength

- Blades are securely fixed in the handle so they do not twist during use
- Resistant to gas, brake fluid, anti-freeze and other solvents
- Alloy Steel Blade for durability



- Laser Etched Sku Number on blade
- Full Polish Chrome for corrosion resistance
- 14" Overall Length

Description	Tip Style	Overall Length	84040	84000D	84010	84020
			4 Pc. Mini Hook & Pick Set	7 Pc. Hook & Pick Set	8 Pc. Long Hook & Pick Set	4 Pc. Heavy-Duty Long Hook & Pick Set
3-1/8" Mini Full Hook	Full Hook	6-1/2"	•	•		
3-1/8" 90 Degree Mini Hook	90 Degree	6-1/2"	•	•		
3-1/8" Straight Mini Pick	Straight	6-1/2"	•	•		
3-1/8" Mini Offset Hook	Offset	6-1/2"	•	•		
Long Full Hook	Full Hook	9"			•	
Long 90 Degree Pick	90 Degree	9"			•	
Long 45 Degree Pick	45 Degree	9"			•	
Long Double Angle Pick	Double Angle	9"			•	
Long Complex Pick	Complex	9"			•	
Long Angle Hook Pick	Angle Hook	9"			•	
Long Combination Pick	Combination	9"			•	
Long Straight Pick	Straight	9"			•	
4" Hose Pick Puller	Hook	9-1/2"		•		
4-1/2" Awl	Straight	9-1/4"		•		
5" Cotter Pin Puller	Hook	8"		•		
Heavy-Duty Full Hook	Full Hook	14"				•
Heavy-Duty Straight Pick	Straight	14"				•
Heavy-Duty 90 Degree Pick	90 Degree	14"				•
Heavy-Duty Combination Pick	Combination	14"				•

Auto Specialty

External Thread Restorer Files

Product Information

Features & Benefits	<ul style="list-style-type: none"> ▪ Excellent Combination of Performance ▪ Files Both Right and Left-Hand Threads ▪ Features Long-Lasting, Fast-Cutting Teeth ▪ Restore External Threads by Filing ▪ Overlap Several Good Threads with File then File Damaged Threads
---------------------	---



Art. No	Description
---------	-------------

2228D	Metric External Thread Restorer File, Pitch (0.75, 1.00, 1.25, 1.50, 1.75, 2.00, 2.50, 3.00mm)
2229D	SAE External Thread Restorer File, Pitch (11, 12, 13, 14, 16, 18, 20, 24)

Auto Specialty

Piston Ring Compressors

Product Information

- | | |
|---------------------|--|
| Features & Benefits | <ul style="list-style-type: none"> ▪ Excellent Combination of Performance ▪ Use Compressor to Install Pistons 3-1/2 to 6-1/2" (89 to 164mm) in Diameter ▪ Positive Lock Action Provides Positive Compression and Fingertip Release ▪ Heavy Spring Steel Compresses the Stiffest Rings Evenly ▪ Tool is Beaded Along Lower Edge to Prevent Compressor From Entering the Cylinder |
|---------------------|--|

Art. No	Description
---------	-------------

1723N	PISTON RING COMPRESSOR 89-164MM, 3-1/2"
1724N	PISTON RING COMPRESSOR 89-177MM, 6-1/2"
2284N	PISTON RING COMPRESSOR 54-127MM, 3-1/2"
1119D	Piston Ring Compressor Band (2-7/8" to 3-1/8")
1120D	Piston Ring Compressor Band (3-1/8" to 3-3/8")
1121D	Piston Ring Compressor Band (3-3/8" to 3-5/8")
1122D	Piston Ring Compressor Band (3-5/8" to 3-7/8")
1123D	Piston Ring Compressor Band (3-7/8" to 4-1/8")



Auto Specialty

Oil Filter Wrenches

Product Information

- | | |
|---------------------|---|
| Features & Benefits | <ul style="list-style-type: none"> ▪ 2322W: Extra Wide 3" Band for Better Grip and Reduced Canister Damage ▪ 2029DD: For Hard-To-Reach Areas, Use This Wrench in Place of 190 to Remove Filters 3-7/16" to 3-3/4" (87 to 95mm) in Diameter. To Use, Turn Filter With 3/8" Square Drive Tools Band Will Not Crush Filter ▪ 2322W:Wrenches are Designed for High Torque Requirements of Truck Filters and Used With 1/2" Square Drive Tools. 1-1/2" Wide Bands for Added Strength and Increased Grip Area |
|---------------------|---|



2322W



2029DD



2320D

Art. No	Description
2029DD	Square Drive Oil Filter Wrench (3-7/16" to 3-3/4")
2320D	Heavy Duty Oil Filter Wrench (3-3/4" to 4-1/2")
2322W	Wide Heavy Duty Oil Filter Wr. (4-3/4" to 5-1/2")

Auto Specialty

Pro Swivoil™ Filter Wrenches

Product Information

- | | |
|---------------------|---|
| Features & Benefits | <ul style="list-style-type: none"> ▪ Stainless and Plated Steel Material Band for Lifetime Corrosion Resistance ▪ Dimpled for Extra Gripping Power ▪ Specially Designed to Fit Today's Oil Filters ▪ 180 Degree Swivel Action ▪ Cushion Grip Dual Material Handle Provides Greater Comfort and Better Gripping Force |
|---------------------|---|

Art. No	Description
---------	-------------

3941	Pro Swivoil™ Filter Wrench - Small (64 to 76mm)
3942	Pro Swivoil™ Filter Wr.- Medium (73 to 83mm)
3943	Pro Swivoil™ Filter Wrench - Large (89 to 99mm)
3944	Pro Swivoil™ Filt. Wr. – Extr Large (96 to 111mm)

GearWrench offers some of the most complete lines of Oil Filter Tools for almost all makes and models.



Auto Specialty

Other Products

DIGITAL GAUGES

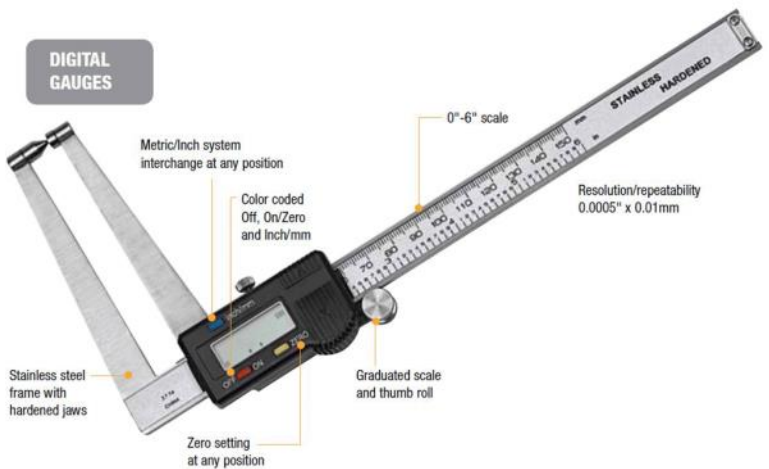

TESTING EQUIPMENT

GearWrench offers a wide range of automotive testing equipment such as this universal compression tester kit



AUTOMOTIVE SERVICE KITS

Service kits, such as this disc/drum brake kit, contain all the tools required for a specific application. Most are available in a convenient and sturdy case.



15 Piece Brake Service Kit

PULLERS



Storage



Storage

Tool Bag and Rails

Product Information

Catalog No	83147
Features & Benefits	<ul style="list-style-type: none"> ▪ All Weather Durable Tote Bag ▪ Tools Pictured Not Included

Product Information

Features & Benefits	<ul style="list-style-type: none"> ▪ All Weather Durable Tote Bag ▪ Made of Durable Glass Nylon ▪ Includes 13 Socket Clips ▪ Patented Sliding Clip System Allows for Clips to Slide Within Rail and be Configurable ▪ Drilled at End for Easy Attachment to Wall, Workbench, or Drawer
---------------------	---

Art. No Description

83102	1/2 Drive Socket Rail
83105	1/4 Drive Socket Rail
83107	3/8 Drive Socket Rail
83108	1/2 Drive Socket Rail
83101D	3/8 Drive Socket Rail
83106D	1/4 Drive Socket Rail



16'' Tool Bag



Storage

XL Series Tool Cabinets and Drawers

Product Information

- | | |
|---------------------------------------|--|
| <p>Features & Benefits</p> | <ul style="list-style-type: none"> ▪ Large Handles are easy to grab and “Trigger-lock” release provides assured open and close position. ▪ Auto return closes drawers in the last 1” to insure closure ▪ Barrel lock resists breakage and improved security ▪ Double ball bearing on larger drawers for increased capacity |
|---------------------------------------|--|

Art. No	Description
---------	-------------

83158	53" 9 Drawer Roll. Cabinet, XL Series-Black/Silver
83157	42" 11 Drawer Roll. Cabinet, XL Series-Black/Silver
83155	26" 7 Drawer Roller Cabinet, XL Series- Black/Silver
83152	32" 2 Drawer Tool Cart, XL Series - Black/Silver
83153	32" 4 Drawer Tool Cart, XL Series - Black/Silver
83156	42" 8 Drawer Chest, XL Series - Black/Silver
83154	26" 4 Drawer Chest, XL Series - Black/Silver



83158



83153



83156

Commercial Information

Product Brochures

GEARWRENCH
1/2" DR. 1/4" - 3/4" Drive - Mechanics Hand Tool Set - 80943

ACCESS STRENGTH DESIGN

Strength
• One Piece High Carbon Steel
• 100% Heat Treated
• 100% Insulated
• 100% Polished

Access
• 100% Insulated
• 100% Polished

Design
• 100% Insulated
• 100% Polished

80943

GEARWRENCH
3/4" DR. 1/4" - 3/4" Drive - Mechanics Hand Tool Set - 80944

ACCESS STRENGTH DESIGN

Strength
• One Piece High Carbon Steel
• 100% Heat Treated
• 100% Insulated
• 100% Polished

Access
• 100% Insulated
• 100% Polished

Design
• 100% Insulated
• 100% Polished

80944

GEARWRENCH
SPEED & STRENGTH - Mechanics Hand Tool Set - 80945

SPEED STRENGTH ACCESS

80945

GEARWRENCH
81 AIR IMPACT WRENCHES
3/8" DRIVE MODEL 80100
1/2" DRIVE MODEL 80100
3/4" DRIVE MODEL 80170

81 MODEL

80100 80100 80170

GEARWRENCH
SPEED STRENGTH ACCURACY

80946

GEARWRENCH
SPEED STRENGTH ACCURACY

80947

GEARWRENCH
Hooks, Picks, Magnets, Pick-Up and Inspection Tools

HOOKS & PICKS MAGNETIC TOOLS INSPECTION TOOLS

80948

GEARWRENCH
IMPACT SOCKET DRIVE

STRENGTH SPEED DURABILITY

80949

GEARWRENCH
Light Offset Pliers, Standard Pliers

SPEED STRENGTH PERFORMANCE

80950

GEARWRENCH
Pliers (81)

STRENGTH STRENGTH ACCESS

80951

GEARWRENCH
Fast-Loading Tap & Die Process

INNOVATION SPEED PRECISION

80952

GEARWRENCH
BATTERY DRIVE

SPEED STRENGTH ACCESS

80953

GEARWRENCH
BET SOCKET DRIVE

BET SOCKETS 1/2" DR. 1/4" - 3/4" DR. 1/2" DR.

80954

GEARWRENCH
NEW 3/4" DR. Mechanics Hand Tool Set - 80955

ACCESS STRENGTH DESIGN

80955

GEARWRENCH
Professional Fixed Tip Snap Ring Pliers

PERFORMANCE STRENGTH ACCESS

80956

GEARWRENCH
Inching Dry Bars and Standard Dry Bars

SPEED STRENGTH ACCESS

80957

GEARWRENCH
SPEED STRENGTH ACCURACY

80958

* Please click on the pictures to see brochures

Commercial Information

Product Brochures

GEARWRENCH
Standard Ratchets - Precision Ratcheting Mechanisms

GEARWRENCH
3-Position Ratcheting Screwdriver with LED Lights

GEARWRENCH
PLIER SERIES
Flat/Beak Conversion Pliers, One-Hand Use

GEARWRENCH
120° Flat Head Ratchet - 120 Positions, 3 Degree Ratcheting Arc

GEARWRENCH
120° Ratchet - 120 Positions, 3 Degree Ratcheting Arc

GEARWRENCH
Ratcheting Plus-Flare Nut Wrench

GEARWRENCH
Building Gearwrench Wrenches

GEARWRENCH
New 24-TOOTH RATCHET Provides Better Access and Greater Strength

GEARWRENCH
MEETING YOUR END RATCHETING WRENCH

GEARWRENCH
31 Gearbox™ Ratcheting Wrenches

GEARWRENCH
Tool Storage Solutions

GEARWRENCH
3X Centralized Ratcheting Wrenches

GEARWRENCH
Stubby Centralized Ratcheting Wrenches

GEARWRENCH
Centralized Ratcheting Wrenches

GEARWRENCH
Beetlelike Ratcheting Wrenches

GEARWRENCH
In-Locking Flat Head Ratcheting Wrenches

GEARWRENCH
Flat Head Ratcheting Wrenches

Metric	Series	Material	Weight	Length	Price
1/4"	8700	8620	0.15	100	\$12.99
3/8"	8700	8620	0.25	150	\$19.99
1/2"	8700	8620	0.45	200	\$29.99
3/4"	8700	8620	0.85	250	\$49.99
1"	8700	8620	1.50	300	\$79.99
1 1/4"	8700	8620	2.50	350	\$129.99
1 1/2"	8700	8620	3.00	400	\$159.99
2"	8700	8620	5.00	450	\$249.99
2 1/2"	8700	8620	8.00	500	\$399.99
3"	8700	8620	12.00	550	\$599.99
3 1/2"	8700	8620	18.00	600	\$899.99
4"	8700	8620	25.00	650	\$1299.99
4 1/2"	8700	8620	35.00	700	\$1899.99
5"	8700	8620	50.00	750	\$2799.99
5 1/2"	8700	8620	70.00	800	\$3999.99
6"	8700	8620	100.00	850	\$5999.99
6 1/2"	8700	8620	140.00	900	\$8999.99
7"	8700	8620	200.00	950	\$13999.99
7 1/2"	8700	8620	280.00	1000	\$20999.99
8"	8700	8620	400.00	1050	\$30999.99
8 1/2"	8700	8620	550.00	1100	\$45999.99
9"	8700	8620	800.00	1150	\$69999.99
9 1/2"	8700	8620	1100.00	1200	\$104999.99
10"	8700	8620	1500.00	1250	\$159999.99
10 1/2"	8700	8620	2100.00	1300	\$239999.99
11"	8700	8620	2900.00	1350	\$359999.99
11 1/2"	8700	8620	4000.00	1400	\$549999.99
12"	8700	8620	5500.00	1450	\$849999.99
12 1/2"	8700	8620	7500.00	1500	\$1249999.99
13"	8700	8620	10500.00	1550	\$1849999.99
13 1/2"	8700	8620	14500.00	1600	\$2749999.99
14"	8700	8620	20000.00	1650	\$4049999.99
14 1/2"	8700	8620	28000.00	1700	\$5949999.99
15"	8700	8620	39000.00	1750	\$8949999.99
15 1/2"	8700	8620	54000.00	1800	\$13449999.99
16"	8700	8620	75000.00	1850	\$20449999.99
16 1/2"	8700	8620	105000.00	1900	\$30449999.99
17"	8700	8620	145000.00	1950	\$45449999.99
17 1/2"	8700	8620	200000.00	2000	\$67449999.99
18"	8700	8620	280000.00	2050	\$100449999.99
18 1/2"	8700	8620	390000.00	2100	\$150449999.99
19"	8700	8620	540000.00	2150	\$224499999.99
19 1/2"	8700	8620	750000.00	2200	\$334499999.99
20"	8700	8620	1050000.00	2250	\$504499999.99

* Please click on the pictures to see brochures

Commercial Information

Product Brochures



* Please click on the pictures to see brochures



Commercial Information

Product Videos



[Electronic Torque Wrenches \(85076 & 85077\)](#)



[80942 Mechanics Tool Set](#)



[120XP 3° Ratcheting Wrenches](#)



[Pivot Force™ Pliers](#)



[120XP™ Ratchet \(3° Swing\)](#)



[84 Tooth Ratchet, Ratcheting Flare Nut Wrench and Mid Length Sockets](#)



[Tools Ratcheting Puller \[3624, 3625, 3626, 3627 & 3628\]](#)



[Electronic Torque Wrench With Angle \[85073 & 85074\]](#)



[XL Locking Flex Ratcheting Wrenches](#)



[XL GearBox™ Ratcheting Wrenches](#)



[XL Combination Ratcheting Wrenches](#)

* Please click on the link to watch Youtube videos

Commercial Information

Product Videos



[XL Spline Ratcheting Wrenches](#)



[Reversible Combination Ratcheting Wrenches](#)



[QuadBox™ Ratcheting Wrenches](#)



[Jumbo Combination Ratcheting Wrenches](#)



[Stubby Combination Ratcheting](#)



[Combination Ratcheting Wrenches](#)



[S-Shape Reversible Double Box Ratcheting Wrench \[85299 & 85201\]](#)



[Half Moon Reversible Double Box Ratcheting Wrench \[9850 & 9840\]](#)



[Flex Combination Ratcheting Wrenches](#)



[Indexable Nail Puller \[82212\]](#)



[Indexing Pry Bars](#)

* Please click on the link to watch Youtube videos