

EAGLE

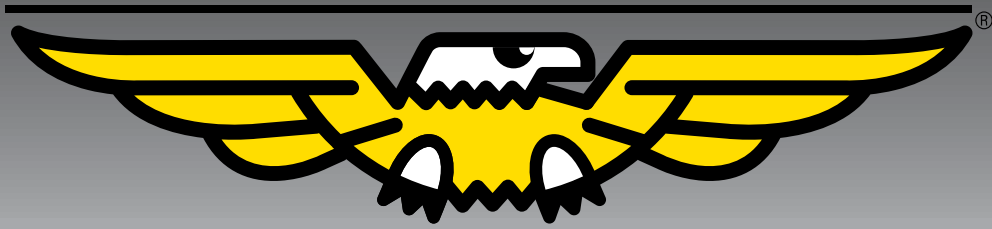

PROTECTING PEOPLE, PROPERTY AND THE PLANET®

Since 1894

eagle-mfg.com



Product Catalog

SAFETY CABINETS

SAFETY CANS

SPILL CONTAINMENT

POLY DRUMS

MATERIAL HANDLING





A note from the President...

After nearly 125 years in business, Eagle Manufacturing Company continues the tradition of providing innovative quality products and services to our customers. Although times are much different today than they were when the company started in 1894, our early mission of Protecting People, Property and the Planet® has served our customers well through the years. In support of this mission, and to keep our customers as priority one, we continue to strive toward excellence and quality in all that we do.

We have updated the Eagle brand to better reflect the quality, breadth and depth of products and services we provide for our customers. We have updated our Compliance Solutions product catalog, created new product data sheets and a comprehensive product-featured Website (eagle-mfg.com), Flexible Containment catalog, Poly Drums catalog and other marketing materials that feature the updated branding.

We also support our mission by manufacturing the world's largest line of industrial safety and hazardous materials handling products, including safety cabinets, safety cans, spill containment, poly drums, guards/protectors, traffic safety and material handling products, representing more than 1,000 products. New product innovation includes several new models of poly drums, flexible containment berms, metal spill pallets, light-weight security bollards and machine guards, poly rack guards, poly spill kit and industrial waste carts, and our new patent-pending modular poly cabinet line.

New product innovation requires expanded production capacity, and expanded capacity requires new manufacturing, warehousing and distribution space. In past couple of years, we have expanded our plastics production capacity and our distribution center to nearly 100,000sf, and we have added a 50,000sf fabrication center with engineering testing lab.

We are proud to say that all our products are Made in the USA, by the best craftsmen in the industry. When you purchase an Eagle product, you are assured of the highest quality products, with the most innovative features, at the best value on the market, and supported by exceptional customer service.

I would like to thank all our customers for your continued loyalty, support and trust as we work together in the mission to Protect People, Property and the Planet®.

Joe C. Eddy
Joseph C. Eddy - President/CEO



"Our Mission is to Excel in Manufacturing and Marketing and to be the Supplier of Choice to our Customers."



SAFETY CABINETS

- 4 Standard Cabinet Features
- 6 Flammable Storage Cabinets
- 8 Tower™ Cabinets
- 9 Paint & Ink Tower™ & Paint & Ink Cabinets
- 10 Drum Safety & Haz-Mat Cabinets
- 11 Pesticide Cabinets
- 12 Metal Acid & Corrosive Cabinets
- 13 Poly Acid & Corrosive Cabinets
- 14 Modular *Quik-Assembly™* Poly Cabinets
- 16 Office Supply Cabinets
- 17 Cabinet Accessories

SAFETY CANS

- 19 Cantastic – Standard Safety Can Features
- 20 Type I Galvanized Safety Cans – Flammables & Diesel
- 21 Type I Galvanized Safety Cans – Kerosene & Combustibles
- 22 Type II Safety Cans – Flammables, Diesel, Kerosene & Combustibles
- 23 Lab & Faucet Cans & DOT Cans
- 24 Disposal Cans – Poly, Galvanized, Stainless & Specialty Use Cans
- 25 Plunger, Bench, Daub Cans
- 26 Poly Waste Cans
- 27 Standard Cigarette Receptacle, Butt Cans & SafeSmoker™

SPILL CONTAINMENT

- 29 Spill Containment Features
- 30 Budget Basin Platforms
- 31 Spill Pallets
- 32 Modular Spill Platforms
- 34 Metal Spill Pallets & Drum Stackers
- 36 Outdoor Drum Storage & Workstations
- 37 IBC Containment Units, Boxes & e-CARTS
- 38 Spill Containment Sumps
- 39 Drum Dollie, Bogie & eCart
- 40 Utility Tray, Single Drum Containment Unit
- 41 Mobile Spill Platform and Drum Accessories

FLEXIBLE SPILL CONTAINMENT

- 42 SpillNEST™ – Quik-Deploy & Folding
- 44 SpillNEST™ Berm with Removable Sidewalls
- 46 Talon™ SX & Spill Berm & SpillNEST™ Drip Pads
- 48 Talon™ Drive-In/Out, SpillNEST™ Rail Containment & Pools
- 49 DripNEST™ Leak Diverter, Hose Wraps & Bibbs
- 50 StormNEST™ Basin Inserts, Drain Covers & Berm Accessories

POLY DRUMS

- 52 Poly Drum Features
- 53 10-Gallon (37.9 L) Drums
- 54 14-Gallon (53 L) Drums
- 55 20-Gallon (75.7 L) Drums
- 56 30-Gallon (113.6 L) Drums
- 57 55-Gallon (208.2 L) Drums
- 60 65-Gallon to 95-Gallon (246 L - 359.6 L) Drums

MATERIAL HANDLING

- 62 Guards & Protectors Features
- 64 Bollard Posts, Machine Guards, Wall & Corner Protectors
- 65 Column Protectors & Rack Guard
- 66 Bollards, Bumper Post Sleeves & e-CARTS
- 68 Parking Stops, Poly Guide-Post Delineators™, Bollard Post Sleeves & Combos
- 70 Portable Dockplate & Ramps, Fixed Dockplates, Airplane Service Ramp

With more than **200 years** of combined **Eagle experience**, we are your sales team; and, we're ready to help!



Front Row: Ingrid, Cheryl, Misty, Lori
 Middle Row: Jessica, Lois, Cindy, Joyce
 Back Row: Matt, Tracy, Mike, Steve
 Not pictured: Kelly and Ryan

Photo by Ruthylee Photography

©EAGLE MANUFACTURING COMPANY, 2017 Eagle Manufacturing Company reserves the right to change construction, specifications, prices and terms without notice, and without obligation as to products already shipped.



SAFETY CABINETS

A leader in the manufacturing of Safety Cabinets for nearly 50 years, Eagle Manufacturing has set the industry standard for high-quality Safety Cabinets for the storage of flammables and other liquids. In 2011, Eagle designed a new state-of-the-art production facility and created a cabinet design incorporating improved convenience and safety features. Our Safety Cabinet product line is designed and manufactured to best meet the ever-changing needs of today's business, industrial and laboratory environments and is made in the USA.





Eagle Steel Safety Cabinet features include:

- Reinforced double wall construction with 1½ in. (3.8 cm.) air space on sides, top, bottom, back and doors
- Constructed of 18 gauge steel
- Lead-free, high-gloss, baked-on powder finish
- Continuous piano hinges
- Ground connection
- Four adjustable galvanized leveling legs
- Trilingual warning labels
- 2 in. (5.1 cm.) raised leakproof sill
- Adjustable galvanized steel shelves that hold 350 lbs. (158.8 kg.) Uniform Distributed Load (UDL)
- Internal and external welded construction
- Two 2 in. (5.1 cm.) internal vents with fire baffle and cap
- Flush mounted door handle with key lock
- Three-point latch system
- 4¾ in. (12.1 cm.) centers for shelf brackets
- Self-latching doors
- Door closings: Manual Close (180° Opening)
Self-Closing (90° Opening)

(Available in 2- (7.6 L) to 110- (426.4 L) gallon sizes. Manual Close or Self-Closing.)

SAFETY CABINETS

FLAMMABLE LIQUID SAFETY CABINETS



Capacity (Gal.)	7.6 L 2 gal.	15.2 L 4 gal.	45.5 L 12 gal.	56.7 L 15 gal.	60.6 L 16 gal.	83.3 L 22 gal.	90.9 L 24 gal.	90.9 L 24 gal.								
Common Name	Bench Top	Bench Top	Space Saver	Add On	Space Saver	Under Counter	Wall-Mount	Space Saver								
Model Numbers	1900	1903	1924	ADD 14	1905	1970	1975	2310								
Door Styles	Self Close: 1901	Self Close: 1904	Self Close: 1925	Manual Close: ADD 15	Manual Close: 1906	Manual Close: 1971	Manual Close: 1976	Sliding Self Close: 1923								
	–	–	–	–	–	–	–	–								
Outside Dimensions	cm. Width: 44.5 Depth: 45.8 Height: 43.9	in. 17½ 18 17¼	cm. 44.5 45.8 57.2	in. 17½ 18 22½	cm. 58.5 45.8 88.9	in. 23 18 35	cm. 109.3 45.8 56.6	in. 43 18 22¼	cm. 58.5 45.8 111.8	in. 23 18 44	cm. 88.9 55.9 88.9	in. 35 22 35	cm. 109.3 30.5 111.8	in. 43 12 44	cm. 58.5 45.8 165.1	in. 23 18 65
Inside Dimensions	cm. Width: 36.9 Depth: 38.1 Height: 36.2	in. 14½ 15 14¼	cm. 36.9 38.1 49.6	in. 14½ 15 19½	cm. 50.8 38.1 81.3	in. 20 15 32	cm. 101.6 38.1 48.9	in. 40 15 19¼	cm. 50.8 38.1 104.2	in. 20 15 41	cm. 81.3 48.3 81.3	in. 32 19 32	cm. 101.6 22.9 104.2	in. 40 9 41	cm. 101.6 22.9 157.5	in. 40 9 62
No. of Shelves	1	1	1	Optional	1	1	3	3								
Extra Shelf Model No.	1902	1902	1919	1915	1919	1972	1977	1919								
Shelf Depth	37.5 cm. 14¾ in.	37.5 cm. 14¾ in.	37.5 cm. 14¾ in.	37.5 cm. 14¾ in.	37.5 cm. 14¾ in.	47.7 cm. 18¾ in.	22.3 cm. 8¾ in.	37.5 cm. 14¾ in.								
Maximum Weight	31.3 kg. 69 lbs.	37.2 kg. 82 lbs.	64.5 kg. 142 lbs.	72.6 kg. 160 lbs.	75.7 kg. 167 lbs.	90.7 kg. 200 lbs.	104.3 kg. 230 lbs.	102.5 kg. 226 lbs.								
Compliance																
Approvals	–	–														

ALL CABINETS INCLUDE STANDARD FEATURES & BENEFITS SHOWN ON PAGE 5



Did you know?

Improper storage and handling of flammable liquids is the leading cause of industrial fires.

All steel cabinets meet NFPA Code 30 and OSHA specifications. Self-closing models meet Uniform Fire Code and NFPA Code One requirements.



113.6 L 30 gal.	170.4 L 45 gal.	181.7 L 48 gal.	227.2 L 60 gal.	227.2 L 60 gal.	227.2 L 60 gal.	340.7 L 90 gal.
Standard 30	Standard 45	Deep Space Saver	Single Door 60	Standard 60	Work Bench	Standard 90
3010 1932 1930	4510 1947 1945	4610 1946 -	6110 1961 -	6010 1962 -	6410 1964 -	9010 1992 -
cm. in. 109.2 43 45.8 18 111.8 44	cm. in. 109.3 43 45.8 18 165.1 65	cm. in. 58.5 23 86.4 34 165.1 65	cm. in. 79.4 31¼ 79.4 31¼ 165.1 65	cm. in. 79.4 31¼ 79.4 31¼ 165.1 65	cm. in. 109.3 43 86.4 34 111.76 44	cm. in. 109.3 43 86.4 34 165.1 65
cm. in. 101.6 40 38.1 15 104.2 41	cm. in. 101.6 40 38.1 15 157.5 62	cm. in. 50.8 20 78.8 31 157.5 62	cm. in. 71.8 28¼ 71.8 28¼ 157.5 62	cm. in. 71.8 28¼ 71.8 28¼ 157.5 62	cm. in. 101.6 40 78.8 31 104.2 41	cm. in. 101.6 40 78.8 31 157.5 62
1 1915	2 1915	3 1919(2)	2 1911	2 1911	1 1915(2)	2 1915(2)
37.5 cm. 14 ¾ in.	37.5 cm. 14 ¾ in.	76.2 cm. 30 in.	71.2 cm. 28 in.	71.2 cm. 28 in.	76.2 cm. 30 in.	76.2 cm. 30 in.
109.4 kg. 241 lbs.	146.1 kg. 322 lbs.	149.7 kg. 330 lbs.	163.2 kg. 360 lbs.	165.7 kg. 363 lbs.	154.2 kg. 340 lbs.	216.4 kg. 477 lbs.

Three door styles
to choose from:

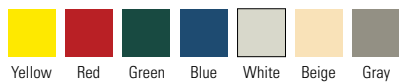

1947 2 Door
Manual Close



4510 2 Door
Self-Closing



1945 Sliding Door
Self-Closing
(30- & 45-gallon only)



SAFETY CABINETS

TOWER™ SAFETY CABINETS [YELLOW ONLY]

PAINT & INK



Capacity (Gal.)

45.4 L 12 gal.	60.6 L 16 gal.	113.6 L 30 gal.	170.4 L 45 gal.	227.2 L 60 gal.	340.7 L 90 gal.
-------------------	-------------------	--------------------	--------------------	--------------------	--------------------

151.4 L
40 gal.

Common Name

Space Saver	Space Saver	Tower 30	Tower 45	Tower 60	Tower 90
--------------------	--------------------	-----------------	-----------------	-----------------	-----------------

Tower 40

Model Numbers
Self Close:
Door Styles
Manual Close:
Sliding Self Close:

1924LEGS 1925LEGS —	1905LEGS 1906LEGS —	3010LEGS 1932LEGS —	4510LEGS 1947LEGS —	6010LEGS 1962LEGS —	9010LEGS 1992LEGS —
---	---	---	---	---	---

Cabinets are
PI-32LEGS**

Outside Dimensions
Width:
Depth:
Height:

	cm.	in.	cm.	in.	cm.	in.	cm.	in.	cm.	in.	cm.	in.
Width:	58.5	23	58.5	23	109.2	43	79.4	31¼	109.2	43	109.2	43
Depth:	45.8	18	45.8	18	45.8	18	79.4	31¼	86.4	34	45.8	18
Height:	99.1	39	121.9	48	121.9	48	175.3	69	175.3	69	121.9	48

	cm.	in.
Width:	109.2	43
Depth:	45.8	18
Height:	121.9	48

Inside Dimensions
Width:
Depth:
Height:

	cm.	in.	cm.	in.	cm.	in.	cm.	in.	cm.	in.	cm.	in.
Width:	50.8	20	50.8	20	101.6	40	71.8	28¼	101.6	40	101.6	40
Depth:	38.1	15	38.1	15	38.1	15	71.8	28¼	78.8	31	38.1	15
Height:	81.3	32	104.2	41	104.2	41	157.5	62	157.5	62	104.2	41

	cm.	in.
Width:	101.6	40
Depth:	38.1	15
Height:	104.2	41

No. of Shelves
Extra Shelf Model No.

1 1919	1 1919	1 1915	2 1915	2 1911	2 1915(2)
------------------	------------------	------------------	------------------	------------------	---------------------

3
1915

Shelf Depth

37.5 cm. 14¾ in.	37.5 cm. 14¾ in.	37.5 cm. 14¾ in.	37.5 cm. 14¾ in.	71.2 cm. 28 in.	76.2 cm. 30 in.
---------------------	---------------------	---------------------	---------------------	--------------------	--------------------

37.5 cm.
14¾ in.

Maximum Weight

67.2 kg. 148 lbs.	78.9 kg. 174 lbs.	115.2 kg. 254 lbs.	152 kg. 335 lbs.	172.4 kg. 380 lbs.	224.1 kg. 494 lbs.
----------------------	----------------------	-----------------------	---------------------	-----------------------	-----------------------

120.2 kg.
265 lbs.

Compliance

--	--	--	--	--	--

Approvals

--	--	--	--	--	--

ALL CABINETS INCLUDE STANDARD FEATURES & BENEFITS SHOWN ON PAGE 5

****PI-32LEGS**
is Manual Close

Tower cabinets include 4 inch adjustable legs for the added benefits of:

- Placing cabinets over floor or wall ventilation
- Providing easy cleaning under cabinet
- Protecting the cabinet in areas where floor moisture is a concern
- Moving with a forklift or pallet jack

Did you know?

The use of approved safety cans is your first layer of protection against fire. Storage of safety cans in approved safety cabinets provides your second layer of protection.



TOWER™ SAFETY CABINETS

PAINT & INK SAFETY CABINETS

227.2 L 60 gal.	363.4 L 96 gal.	90.8 L / 24 gal. (168 Aerosol Cans)	113.6 L / 30 gal. (252 Aerosol Cans)	151.4 L 40 gal.	227.2 L 60 gal.	363.4 L 96 gal.
Tower 60	Tower 96	Aerosol Can Storage	Aerosol Can Storage	Standard 40	Standard 60	Standard 96

available in yellow - when ordering add a "Y" before model number (to order 1975 or 1976 in yellow drop the RED from the model number)

PI-47LEGS		PI-62LEGS		1975-RED 1976-RED	PI-7710 PI-77	PI-3010 PI-32 PI-30	PI-4510 PI-47 PI-45	PI-6010 PI-62	
cm.	in.	cm.	in.	cm.	in.	cm.	in.	cm.	in.
109.2	43	79.4	31¼	109.2	43	109.2	43	79.4	31¼
45.8	18	79.4	31¼	30.5	12	45.8	18	79.4	31¼
175.3	69	175.3	69	111.8	44	111.8	44	165.1	65
cm.	in.	cm.	in.	cm.	in.	cm.	in.	cm.	in.
101.6	40	71.8	28¼	101.6	40	101.6	40	101.6	40
38.1	15	71.8	28¼	22.9	9	38.1	15	38.1	15
157.5	62	157.4	62	104.1	41	104.1	41	157.5	62
5 1915	5 1911	3 1977	5 1977	3 1915	5 1915	5 1911			
37.5 cm. 14¾ in.	71.2 cm. 28 in.	22.2 cm. 8¾ in.	22.3 cm. 8¾ in.	37.5 cm. 14¾ in.	37.5 cm. 14¾ in.	71.2 cm. 28 in.			
165.6 kg. 365 lbs.	173.3 kg. 382 lbs.	101.6 kg. 224 lbs.	136.1 kg. 300 lbs.	114.8 kg. 253 lbs.	160.2 kg. 353 lbs.	170.1 kg. 375 lbs.			

Paint & Ink cabinets include:

- Additional shelves for storage of one-gallon (3.8 L) paint or ink cans, or for aerosol cans
- Capacity based on the number of one-gallon (3.8 L) paint cans
- Aerosol cabinets include wall-mounting brackets. 24-gallon (90.8 L) cabinet is designed to hold up to 168 12-oz. aerosol cans and the 30-gallon (113.6 L) cabinet is designed to hold up to 252 12-oz. aerosol cans



SAFETY CABINETS

DRUM SAFETY CABINETS

HAZ-MAT SAFETY CABINETS



Capacity (Gal.)	208.2 L 55 gal.	208.2 L 55 gal.	416.4 L 110 gal.	208.2 L 55 gal.	416.4 L 110 gal.	227.2 L 60 gal.
Common Name	One Drum Vertical	One Drum Horizontal	Two Drum Vertical	HAZ One Drum Vertical	HAZ Two Drum Vertical	HAZ Two Drum (30 gal. Drums)
Model Numbers	2610	2810	5510	HAZ2610	HAZ5510	HAZ9010
Door Styles	Self Close: 2610 Manual Close: 1926	Self Close: 2810 Manual Close: 1928	Self Close: 5510 Manual Close: 1955	Self Close: HAZ2610 Manual Close: HAZ1926	Self Close: HAZ5510 Manual Close: HAZ1955	Self Close: HAZ9010 Manual Close: HAZ1992
Outside Dimensions	Width: 79.4 cm, 31 1/4 in. Depth: 79.4 cm, 31 1/4 in. Height: 165.1 cm, 65 in.	Width: 79.4 cm, 31 1/4 in. Depth: 122.6 cm, 48 3/4 in. Height: 127 cm, 50 in.	Width: 147.4 cm, 58 in. Depth: 80.1 cm, 31 1/2 in. Height: 165.1 cm, 65 in.	Width: 79.4 cm, 31 1/4 in. Depth: 79.4 cm, 31 1/4 in. Height: 165.1 cm, 65 in.	Width: 147.4 cm, 58 in. Depth: 80.1 cm, 31 1/2 in. Height: 165.1 cm, 65 in.	Width: 109.3 cm, 43 in. Depth: 86.4 cm, 34 in. Height: 165.1 cm, 65 in.
Inside Dimensions	Width: 71.8 cm, 28 3/4 in. Depth: 71.8 cm, 28 3/4 in. Height: 157.5 cm, 62 in.	Width: 71.8 cm, 28 3/4 in. Depth: 115 cm, 45 3/4 in. Height: 119.4 cm, 47 in.	Width: 139.7 cm, 55 in. Depth: 72.4 cm, 28 1/2 in. Height: 157.5 cm, 62 in.	Width: 71.8 cm, 28 3/4 in. Depth: 71.8 cm, 28 3/4 in. Height: 157.5 cm, 62 in.	Width: 139.7 cm, 55 in. Depth: 72.4 cm, 28 1/2 in. Height: 157.5 cm, 62 in.	Width: 101.6 cm, 40 in. Depth: 78.8 cm, 31 in. Height: 157.5 cm, 62 in.
No. of Shelves	1 Extra Shelf Model No. 1921	—	1 1922	1 1921	1 1922	1 1915(2)
Shelf Depth	37.5 cm, 14 3/4 in.	—	37.5 cm, 14 3/4 in.	37.5 cm, 14 3/4 in.	37.5 cm, 14 3/4 in.	37.5 cm, 14 3/4 in.
Maximum Weight	164.2 kg, 362 lbs.	163.3 kg, 360 lbs.	242.7 kg, 535 lbs.	177.8 kg, 392 lbs.	278.5 kg, 614 lbs.	238.2 kg, 525 lbs.
Compliance						
Approvals						

ALL CABINETS INCLUDE STANDARD FEATURES & BENEFITS SHOWN ON PAGE 5

Drum safety cabinets include:

- Drum support guides in the bottom and one shelf (vertical cabinets only)
- Roller conveyors in the bottom, one shelf and hazardous waste labels

Did you know?





















Regulations require not more than 60 gal. (227.2 L) of Class II liquids and not more than 120 gal. (454.2 L) of Class III liquids in any one safety cabinet.





PESTICIDE SAFETY CABINETS



					
					
Capacity (Gal.)	83.3 L 20 gal.	113.6 L 30 gal.	170.4 L 45 gal.	208.2 L 55 gal.	227.2 L 60 gal.
Common Name	Space Saver	Standard 30	Standard 45	One Drum Vertical	Standard 60
Model Numbers					
Door Styles Self Close: Manual Close:	PEST24 PEST25	PEST3010 PEST32	PEST4510 PEST47	PEST2610 PEST26	PEST6010 PEST62
Outside Dimensions	cm. in. 58.5 23 45.8 18 88.9 35	cm. in. 109.3 43 45.8 18 111.8 44	cm. in. 109.3 43 45.8 18 165.1 65	cm. in. 79.4 31¼ 79.4 31¼ 165.1 65	cm. in. 79.4 31¼ 79.4 31¼ 165.1 65
Inside Dimensions	cm. in. 50.8 20 38.1 15 81.3 32	cm. in. 101.6 40 38.1 15 104.2 41	cm. in. 101.6 40 38.1 15 157.5 62	cm. in. 71.8 28¼ 71.8 28¼ 157.5 62	cm. in. 71.8 28¼ 71.8 28¼ 157.5 62
No. of Shelves Extra Shelf Model No.	1 1919	1 1915	2 1915	1 1921	2 1911
Shelf Depth	37.5 cm. 14 ¾ in.	37.5 cm. 14 ¾ in.	37.5 cm. 14 ¾ in.	37.5 cm. 14 ¾ in.	71.2 cm. 28 in.
Maximum Weight	65.4 kg. 144 lbs.	110.7 kg. 244 lbs.	155.2 kg. 342 lbs.	164.2 kg. 362 lbs.	173.3 kg. 382 lbs.
Compliance					
Approvals					



Pesticide safety cabinets:

- Offer safe, secure, lockable storage of pesticides including herbicides, insecticides, fungicides and other poisons
- Provide excellent protection for companies specializing in lawn care, golf course or agricultural management
- Include poly shelf and bottom trays to help contain small spills and provide extra corrosion protection
- Are available in 100 percent polyethylene construction for storage of highly corrosive pesticides or poisons

SAFETY CABINETS

METAL ACID & CORROSIVE SAFETY CABINETS



Capacity (Gal.)	15.2 L 4 gal.	45.5 L 12 gal.	56.7 L 15 gal.	60.6 L 16 gal.	83.3 L 22 gal.	90.9 L 24 gal.	113.6 L 30 gal.
Common Name	Bench Top	Space Saver	Add-On	Space Saver	Under Counter	Space Saver	Standard 30
Model Numbers							
Door Styles	Self Close: Manual Close: Sliding Self Close:						
	CRA-1903 CRA-1904 -	CRA-1924 CRA-1925 -	ADD-CRA14 ADD-CRA -	CRA-1905 CRA-1906 -	CRA-70 CRA-71 -	CRA-2310 CRA-1923 -	CRA-3010 CRA-32 CRA-30
Outside Dimensions	Width: Depth: Height:	Width: Depth: Height:	Width: Depth: Height:	Width: Depth: Height:	Width: Depth: Height:	Width: Depth: Height:	Width: Depth: Height:
	cm. in. 44.5 17½ 45.8 18 57.2 22½	cm. in. 58.4 23 45.8 18 88.9 35	cm. in. 109.3 43 45.8 18 56.6 22¼	cm. in. 58.5 23 45.8 18 111.8 44	cm. in. 88.9 35 55.9 22 88.9 35	cm. in. 58.5 23 45.8 18 165.1 65	cm. in. 109.3 43 45.8 18 111.8 44
Inside Dimensions	Width: Depth: Height:	Width: Depth: Height:	Width: Depth: Height:	Width: Depth: Height:	Width: Depth: Height:	Width: Depth: Height:	Width: Depth: Height:
	cm. in. 36.9 14½ 38.1 15 49.6 19½	cm. in. 50.8 20 38.1 15 81.3 32	cm. in. 101.6 40 38.1 15 48.9 19¼	cm. in. 50.8 20 38.1 15 104.2 41	cm. in. 81.3 32 48.3 19 81.3 32	cm. in. 50.8 20 38.1 15 157.5 62	cm. in. 101.6 40 38.1 15 104.2 41
No. of Shelves Extra Shelf Model No.	1 CRA-1902	1 CRA-1909	Optional CRA-1914	1 CRA-1909	1 CRA-72	3 CRA-1909	1 CRA-1914
Shelf Depth	37.5 cm. 14 ¾ in.	37.5 cm. 14 ¾ in.	37.5 cm. 14 ¾ in.	37.5 cm. 14 ¾ in.	47.7 cm. 18 ¾ in.	37.5 cm. 14 ¾ in.	37.5 cm. 14 ¾ in.
Maximum Weight	37.19 kg. 82 lbs.	65.4 kg. 144 lbs.	73.1 kg. 161 lbs.	74 kg. 163 lbs.	91.7 kg. 202 lbs.	103.5 kg. 228 lbs.	110.7 kg. 244 lbs.
Compliance							
Approvals	-						

ALL CABINETS INCLUDE STANDARD FEATURES & BENEFITS SHOWN ON PAGE 5

Acid & corrosive safety cabinets include:

- Special corrosion-resistant powder coat finish on all internal and external surfaces, including shelves
- Poly shelf and bottom trays to help contain small spills and provide extra corrosion protection
- Steel cabinets are not recommended for the storage of aggressive acids such as nitric, sulfuric and hydrochloric
- Also available in 100 percent polyethylene construction for storage of aggressive acids

Did you know?

Approved safety cabinets are designed to protect the contained flammable liquids for a period of 10 minutes, giving personnel time to exit in case of fire.



MODULAR *QUIK-ASSEMBLY*TM POLY CABINETS

Eagle introduces a new line of Modular *Quik-Assembly*TM Poly Cabinets ideal for lab or industrial settings. Made of heavy duty High Density Polyethylene, these models can be assembled in minutes without tools. The 4-gallon (15.2 L) model is a stand-alone unit, while the 12-gallon (45.5 L), 24-gallon (90.9 L) and 48-gallon (181.7 L) models can be linked and stacked to create additional vertical or horizontal units. Models can be assembled with the option of the lockable doors opening to the left or right. Cabinets are also available in yellow, black, beige, white and gray in 4-gallon (15.2 L) and 12-gallon (45.5 L) models.

Features:

- Ideal for labs and industrial settings
- Assembles in minutes, no tools required
- Lockable doors open to 180°
- Doors can be assembled to open to the left or right
- 100 percent HDPE construction
- Adjustable shelves, 38 lbs. (17.3 kg.) per shelf (UDL)
- Sealed internal containment sump
- Two 2 inch (5.1 cm.) poly vents with caps
- 'Caution Corrosives' label included
- Modular linkage brackets included
- Additional color options on pg. 14-15



Space Saver Build
 in: 18W x 22D x 72H
 cm: 45.8W x 55.9D x 182.9H

Model M48CRA
 48-Gallon (181.7 L) Modular Cabinet
 in: 36W x 22D x 72H
 cm: 91.5W x 55.9D x 182.9H

Modular Designs

Model M12CRA
 12-Gallon (45.5 L)
 Modular Cabinet

Model M24CRA
 24-Gallon (90.9 L)
 Modular Cabinet

Under-the-Counter
 in: 36W x 22D x 36H
 cm: 91.5W x 55.9D x 91.5H



SAFETY CABINETS

MODULAR QUIK-ASSEMBLY™ POLY ACID & CORROSIVE SAFETY CABINETS



NEW COLORS



Capacity (Gal.)	15.2 L 4 gal.	45.5 L 12 gal.	90.9 L 24 gal.	90.9 L 24 gal.	181.7 L 48 gal.																																																												
Description	Bench Top	12-Gal. Modular	24-Gal. Modular (Space Saver)	24-Gal. Modular (Under-the-Counter)	48-Gal. Modular																																																												
Model Numbers	M04CRA M04CRAW	M12CRA M12CRAW	M24CRA M24CRAW	M24CRA M24CRAW	M48CRA M48CRAW																																																												
Outside Dimensions	<table border="1"> <tr><td>W:</td><td>cm.</td><td>in.</td></tr> <tr><td></td><td>45.8</td><td>18</td></tr> <tr><td>D:</td><td>45.8</td><td>18</td></tr> <tr><td>H:</td><td>55.9</td><td>22</td></tr> </table>	W:	cm.	in.		45.8	18	D:	45.8	18	H:	55.9	22	<table border="1"> <tr><td>W:</td><td>cm.</td><td>in.</td></tr> <tr><td></td><td>45.8</td><td>18</td></tr> <tr><td>D:</td><td>55.9</td><td>22</td></tr> <tr><td>H:</td><td>91.5</td><td>36</td></tr> </table>	W:	cm.	in.		45.8	18	D:	55.9	22	H:	91.5	36	<table border="1"> <tr><td>W:</td><td>cm.</td><td>in.</td></tr> <tr><td></td><td>45.8</td><td>18</td></tr> <tr><td>D:</td><td>55.9</td><td>22</td></tr> <tr><td>H:</td><td>182.9</td><td>72</td></tr> </table>	W:	cm.	in.		45.8	18	D:	55.9	22	H:	182.9	72	<table border="1"> <tr><td>W:</td><td>cm.</td><td>in.</td></tr> <tr><td></td><td>91.5</td><td>36</td></tr> <tr><td>D:</td><td>55.9</td><td>22</td></tr> <tr><td>H:</td><td>91.5</td><td>36</td></tr> </table>	W:	cm.	in.		91.5	36	D:	55.9	22	H:	91.5	36	<table border="1"> <tr><td>W:</td><td>cm.</td><td>in.</td></tr> <tr><td></td><td>91.5</td><td>36</td></tr> <tr><td>D:</td><td>55.9</td><td>22</td></tr> <tr><td>H:</td><td>182.9</td><td>72</td></tr> </table>	W:	cm.	in.		91.5	36	D:	55.9	22	H:	182.9	72
W:	cm.	in.																																																															
	45.8	18																																																															
D:	45.8	18																																																															
H:	55.9	22																																																															
W:	cm.	in.																																																															
	45.8	18																																																															
D:	55.9	22																																																															
H:	91.5	36																																																															
W:	cm.	in.																																																															
	45.8	18																																																															
D:	55.9	22																																																															
H:	182.9	72																																																															
W:	cm.	in.																																																															
	91.5	36																																																															
D:	55.9	22																																																															
H:	91.5	36																																																															
W:	cm.	in.																																																															
	91.5	36																																																															
D:	55.9	22																																																															
H:	182.9	72																																																															
Inside Dimensions	<table border="1"> <tr><td>W:</td><td>cm.</td><td>in.</td></tr> <tr><td></td><td>35.6</td><td>14</td></tr> <tr><td>D:</td><td>38.1</td><td>15</td></tr> <tr><td>H:</td><td>40</td><td>15½</td></tr> </table>	W:	cm.	in.		35.6	14	D:	38.1	15	H:	40	15½	<table border="1"> <tr><td>W:</td><td>cm.</td><td>in.</td></tr> <tr><td></td><td>35.6</td><td>14</td></tr> <tr><td>D:</td><td>48.3</td><td>19</td></tr> <tr><td>H:</td><td>75.6</td><td>29¾</td></tr> </table>	W:	cm.	in.		35.6	14	D:	48.3	19	H:	75.6	29¾	<table border="1"> <tr><td>W:</td><td>cm.</td><td>in.</td></tr> <tr><td></td><td>35.6</td><td>14</td></tr> <tr><td>D:</td><td>48.3</td><td>19</td></tr> <tr><td>H:</td><td>75.6</td><td>29¾</td></tr> </table>	W:	cm.	in.		35.6	14	D:	48.3	19	H:	75.6	29¾	<table border="1"> <tr><td>W:</td><td>cm.</td><td>in.</td></tr> <tr><td></td><td>35.6</td><td>14</td></tr> <tr><td>D:</td><td>48.3</td><td>19</td></tr> <tr><td>H:</td><td>75.6</td><td>29¾</td></tr> </table>	W:	cm.	in.		35.6	14	D:	48.3	19	H:	75.6	29¾	<table border="1"> <tr><td>W:</td><td>cm.</td><td>in.</td></tr> <tr><td></td><td>35.6</td><td>14</td></tr> <tr><td>D:</td><td>48.3</td><td>19</td></tr> <tr><td>H:</td><td>75.6</td><td>29¾</td></tr> </table>	W:	cm.	in.		35.6	14	D:	48.3	19	H:	75.6	29¾
W:	cm.	in.																																																															
	35.6	14																																																															
D:	38.1	15																																																															
H:	40	15½																																																															
W:	cm.	in.																																																															
	35.6	14																																																															
D:	48.3	19																																																															
H:	75.6	29¾																																																															
W:	cm.	in.																																																															
	35.6	14																																																															
D:	48.3	19																																																															
H:	75.6	29¾																																																															
W:	cm.	in.																																																															
	35.6	14																																																															
D:	48.3	19																																																															
H:	75.6	29¾																																																															
W:	cm.	in.																																																															
	35.6	14																																																															
D:	48.3	19																																																															
H:	75.6	29¾																																																															
No. of Shelves	2	2	4	4	8																																																												
Shelf Depth	38.8 cm./15 ¼ in.	48.9 cm./19 ¼ in.	48.9 cm./19 ¼ in.	48.9 cm./19 ¼ in.	48.9 cm./19 ¼ in.																																																												
Weight	14.6 kg./32 lbs.	20.5 kg./45 lbs.	40.9 kg./90 lbs.	40.9 kg./90 lbs.	81.7 kg./180 lbs.																																																												

Quik-Assembly™ in minutes
(No tools required)

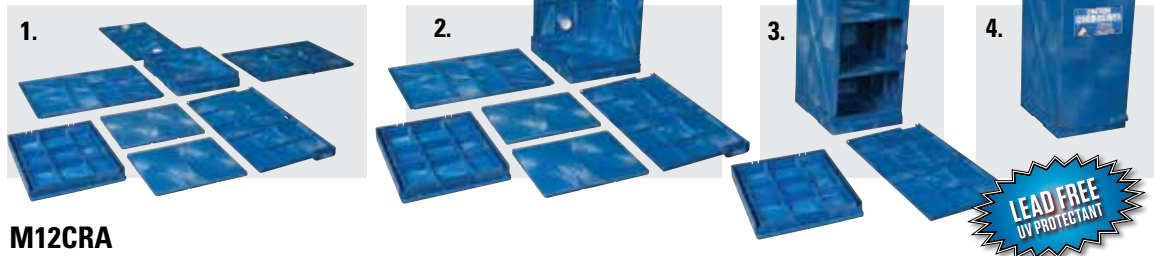

M12CRA
12-Gallon Modular





LEAD FREE
UV PROTECTANT



Capacity (Gal.)	15.2 L 4 gal.	15.2 L 4 gal.	45.5 L 12 gal.	45.5 L 12 gal.																																																
Description	Bench Top	Bench Top	12-Gal. Modular*	12-Gal. Modular*																																																
Model Numbers	M04Y M04BLK	M04BEI M04GRA	M12Y M12BLK	M12BEI M12GRA																																																
Outside Dimensions	<table border="1"> <tr><td>W:</td><td>cm.</td><td>in.</td></tr> <tr><td>D:</td><td>45.8</td><td>18</td></tr> <tr><td>H:</td><td>45.8</td><td>18</td></tr> <tr><td></td><td>55.9</td><td>22</td></tr> </table>	W:	cm.	in.	D:	45.8	18	H:	45.8	18		55.9	22	<table border="1"> <tr><td>W:</td><td>cm.</td><td>in.</td></tr> <tr><td>D:</td><td>45.8</td><td>18</td></tr> <tr><td>H:</td><td>45.8</td><td>18</td></tr> <tr><td></td><td>55.9</td><td>22</td></tr> </table>	W:	cm.	in.	D:	45.8	18	H:	45.8	18		55.9	22	<table border="1"> <tr><td>W:</td><td>cm.</td><td>in.</td></tr> <tr><td>D:</td><td>55.9</td><td>22</td></tr> <tr><td>H:</td><td>91.5</td><td>36</td></tr> </table>	W:	cm.	in.	D:	55.9	22	H:	91.5	36	<table border="1"> <tr><td>W:</td><td>cm.</td><td>in.</td></tr> <tr><td>D:</td><td>55.9</td><td>22</td></tr> <tr><td>H:</td><td>91.5</td><td>36</td></tr> </table>	W:	cm.	in.	D:	55.9	22	H:	91.5	36						
W:	cm.	in.																																																		
D:	45.8	18																																																		
H:	45.8	18																																																		
	55.9	22																																																		
W:	cm.	in.																																																		
D:	45.8	18																																																		
H:	45.8	18																																																		
	55.9	22																																																		
W:	cm.	in.																																																		
D:	55.9	22																																																		
H:	91.5	36																																																		
W:	cm.	in.																																																		
D:	55.9	22																																																		
H:	91.5	36																																																		
Inside Dimensions	<table border="1"> <tr><td>W:</td><td>cm.</td><td>in.</td></tr> <tr><td>D:</td><td>35.6</td><td>14</td></tr> <tr><td>H:</td><td>38.1</td><td>15</td></tr> <tr><td></td><td>40</td><td>15 1/4</td></tr> </table>	W:	cm.	in.	D:	35.6	14	H:	38.1	15		40	15 1/4	<table border="1"> <tr><td>W:</td><td>cm.</td><td>in.</td></tr> <tr><td>D:</td><td>35.6</td><td>14</td></tr> <tr><td>H:</td><td>38.1</td><td>15</td></tr> <tr><td></td><td>40</td><td>15 1/4</td></tr> </table>	W:	cm.	in.	D:	35.6	14	H:	38.1	15		40	15 1/4	<table border="1"> <tr><td>W:</td><td>cm.</td><td>in.</td></tr> <tr><td>D:</td><td>35.6</td><td>14</td></tr> <tr><td>H:</td><td>48.3</td><td>19</td></tr> <tr><td></td><td>75.6</td><td>29 1/2</td></tr> </table>	W:	cm.	in.	D:	35.6	14	H:	48.3	19		75.6	29 1/2	<table border="1"> <tr><td>W:</td><td>cm.</td><td>in.</td></tr> <tr><td>D:</td><td>35.6</td><td>14</td></tr> <tr><td>H:</td><td>48.3</td><td>19</td></tr> <tr><td></td><td>75.6</td><td>29 1/2</td></tr> </table>	W:	cm.	in.	D:	35.6	14	H:	48.3	19		75.6	29 1/2
W:	cm.	in.																																																		
D:	35.6	14																																																		
H:	38.1	15																																																		
	40	15 1/4																																																		
W:	cm.	in.																																																		
D:	35.6	14																																																		
H:	38.1	15																																																		
	40	15 1/4																																																		
W:	cm.	in.																																																		
D:	35.6	14																																																		
H:	48.3	19																																																		
	75.6	29 1/2																																																		
W:	cm.	in.																																																		
D:	35.6	14																																																		
H:	48.3	19																																																		
	75.6	29 1/2																																																		
No. of Shelves	2	2	2	2																																																
Shelf Depth	38.8 cm./15 1/4 in.	38.8 cm./15 1/4 in.	48.9 cm./19 1/4 in.	48.9 cm./19 1/4 in.																																																
Weight	14.6 kg./32 lbs.	14.6 kg./32 lbs.	20.5 kg./45 lbs.	20.5 kg./45 lbs.																																																



Quik-Assembly™

Available in beige, gray, black, yellow and blue.

NEW COLORS



SAFETY CABINETS

OFFICE SUPPLY CABINET



Capacity (Gal.)	21.5 cu. ft./ 0.6 cu. m.	
Common Name	Office Supply Cabinet	
Model Numbers	1947-4BE 1947-4GR	
Outside Dimensions	Width: 109.3 Depth: 45.8 Height: 165.1	cm. in. 44 18 65
Inside Dimensions	Width: 101.6 Depth: 38.1 Height: 157.5	cm. in. 40 15 62
No. of Shelves Extra Shelf Model No.	4 1915 BEIGE & 1915 GRAY	
Shelf Depth	37.5 cm./14 3/4 in.	
Maximum Weight	151 kg./334 lbs.	
Compliance	-	
Approvals	-	

NOTE:

Office Supply Cabinets require flammable labels to comply with NFPA Code 30.

Office Supply Cabinets:

- Provide secure, fire-resistant storage of software, financial records, supplies, toner, adhesives, etc.
- Have four painted shelves
- Are not fireproof

CABINET COMBOS

Safety Cabinet Combos!

Compliance solution combos for the handling & storage of flammable liquids

These combos bring you Eagle's best-selling Safety Cabinets filled with Eagle's market-leading 5-gallon (18.9 L) Type I Safety Cans with funnels! Now, one easy purchase can meet your compliance needs.



Capacity (Gal.)	113.6 L / 30 gal.	170.4 L / 45 gal.	227.2 L / 60 gal.
Common Name	30-Gallon Combo Cabinet	45-Gallon Combo Cabinet	60-Gallon Combo Cabinet
Model Numbers	(Includes 6 UI-50-FS Cans)	(Includes 9 UI-50-FS Cans)	(Includes 12 UI-50-FS Cans)
Door Styles	Manual Close: 1932SC6 Self Close: 3010SC6	1947SC9 4510SC9	1962SC12 6010SC12
Outside Dimensions	W: 109.3 D: 45.8 H: 111.8	cm. in. 43 18 44	W: 109.3 D: 45.8 H: 165.1
Inside Dimensions	W: 109.3 D: 38.1 H: 104.2	cm. in. 40 15 41	W: 79.4 D: 79.4 H: 165.1
No. of Shelves Extra Shelf Model No.	1 1915	2 1915	2 1911
Shelf Depth	37.5 cm. / 14 3/4 in.		71.2 cm. / 28 in.
Maximum Weight	123.9 kg. / 273 lbs.	170.1 kg. / 375 lbs.	198.3 kg. / 437 lbs.
Compliance			
Approvals			



CABINET ACCESSORIES

PLEASE CALL EAGLE CUSTOMER SERVICE AT 304.737.3171

Cabinet Accessories, Shelves & Parts SHELVES, POLY TRAYS, DOLLY CARTS & PARTS



3045 Kit Poly Trays
40 in. (104.6 cm.) x 16 in. (40.6 cm.) x 2.5 in. (6.4 cm.)



1915 Metal Shelves
39⁵/₈ in. (100.6 cm.) x 14¹/₄ in. (63.5 cm.) x 1 in. (2.54 cm.)



1950/1951 Bonding Wires (3 ft. / 91.5 cm.)
1953 Brass Horizontal Drum Vent
1974B Brass Faucet (3/4 in. / 1.90 cm.)



1794 Poly Drum Cabinet Ramp



1934 Cabinet Dolly Cart
with **1925**



1957 Galvanized Drum Cabinet Ramp
23.5 in. (59.7 cm.) x 26.25 in. (66.7 cm.)



1934 & 1935 Cabinet Dolly Carts



1918 Horizontal Drum Cradle



1916G Shelf Dividers



1910G Self-Closing Adaptor Kit



1936 Cabinet Earthquake Kit



1933 Cabinet Wheel Kit
(Fits 30 gal. / 113.6 L and smaller)



1920 Roller Conveyors
Two Shown (Sold Individually)

1993G	Self-Closing Adaptor Kit for 1946 & 4610
CRA-1900	Poly Bottom Tray for 2- & 4-gallon cabinets
CRA-1901	Poly Tray for 2- & 4-gallon cabinets
CRA-1902	Coated Metal Shelf for 2- & 4-gallon cabinets
CRA-1907	Poly Bottom Tray for 12-, 16- & 24-gallon cabinets
CRA-1908	Poly Shelf Tray for 12-, 16- & 24-gallon cabinets
CRA-1909	Coated Metal Shelf for 12-, 16- & 24-gallon cabinets
CRA-1912	Poly Bottom Tray for 15-, 30- & 45-gallon cabinets
CRA-1913	Poly Shelf Tray for 15-, 30- & 45-gallon cabinets
CRA-1914	Coated Metal Shelf for 15-, 30- & 45-gallon cabinets
CRA-1916	Poly Bottom Tray for 60-gallon cabinets
CRA-1917	Poly Shelf Tray for 60-gallon cabinets
CRA-1918	Coated Metal Shelf for 60-gallon cabinets
CRA-72	Coated Metal Shelf for CRA-70 & CRA-71
CRA-73	Poly Bottom Tray for CRA-70 & CRA-71
CRA-74	Poly Shelf Tray for CRA-70 & CRA-71
CRA-PS04	Poly Cabinet Shelf for 4-gallon poly cabinet
CRA-PS22	Poly Cabinet Shelf for 22- & 44-gallon poly cabinets
3045 Kit	Universal Poly Tray Kit 3 trays
C79HC	Hydraulic Closer
C79S	Short Cylinder
C-80	Fusible Link Round Sliding Door Models Only
C-80N	Fusible Link Rectangular 1 & 2 Door Self-Closing Models
C-82N	Lever Handle Door Lock with Keys (non-button latch)
C-83N	Key Set (2 keys) (Key #CH751)
C-82BL	Lever Handle Door Lock with Keys (button latch)
C-82PL	Paddle Latch Door Lock with Keys (flush mount)
C88	Lock Plate Cover
C-891BL	Door Lock Assembly 30-32 Gallon Button Latch Cabinet
C-892BL	Door Lock Assembly 45-47 Gallon Button Latch Cabinet
C-891PL	Door Lock Assembly 30-32 Gallon Paddle Lock
C-892PL	Door Lock Assembly 45-47 Gallon Paddle Lock
1902	Metal Shelf for 2- and 4-gallon cabinets
1908G	3 in. Divider for 60-gallon cabinets
1909G	5 in. Divider for 60-gallon cabinets
1910G	Self-Closing Adaptor Kit for 15-, 30-, 45-, 90-gallon & Wall Mount cabinets
1911	Metal Shelf for 60-gallon cabinets
1912G	Self-Closing Kit for All Single Door 4-, 12-, 16- and 24-gallon cabinets
1915	Metal Shelf for 15-, 30- & 45-gallon cabinets
1916G	3in. Divider for 4-, 12-, 15-, 16-, 30-, 45-gallon cabinets
1917G	5in. Divider for 4-, 12-, 15-, 16-, 30-, 45-gallon cabinets
1918	Cradle for Horizontal Drum Cabinets
1919	Metal Shelf for 12-, 16- & 24-gallon cabinets
1920	2 in. Roller Conveyor HAZ1926 & HAZ1955
1921	Metal Shelf for HAZ1926 & HAZ2610
1922	Metal Shelf for HAZ1955
1933	Cabinet Wheel Kit for 30-gallon or less
1934	Cabinet Dolly Cart for 12- & 16-gallon cabinets
1935	Cabinet Dolly Cart for 15- & 30-gallon cabinets
1936	Cabinet Earthquake Kit all cabinets
1950	Grounding Wire w/Alligator Clips 36 in. length
1951	Bonding Wire w/C Clip 36 in. length
1953	Brass Horizontal Drum Vent
1957	Galvanized Drum Cabinet Ramp
1794	Poly Ramp for use with Vertical Drum Cabinets
1966G	Self-Closing Adaptor Kit for 60-Gallon Flammable, PI 60 Series & Vertical One Drum Cabinet
1967G	Self-Closing Adaptor Kit for 2 Drum Cabinet
1968G	Self-Closing Adaptor Kit for 1961 & 6110
1972	Metal Shelf for Under Counter Cabinets
1974B	Brass Faucet
1994	2 in. Roller Conveyor HAZ1992 & HAZ9010
1977	Metal Shelf for PI-77 Wall Mount Cabinets
1978G	Self-Closing Adaptor Kit for Under Counter Cabinets
1979GN	Self-Closing Adaptor Kit for HAZ9010



SAFETY CANS

For nearly 60 years, our Safety Can product line has been an industry leader of galvanized Type I and Type II Safety Cans that meet OSHA and NFPA Code 30 requirements, and are UL and ULC listed and FM Approved for safe storage and handling of flammable liquids. Eagle offers FM Approved Compliance Solutions in a variety of poly and stainless cans, lab cans, faucet cans, disposal cans, plunger, bench & daub cans, and poly oily waste cans to help keep your personnel and facilities protected. Made in the USA.

Safety Can options:

- Type I Safety Cans
- Type II Safety Cans
- Type I Poly Cans
- Stainless Cans
- Lab Cans
- Faucet Cans
- DOT Cans
- Disposal Cans
- Specialty Cans
- Plunger Cans
- Bench Cans
- Daub Cans
- Poly Oily Waste Cans
- Biohazardous Cans



Patented comfort grip trigger release plus spring closing lid with nitrile gasket that vents at 5-PSI internal pressure



Double interlock no-weld bottom seam is the only deep drawn seamless can made

SAFETY CANS



SIMPLY CANTASTIC!

Baked-on Powder Coat Finish + 100 Percent Leak Tested!

Featuring Environmentally Friendly Hot Dipped 24-Gauge Galvanized Steel

Patented Comfort Grip Trigger Release

Spring Closing Lid With Nitrile Gasket That Vents at 5-PSI Internal Pressure

Fixed Handle

Non-Sparking Flame Arrestor and Pour Spout

Baked-on Powder Coat Finish

Available in 1- (3.8 L), 2- (7.6 L), 2.5- (9.5 L) & 5-Gallon (18.9 L) Sizes

Meet OSHA & NFPA Code 30 Requirements

FM, UL & ULC Approved

Accepted Under CARB

Double Interlock No-Weld Bottom Seam

Optional F-15 HDPE Funnel Fits Unleaded Fuel Tanks

The Only Deep Drawn Seamless Can Made

Deep Drawn Construction Means No Top or Side Seam

Trilingual Label



Model UI-50-FS 12½ in. (31.8 cm.) x 13½ in. (34.3 cm.)



FLAMMABLE



DIESEL



KEROSENE

SAFETY CANS

TYPE I SAFETY CANS

FLAMMABLES



Model Numbers	UI-4-S	UI-10-S	UI-20-S	UI-25-S*	UI-50-S
Model-w/Funnel	UI-4-FS	UI-10-FS	UI-20-FS	UI-25-FS*	UI-50-FS
Capacity	2 qt./2 L	1 gal./3.8 L	2 gal./7.6 L	2½ gal./9.5 L	5 gal./18.9 L
Dimensions <small>Diameter Height</small>	9 in./22.9 cm. 5⅝ in./13.5 cm.	9 in./22.9 cm. 8 in./20.4 cm.	11¼ in./28.6 cm. 9½ in./24.2 cm.	11¼ in./28.6 cm. 10 in./25.4 cm.	12½ in./31.8 cm. 13⅜ in./34.3 cm.
Weight	2.25 lbs./1.1 kg.	3.52 lbs./1.6 kg.	5.25 lbs./2.4 kg.	5.7 lbs./2.6 kg.	7 lbs./3.2 kg.
Construction	Galvanized	Galvanized	Galvanized	Galvanized	Galvanized

TYPE I SAFETY CANS

DIESEL



Model Numbers	UI-4-SY	UI-10-SY	UI-20-SY	UI-25-SY*	UI-50-SY
Model-w/Funnel	UI-4-FSY	UI-10-FSY	UI-20-FSY	UI-25-FSY*	UI-50-FSY
Capacity	2 qt./2 L	1 gal./3.8 L	2 gal./7.6 L	2½ gal./9.5 L	5 gal./18.9 L
Dimensions <small>Diameter Height</small>	9 in./22.9 cm. 5⅝ in./13.5 cm.	9 in./22.9 cm. 8 in./20.4 cm.	11¼ in./28.6 cm. 9½ in./24.2 cm.	11¼ in./28.6 cm. 10 in./25.4 cm.	12½ in./31.8 cm. 13⅜ in./34.3 cm.
Weight	2.25 lbs./1.1 kg.	3.52 lbs./1.6 kg.	5.25 lbs./2.4 kg.	5.7 lbs./2.6 kg.	7 lbs./3.2 kg.
Construction	Galvanized	Galvanized	Galvanized	Galvanized	Galvanized

Type I Safety Cans

- Eagle Type 1 Safety Cans are constructed of 24-gauge hot dipped galvanized steel, whereas other manufacturers' safety cans use lead-coated terne steel
- These safety cans are accepted under CARB, meet OSHA and NFPA Code 30 requirements, and are UL, ULC and FM Approved for safe handling and storage of gasoline and other flammable liquids
- Available in a variety of colors for the safe handling and storage of kerosene (blue), diesel (yellow) and combustible liquids such as oils (green)

* Meets the New York City Fire Code Title 29 FC 2204.4.4.1.1 Maximum 2.5 gallon (9.5 L) container regulations

Compliance: OSHA 29 CFR 1910.106, 1926.152 and NFPA Code 30





TYPE I SAFETY CANS



Model Numbers	UI-4-SB	UI-10-SB	UI-20-SB	UI-25-SB*	UI-50-SB
Model-w/Funnel	UI-4-FSB	UI-10-FSB	UI-20-FSB	UI-25-FSB*	UI-50-FSB
Capacity	2 qt./2 L	1 gal./3.8 L	2 gal./7.6 L	2½ gal./9.5 L	5 gal./18.9 L
Dimensions	9 in./22.9 cm. 5⅝ in./13.5 cm.	9 in./22.9 cm. 8 in./20.4 cm.	11¼ in./28.6 cm. 9½ in./24.2 cm.	11¼ in./28.6 cm. 10 in./25.4 cm.	12½ in./31.8 cm. 13⅜ in./34.3 cm.
Weight	2.25 lbs./1.1 kg.	3.52 lbs./1.6 kg.	5.25 lbs./2.4 kg.	5.7 lbs./2.6 kg.	7 lbs./3.2 kg.
Construction	Galvanized	Galvanized	Galvanized	Galvanized	Galvanized

Model Numbers	UI-4-SB	UI-10-SB	UI-20-SB	UI-25-SB*	UI-50-SB
Model-w/Funnel	UI-4-FSB	UI-10-FSB	UI-20-FSB	UI-25-FSB*	UI-50-FSB
Capacity	2 qt./2 L	1 gal./3.8 L	2 gal./7.6 L	2½ gal./9.5 L	5 gal./18.9 L
Dimensions	9 in./22.9 cm. 5⅝ in./13.5 cm.	9 in./22.9 cm. 8 in./20.4 cm.	11¼ in./28.6 cm. 9½ in./24.2 cm.	11¼ in./28.6 cm. 10 in./25.4 cm.	12½ in./31.8 cm. 13⅜ in./34.3 cm.
Weight	2.25 lbs./1.1 kg.	3.52 lbs./1.6 kg.	5.25 lbs./2.4 kg.	5.7 lbs./2.6 kg.	7 lbs./3.2 kg.
Construction	Galvanized	Galvanized	Galvanized	Galvanized	Galvanized

TYPE I SAFETY CANS



Model Numbers	UI-4-SG	UI-10-SG	UI-20-SG	UI-25-SG*	UI-50-SG
Model-w/Funnel	UI-4-FSG	UI-10-FSG	UI-20-FSG	UI-25-FSG*	UI-50-FSG
Capacity	2 qt./2 L	1 gal./3.8 L	2 gal./7.6 L	2½ gal./9.5 L	5 gal./18.9 L
Dimensions	9 in./22.9 cm. 5⅝ in./13.5 cm.	9 in./22.9 cm. 8 in./20.4 cm.	11¼ in./28.6 cm. 9½ in./24.2 cm.	11¼ in./28.6 cm. 10 in./25.4 cm.	12½ in./31.8 cm. 13⅜ in./34.3 cm.
Weight	2.25 lbs./1.1 kg.	3.52 lbs./1.6 kg.	5.25 lbs./2.4 kg.	5.7 lbs./2.6 kg.	7 lbs./3.2 kg.
Construction	Galvanized	Galvanized	Galvanized	Galvanized	Galvanized

Model Numbers	UI-4-SG	UI-10-SG	UI-20-SG	UI-25-SG*	UI-50-SG
Model-w/Funnel	UI-4-FSG	UI-10-FSG	UI-20-FSG	UI-25-FSG*	UI-50-FSG
Capacity	2 qt./2 L	1 gal./3.8 L	2 gal./7.6 L	2½ gal./9.5 L	5 gal./18.9 L
Dimensions	9 in./22.9 cm. 5⅝ in./13.5 cm.	9 in./22.9 cm. 8 in./20.4 cm.	11¼ in./28.6 cm. 9½ in./24.2 cm.	11¼ in./28.6 cm. 10 in./25.4 cm.	12½ in./31.8 cm. 13⅜ in./34.3 cm.
Weight	2.25 lbs./1.1 kg.	3.52 lbs./1.6 kg.	5.25 lbs./2.4 kg.	5.7 lbs./2.6 kg.	7 lbs./3.2 kg.
Construction	Galvanized	Galvanized	Galvanized	Galvanized	Galvanized

TYPE I POLY CANS

TYPE I STAINLESS STEEL CANS











Model Numbers	1535	1541	1537	1543	1533	1539	1313	1315
Capacity	3 gal./11.4 L	5 gal./19 L	3 gal./11.4 L	5 gal./19 L	3 gal./11.4 L	5 gal./19 L	2½ gal./9.5 L	5 gal./19 L
Dimensions	12½ in./31.8 cm. 13 in./33.1 cm.	12½ in./31.8 cm. 17 in./43.2 cm.	12½ in./31.8 cm. 13 in./33.1 cm.	12½ in./31.8 cm. 17 in./43.2 cm.	12½ in./31.8 cm. 13 in./33.1 cm.	12½ in./31.8 cm. 17 in./43.2 cm.	11¼ in./28.6 cm. 9 in./24.5 cm.	11¼ in./28.6 cm. 15 in./39.7 cm.
Weight	6 lbs./2.8 kg.	7 lbs./3.2 kg.	6 lbs./2.8 kg.	7 lbs./3.2 kg.	6 lbs./2.8 kg.	7 lbs./3.2 kg.	8 lbs./3.7 kg.	10 lbs./4.6 kg.
Construction	Poly	Poly	Poly	Poly	Poly	Poly	Stainless	Stainless

Model Numbers	1535	1541	1537	1543	1533	1539	1313	1315
Capacity	3 gal./11.4 L	5 gal./19 L	3 gal./11.4 L	5 gal./19 L	3 gal./11.4 L	5 gal./19 L	2½ gal./9.5 L	5 gal./19 L
Dimensions	12½ in./31.8 cm. 13 in./33.1 cm.	12½ in./31.8 cm. 17 in./43.2 cm.	12½ in./31.8 cm. 13 in./33.1 cm.	12½ in./31.8 cm. 17 in./43.2 cm.	12½ in./31.8 cm. 13 in./33.1 cm.	12½ in./31.8 cm. 17 in./43.2 cm.	11¼ in./28.6 cm. 9 in./24.5 cm.	11¼ in./28.6 cm. 15 in./39.7 cm.
Weight	6 lbs./2.8 kg.	7 lbs./3.2 kg.	6 lbs./2.8 kg.	7 lbs./3.2 kg.	6 lbs./2.8 kg.	7 lbs./3.2 kg.	8 lbs./3.7 kg.	10 lbs./4.6 kg.
Construction	Poly	Poly	Poly	Poly	Poly	Poly	Stainless	Stainless





SAFETY CANS

TYPE II SAFETY CANS



	FLAMMABLES		KEROSENE		DIESEL		COMBUSTIBLES	
								
Model 7/8" Spout	U2-26-S	U2-51-S	U2-26-SB	U2-51-SB	U2-26-SY	U2-51-SY	U2-26-SG	U2-51-SG
Model 5/8" Spout	U2-26-SX5	U2-51-SX5	U2-26-SX5B	U2-51-SX5B	U2-26-SX5Y	U2-51-SX5Y	U2-26-SX5G	U2-51-SX5G
Capacity	2½ gal./9.5 L	5 gal./19 L	2½ gal./9.5 L	5 gal./19 L	2½ gal./9.5 L	5 gal./19 L	2½ gal./9.5 L	5 gal./19 L
Dimensions <small>Diameter Height</small>	11¼ in./28.6 cm. 9½ in./24.2 cm.	12½ in./31.8 cm. 15 in./40.4 cm.	11¼ in./28.6 cm. 9½ in./24.2 cm.	12½ in./31.8 cm. 15 in./40.4 cm.	11¼ in./28.6 cm. 9½ in./24.2 cm.	12½ in./31.8 cm. 15 in./40.4 cm.	11¼ in./28.6 cm. 9½ in./24.2 cm.	12½ in./31.8 cm. 15 in./40.4 cm.
Weight	8 lbs./3.7 kg.	10 lbs./4.6 kg.	8 lbs./3.7 kg.	10 lbs./4.6 kg.	8 lbs./3.7 kg.	10 lbs./4.6 kg.	8 lbs./3.7 kg.	10 lbs./4.6 kg.
Construction	Galvanized	Galvanized	Galvanized	Galvanized	Galvanized	Galvanized	Galvanized	Galvanized



				
Model 7/8" Spout	U2-11-S	U2-11-SB	U2-11-SY	U2-11-SG
Model 5/8" Spout	U2-11-SX5	U2-11-SX5B	U2-11-SX5Y	U2-11-SX5G
Capacity	1 gal./3.8 L	1 gal./3.8 L	1 gal./3.8 L	1 gal./3.8 L
Dimensions <small>Diameter Height</small>	11¼ in./28.6 cm. 7¼ in./18.4 cm.	11¼ in./28.6 cm. 7¼ in./18.4 cm.	11¼ in./28.6 cm. 7¼ in./18.4 cm.	11¼ in./28.6 cm. 7¼ in./18.4 cm.
Weight	7 lbs./3.2 kg.	7 lbs./3.2 kg.	7 lbs./3.2 kg.	7 lbs./3.2 kg.
Construction	Galvanized	Galvanized	Galvanized	Galvanized



- Eagle Type II Safety Cans are made of galvanized steel and help reduce the danger of explosion while dispensing flammable liquids through a flexible 12 in. (30.5 cm.) metal spout
- Flame arrestors in filler opening and pour spout

Compliance: OSHA 29 CFR 1910.106, 1926.152 and NFPA Code 30

















- Metal Safety Cans are FM, UL and ULC Approved and meet OSHA and NFPA Code 30 requirements. Poly Cans are FM Approved.













LAB CANS

	STAINLESS	POLY					
							
Model Numbers	1301	1512	1513	1510	1511	1508	1509
Approvals							
Capacity	1 gal./3.8 L	½ gal./1.9 L	1 gal./3.8 L	½ gal./1.9 L	1 gal./3.8 L	½ gal./1.9 L	1 gal./3.8 L
Dimensions Width Depth Height	4¼ in./10.8 cm. 8 in./20.4 cm. 13 in./33.1 cm.	6 in./15.3 cm. 8½ in./21.6 cm. 9½ in./24.2 cm.	6 in./15.3 cm. 8½ in./21.6 cm. 13 in./33.1 cm.	6 in./15.3 cm. 8½ in./21.6 cm. 9½ in./24.2 cm.	6 in./15.3 cm. 8½ in./21.6 cm. 13 in./33.1 cm.	6 in./15.3 cm. 8½ in./21.6 cm. 9½ in./24.2 cm.	6 in./15.3 cm. 8½ in./21.6 cm. 13 in./33.1 cm.
Weight	3.75 lbs./1.7 kg.	2.5 lbs./1.2 kg.	2.8 lbs./1.3 kg.	2.5 lbs./1.2 kg.	2.8 lbs./1.3 kg.	2.5 lbs./1.2 kg.	2.8 lbs./1.3 kg.
Construction	Stainless	Poly	Poly	Poly	Poly	Poly	Poly

FAUCET CANS

DOT CANS

	FAUCET CANS			DOT CANS		
						
Model Numbers	1417	1327	1215	1215-SX5	1215Y	1215Y-SX5
Approvals			—	—	—	—
Capacity	5 gal./19 L	5 gal./19 L	5 gal./19 L	5 gal./19 L	5 gal./19 L	5 gal./19 L
Dimensions Diameter Height	12½ in./31.8 cm. 13½ in./34.3 cm.	11¼ in./28.6 cm. 15½ in./40.4 cm.	12½ in./31.8 cm. 15¾ in./40 cm.	12½ in./31.8 cm. 15¾ in./40 cm.	12½ in./31.8 cm. 15¾ in./40 cm.	12½ in./31.8 cm. 15¾ in./40 cm.
Weight	12 lbs./5.5 kg.	9 lbs./4.1 kg.	13 lbs./5.9 kg.	13 lbs./5.9 kg.	13 lbs./5.9 kg.	13 lbs./5.9 kg.
Construction	Galvanized	Stainless	Galvanized	Galvanized	Galvanized	Galvanized

Laboratory Safety Cans:

- Laboratory Safety Cans reduce the danger of explosions resulting from the ignition of vapors of flammable liquids
- Cans are available in coated metal, stainless steel and high-density polyethylene for safe storage and handling of most chemical compounds

Compliance: OSHA 29 CFR 1910.106, 1925.152 & NFPA Code 30

DOT Transport Type II Safety Cans:

- Reduce the danger of explosion while dispensing flammable liquids through a flexible metal spout
- Have double-walled flame arrestors in filler opening and pour spout
- Heavy duty roll bars protect both spouts, and a thumb screw mechanism assures the filler opening stays closed while being transported
- Meet DOT requirements

Compliance: OSHA 29 CFR 1910.106, 1925.152 & NFPA Code 30 - UN/DOT-1A1/Y1.2/100/08/USA/M4990/0.6mm

SAFETY CANS

DISPOSAL CANS



Model Numbers	1519	1525	1517	1523	1515	1521
Approvals						
Capacity	3 gal./11.4 L	5 gal./19 L	3 gal./11.4 L	5 gal./19 L	3 gal./11.4 L	5 gal./19 L
Dimensions <small>Diameter Height</small>	12½ in./31.8 cm. 14½ in./36.9 cm.	12½ in./31.8 cm. 18½ in./47 cm.	12½ in./31.8 cm. 14½ in./36.9 cm.	12½ in./31.8 cm. 18½ in./47 cm.	12½ in./31.8 cm. 14½ in./36.9 cm.	12½ in./31.8 cm. 18½ in./47 cm.
Weight	7 lbs./3.2 kg.	8 lbs./3.7 kg.	7 lbs./3.2 kg.	8 lbs./3.7 kg.	7 lbs./3.2 kg.	8 lbs./3.7 kg.
Construction	Poly	Poly	Poly	Poly	Poly	Poly

DISPOSAL CANS

SPECIAL CANS



Model Numbers	1423	1425	1323	1325	605	211
Approvals					Lift Oil Can	Tallow Pot
Capacity	2½ gal./9.5 L	5 gal./19 L	2½ gal./9.5 L	5 gal./19 L	5 gal./19 L	4 pt./3.4 L
Dimensions <small>Diameter Height</small>	11¼ in./28.6 cm. 12 in./30.5 cm.	11¼ in./28.6 cm. 18 in./45.8 cm.	11¼ in./28.6 cm. 12 in./30.5 cm.	11¼ in./28.6 cm. 18 in./45.8 cm.	11¼ in./28.6 cm. 38 in./96.6 cm.	5¼ in./13.3 cm. 7½ in./19 cm.
Weight	8 lbs./3.7 kg.	10 lbs./4.6 kg.	8 lbs./3.7 kg.	10 lbs./4.6 kg.	10 lbs./4.6 kg.	2 lbs./0.9 kg.
Construction	Galvanized	Galvanized	Stainless	Stainless	Galvanized	Coated Metal

Metal & Polyethylene Disposal Safety Cans:

- Disposal Safety Cans provide an intermediate station for temporary storage of liquid wastes
- Spout cap opens to a wide 80° angle and can be locked open for conveniently emptying various types of containers
- Cans are equipped with a flame arrestor
- Cap assembly opens automatically to relieve excessive internal vapor pressures
- FM Approved





PLUNGER CANS



	METAL			POLY		
Model Numbers	P-701	P-702	P-704	P-711	P-712	P-714
Approvals						
Capacity	1 qt./1 L	2 qt./1.9 L	4 qt./3.8 L	1 qt./1 L	2 qt./1.9 L	4 qt./3.8 L
Dimensions <small>Diameter Height</small>	6 1/4 in./15.9 cm. 8 in./20.4 cm.	8 in./20.4 cm. 8 1/2 in./21.6 cm.	8 in./20.4 cm. 10 1/4 in./27.3 cm.	5 1/4 in./13.4 cm. 9 3/4 in./24.8 cm.	6 1/2 in./16.6 cm. 11 in./28 cm.	7 1/4 in./19.7 cm. 13 in./33 cm.
Weight	2.34 lbs./1.1 kg.	3 lbs./1.4 kg.	3.67 lbs./1.7 kg.	2 lbs./0.9 kg.	3 lbs./1.4 kg.	4 lbs./1.9 kg.
Construction	Galvanized	Galvanized	Galvanized	Poly	Poly	Poly

BENCH & DAUB CANS



	DAUB			BENCH			
Model Numbers	B-600-D	B-601	B-602	B-604	B-606	B-606-NL	B-608
Approvals							
Capacity	1/2 pt./0.2 L	1 qt./1 L	2 qt./1.9 L	4 qt./3.8 L	6 qt./5.7 L	6 qt./5.7 L	8 qt./7.6 L
Dimensions <small>Diameter Height</small>	4 1/4 in./10.8 cm. 3 1/2 in./8.9 cm.	6 1/4 in./15.9 cm. 3 3/4 in./9.2 cm.	8 in./20.4 cm. 4 1/4 in./10.8 cm.	8 in./20.4 cm. 6 1/2 in./16.6 cm.	7 1/4 in./19.7 cm. 9 1/2 in./24.2 cm.	7 1/4 in./19.7 cm. 9 1/2 in./24.2 cm.	11 1/4 in./28.6 cm. 7 in./17.8 cm.
Weight	1 lb./0.5 kg.	2.17 lbs./1 kg.	3 lbs./1.4 kg.	3.5 lbs./1.6 kg.	3.67 lbs./1.7 kg.	3.67 lbs./1.7 kg.	8.25 lbs./3.8 kg.
Construction	Galvanized	Galvanized	Galvanized	Galvanized	Galvanized	Galvanized	Galvanized

Optional cleaning basket shown is available for both models















Plunger & Bench Safety Cans:

- Eagle Safety Plunger Cans are ideal for cleaning with flammable or volatile fluids
- Feature brass flame arrestor dasher screens and pump assemblies and comply with OSHA standards
- When the dasher plate is pushed down, the safety can dispenses a small amount of liquid to easily moisten sponges or rags without messy or dangerous spills
- Polyethylene and coated metal models available
- FM Approved
- Eagle Safety Bench Cans are designed for safer cleaning of small parts or swabbing of larger ones
- Dasher screens act as a fire baffle

SAFETY CANS

POLY WASTE CANS

						
Model Numbers	933-FL	935-FL	937-FL	933-FLY	935-FLY	937-FLY
Approvals						
Capacity	6 gal./22.8 L	10 gal./37.9 L	14 gal./53 L	6 gal./22.8 L	10 gal./37.9 L	14 gal./53 L
Dimensions	Width 16½ in./42 cm. Depth 13½ in./34.3 cm. Height 16 in./40.7 cm.	22 in./55.9 cm. 18 in./45.8 cm. 18 in./45.8 cm.	22 in./55.9 cm. 18 in./45.8 cm. 21 in./53.4 cm.	16½ in./42 cm. 13½ in./34.3 cm. 16 in./40.7 cm.	22 in./55.9 cm. 18 in./45.8 cm. 18 in./45.8 cm.	22 in./55.9 cm. 18 in./45.8 cm. 21 in./53.4 cm.
Weight	9 lbs./4.1 kg.	14 lbs./6.4 kg.	16 lbs./7.3 kg.	9 lbs./4.1 kg.	14 lbs./6.4 kg.	16 lbs./7.3 kg.

POLY WASTE CANS

BIOHAZARDOUS POLY WASTE CANS

						
Model Numbers	933-FLBK	935-FLBK	937-FLBK	943BIO	945BIO	947BIO
Approvals						
Capacity	6 gal./22.8 L	10 gal./37.9 L	14 gal./53 L	6 gal./22.8 L	10 gal./37.9 L	14 gal./53 L
Dimensions	Width 16½ in./42 cm. Depth 13½ in./34.3 cm. Height 16 in./40.7 cm.	22 in./55.9 cm. 18 in./45.8 cm. 18 in./45.8 cm.	22 in./55.9 cm. 18 in./45.8 cm. 21 in./53.4 cm.	16½ in./42 cm. 13½ in./34.3 cm. 16 in./40.7 cm.	22 in./55.9 cm. 18 in./45.8 cm. 18 in./45.8 cm.	22 in./55.9 cm. 18 in./45.8 cm. 21 in./53.4 cm.
Weight	9 lbs./4.1 kg.	14 lbs./6.4 kg.	16 lbs./7.3 kg.	9 lbs./4.1 kg.	14 lbs./6.4 kg.	16 lbs./7.3 kg.

Polyethylene Oily Waste Cans:

- Fire-safe temporary storage of solvent rags, waste rags, shavings and other materials

Compliance: OSHA 29 CFR 1910.125(e)(4)(ii) and OSHA 29 CFR 1910.125(e)(4)(iii)

Polyethylene Biohazardous Waste Cans:

- Advise workers of potential biohazards and meet OSHA requirements for exposures to blood borne pathogens

Compliance: OSHA 29 CFR 1910.1030

Can be used with or without a liner

Fire-safe temporary storage of solvent rags, waste rags, shavings and other materials subject to spontaneous combustion

Polyethylene construction won't rust or dent and is resistant to most chemical compounds – heavy-wall HDPE construction

Meets OSHA and NFPA Code 30 requirements and are accepted for temporary storage of oily waste materials

Flared base for added stability



Self-closing lid

Molded handles for easy handling

No seam, leakproof construction

Exceeds FM standards for impact, stability & fire testing

Exceeds performance standards at temperatures between -40° F (4.4° C) & 140° F (54.4° C)

Hands-free foot lever



SAFESMOKER™ & Butt Cans

SafeSmoker™ Cigarette Receptacle is made of high-density polyethylene with UV inhibitors, with a galvanized steel collection bucket inside. Design restricts oxygen to quickly extinguish burning butts. Top of container removes easily to access and empty internal bucket. Rain-protective design keeps water out and eliminates odor. Includes integrated hold-down tabs for security and wind protection.

Eagle Butt Cans are ideal for “designated smoking areas” inside or outside. Features poly tube and galvanized can base. Yellow for in-plant use and beige for office or commercial areas.

Original Butt Cans This all-metal galvanized steel can is excellent for smoking areas in industrial settings. 5-gallon (18.9 L) capacity in yellow or beige.



Model	Description	SafeSmoker™ Cigarette Receptacle Dimensions (dia. x height)	Capacity	Weight
1208BEIGE	SafeSmoker™-Beige	in: 17¼ x 43¼ cm: 43.8 x 109.9	4 gal./15.2 L	10 lbs./4.5 kg.
1208BROWN	SafeSmoker™-Brown	in: 17¼ x 43¼ cm: 43.8 x 109.9	4 gal./15.2 L	10 lbs./4.5 kg.
1208GRAY	SafeSmoker™-Gray	in: 17¼ x 43¼ cm: 43.8 x 109.9	4 gal./15.2 L	10 lbs./4.5 kg.
1208BLACK	SafeSmoker™-Black	in: 17¼ x 43¼ cm: 43.8 x 109.9	4 gal./15.2 L	10 lbs./4.5 kg.
1206BEIGE	SafeSmoker™-Beige	in: 15¼ x 37¼ cm: 38.8 x 95.9	5 qt./4.7 L	7 lbs./3.2 kg.
1206BROWN	SafeSmoker™-Brown	in: 15¼ x 37¼ cm: 38.8 x 95.9	5 qt./4.7 L	7 lbs./3.2 kg.
1206GRAY	SafeSmoker™-Gray	in: 15¼ x 37¼ cm: 38.8 x 95.9	5 qt./4.7 L	7 lbs./3.2 kg.
1206BLACK	SafeSmoker™-Black	in: 15¼ x 37¼ cm: 38.8 x 95.9	5 qt./4.7 L	7 lbs./3.2 kg.

Capacity	Dimensions	Metal/Poly Butt Cans			Weight
		Yellow	Beige	Black	
2 gal./7.58 L	in: 11 x 35 cm: 27.9 x 88.9	1202	1202BEI	1202BLK	5 lbs./2.3 kg.
5 gal./18.9 L	in: 12 x 40 cm: 30.5 x 101.6	1205	1205BEI	1205BLK	7 lbs./3.2 kg.

Capacity	Dimensions	Original Butt Can		Weight
		Yellow	Beige	
5 gal./18.9 L	in: 12 x 33 cm: 30.5 x 83.8	1200YELLOW	1200BEIGE	7 lbs./3.2 kg.

Model	Description	Decorative SafeSmoker™		Capacity	Weight
		Dimensions			
1212BLACK	SafeSmoker™-Hitching Post	in: 12½ x 44¼ cm: 31.8 x 111.8		2 gal./7.58 L	18 lbs./8.2 kg.
1213BLACK	SafeSmoker™-Classic	in: 12½ x 37 cm: 31.8 x 94		2 gal./7.58 L	18 lbs./8.2 kg.

SHIPPING SIZES:

	L x W x H
1200	in: 13 x 13 x 20 cm: 33.1 x 33.1 x 50.8
1202	in: 13 x 13 x 28 cm: 33.1 x 33.1 x 71.2
1205	in: 13 x 13 x 28 cm: 33.1 x 33.1 x 71.2
1206	in: 16 x 16 x 21 cm: 40.7 x 40.7 x 53.4
1208	in: 17½ x 17½ x 25 cm: 44.5 x 44.5 x 63.5

All are shipped UPS.

All cans are FM Approved.

Container top removes easily to empty internal galvanized steel bucket.





SPILL CONTAINMENT

Since the 1980s, Eagle Manufacturing has had the most flexible and comprehensive spill containment and storage product line available. As the market leader, we have trusted Compliance Solutions to help keep your personnel and facilities protected. All of our products are 100 percent made in the USA, and are constructed of high-density polyethylene (HDPE) for excellent chemical resistance and maximum performance to meet EPA and SPCC compliance. This product line includes Budget Basins, Modular Platforms, Pallets, Sumps, IBC Containment Units, Outdoor Storage, Workstations and Spill Containment Boxes.

Eagle offers 3 Spill Containment options: Rigid, Flexible and Steel



*Modular Platform
easy to connect
with a built-in
U-channel*



*Poly Pallet
Ramp for easier
loading and
unloading*



All Eagle Basins, Pallets and Platforms feature high-performance engineered plastic construction for excellent chemical resistance and impact durability for long life. Pallets and Platforms are also UV Protected.

Removable grating for easy cleaning

Forklift pockets

Removable flat top grating

Modular platforms easy to connect with built-in U-channel

Most models available with and without drain



SPILL CONTAINMENT

BUDGET BASINS



Yellow No Drain	1636	1631	–
Yellow Drain	–	–	1638
Black No Drain	–	–	–
Black Drain	–	–	–
Common Name	1 Drum Budget Basin	2 Drum Budget Basin	4 Drum Budget Basin
Dimensions <small>Width Depth Height</small>	26¼ in./66.7 cm. 26¼ in./66.7 cm. 6½ in./16.6 cm.	26¼ in./66.7 cm. 51½ in./130.9 cm. 6½ in./16.6 cm.	51½ in./130.9 cm. 51½ in./130.9 cm. 8 in./20.4 cm.
Sump Capacity Drain Plug	17.5 gal./66.3 L Optional	34 gal./128.7 L Optional	66 gal./249.9 L Optional
Weight	12 lbs./5.5 kg.	20 lbs./9.1 kg.	25 lbs./11.4 kg.
Load Capacity <small>Uniform Distributed Load (UDL)</small>	5,000 lbs./2,268 kg.	5,000 lbs./2,268 kg.	5,000 lbs./2,268 kg.
Fork Pockets	No	No	No
Compliance	–	–	–
Use w/1689 Ramp	No	No	No

ADD LOW COST SPILL PROTECTION TO YOUR WORKPLACE



Model 16-DRAIN
Containment Drain

NEW

Designed for Eagle spill containment platforms and pallets that have built-in drain plugs. The 16-DRAIN connects into the 3/4 in. (1.905 cm.) port in the side of the tub to allow liquid in the tub to drain through the assembly. The assembly includes a replaceable absorbent sock (Model 16-FILTER) to collect oil allowing only water to discharge at the other end of the drain assembly for proper disposal. The assembly also has a plastic mesh screen inside to collect debris. When the absorbent sock in the assembly is fully saturated the liquid flow stops. The threaded drain assembly allows for easy removal and replacement of the absorbent sock. (Replacement sock kit sold separately Model 16-FILTER).



SPILL CONTAINMENT PALLETS



Yellow No Drain	1620ND	1645ND	1640ND	–
Yellow Drain	1620	1645	1640	1646
Black No Drain	1620BND	1645BND	1640BND	–
Black Drain	1620B	1645B	1640B	–
Common Name	2 Drum Pallet	4 Drum Pallet	4 Drum Pallet	4 Drum Nestable Pallet
Dimensions Width Depth Height	51 in./129.6 cm. 26¼ in./66.7 cm. 13¾ in./35 cm.	51½ in./130.9 cm. 51½ in./130.9 cm. 8 in./20.4 cm.	52½ in./130.9 cm. 51 in./129.6 cm. 13¾ in./35 cm.	58½ in./148.6 cm. 58½ in./148.6 cm. 7¾ in./19.7 cm.
Sump Capacity	66 gal./249.9 L	66 gal./249.9 L	132 gal./499.7 L	66 gal./249.9 L
Weight	52 lbs./23.6 kg.	67 lbs./30.4 kg.	104 lbs./47.2 kg.	72 lbs./32.7 kg.
Load Capacity Uniform Distributed Load (UDL)	4,000 lbs./1,814 kg.	8,000 lbs./3,628.8 kg.	8,000 lbs./3,628.8 kg.	6,000 lbs./2,721.6 kg.
Fork Pockets	Yes	Yes	Yes	Yes
Compliance				
Use w/1689 Ramp	No	Yes	No	Yes

Eagle Tarps are designed to fit Eagle's Spill Containment Products. Tarps help prevent contamination of drums and sump area, permit easy visual inspection, and keep rainwater and debris out when stored outdoors.

- Elasticized bottom with adjustable straps
- Attached document pouch for holding chemical information, MSDS sheets and other documents

Model No.	Description	Color	Weight	Dimensions
T8603	Tarp Cover for 2 Drum	Yellow	5 lbs. 2.3 kg.	in: 60L x 39.25W x 43.31H cm: 152.4L x 99.7W x 106.7H
T8604	Tarp Cover for 4 Drum	Yellow	7 lbs. 3.2 kg.	in: 56.5L x 56.5W x 44H cm: 143.6L x 143.6W x 111.8H
T8605	Tarp Cover for Single IBC Containment Unit	Yellow	11 lbs. 5 kg.	in: 80L x 76W x 73.75H cm: 203.2L x 193.1W x 187.4H
T8609	Tarp Cover for Drum Dollie	Yellow	4 lbs. 1.9 kg.	in: 71L x 34W x 26H cm: 180.4L x 86.4W x 66.1H

Eagle Tarps



SPILL CONTAINMENT

MODULAR SPILL PLATFORMS

			
1633	1632	16323	1635
1633D	1632D	–	1635D
1633B	1632B	–	1635B
1633BD	1632BD	–	1635BD
1 Drum Modular Platform	2 Drum Modular Platform	3 Drum Modular Platform	4 Drum Modular Platform
26¼ in./66.7 cm. 26 in./66.1 cm. 6½ in./16.6 cm.	26¼ in./66.7 cm. 51½ in./130.9 cm. 6½ in./16.6 cm.	26¼ in./66.7 cm. 77½ in./196.9 cm. 6½ in./16.6 cm.	51½ in./130.9 cm. 51½ in./130.9 cm. 6½ in./16.6 cm.
15 gal./56.8 L	30 gal./113.6 L	45 gal./170.3 L	60.5 gal./229.1 L
16 lbs./7.3 kg.	32 lbs./14.6 kg.	48 lbs./21.6 kg.	65 lbs./29.5 kg.
2,000 lbs./907.2 kg.	5,000 lbs./2,268 kg.	5,000 lbs./2,268 kg.	10,000 lbs./4,536 kg.
No	Yes	Yes	Yes
			 
No	Yes	Yes	Yes

FOR VOLUMES LESS THAN THE CAPACITY LISTED ABOVE

TYPICAL CONFIGURATIONS

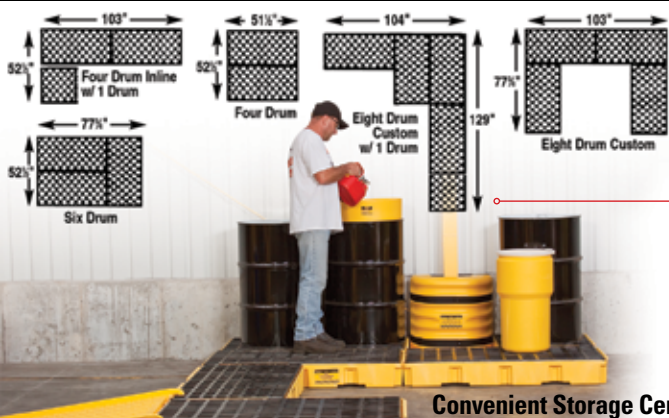

100% Recyclable

Modular design allows for multiple configurations. Easy to connect with built-in U-channel. Low profile for easy loading and unloading.

All Eagle Pallets & Platforms feature:
High-performance engineered plastic construction for excellent chemical resistance and impact durability for long life.



EPA 40 CFR 264.175: Container storage areas must have a containment system that has sufficient capacity to contain 10 percent of the volume of containers or the volume of the largest container, whichever is greater.



This marker indicates compliance with EPA spill prevention, control and countermeasures regulations.

Convenient Storage Center



MODULAR SPILL PLATFORMS



1647	1686	1688
1647D	1686D	1688D
1647B	1686B	1688B
1647BD	1686BD	1688BD
4 Drum In-Line Platform	6 Drum Platform	8 Drum Platform
103½ in./262.9 cm. 26¼ in./66.7 cm. 6½ in./16.6 cm.	78¼ in./198.8 cm. 51½ in./130.9 cm. 6½ in./16.6 cm.	103 in./261.7 cm. 51½ in./130.9 cm. 6½ in./16.6 cm.
60.5 gal./229.1 L	88 gal./333.2 L	121 gal./458.1 L (60.5 per side)
64 lbs./29.1 kg.	85 lbs./38.6 kg.	112 lbs./50.8 kg.
10,000 lbs./4,536 kg.	10,000 lbs./4,536 kg.	10,000 lbs./4,536 kg.
No	No	No
Yes	Yes	Yes

Did you know?

According to SPCC regulations, containment systems are required by any industry that deals with the storing and transportation of hazardous materials.



Model
1689BLK



100% Recyclable

Poly Pallet Ramps

Poly Ramp
in: 45½L x 32W x 8H
cm: 115.6L x 81.3W x 20.3H
Weight: 32 lbs. (14.6 kg.)
Capacity: 1,500 lbs. (680.4 kg.) (UDL)

For use with 1632, 1634,
1635, 1645, 1646, 1647,
1686, 1688, 1646RTC
and 1649

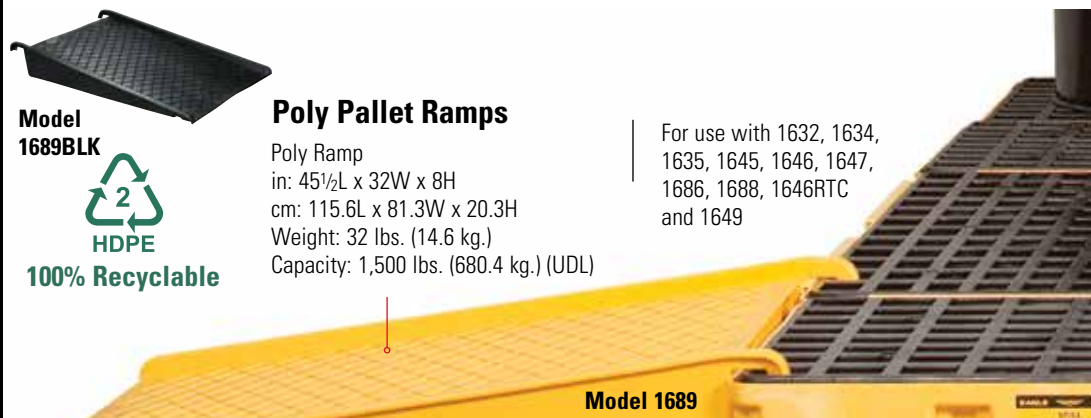

Model 1689

SPILL CONTAINMENT

METAL SPILL PALLETS



No Drain	1611ST	1620ST	1640ST
Drain	-	-	-
Common Name	1 Drum Steel Pallet	2 Drum Steel Pallet	4 Drum Steel Pallet
Dimensions Width Depth Height	25¼ in./65.4 cm. 27 in./68.6 cm. 6 in./15.3 cm.	51¼ in./130.2 cm. 27 in./68.6 cm. 13 in./58.5 cm.	54¼ in./137.8 cm. 54 in./137.2 cm. 12 in./30.5 cm.
Sump Capacity	17 gal./64.4 L	74 gal./280.2 L	92 gal./348.3 L
Weight	60 lbs./27.3 kg.	130 lbs./59 kg.	200 lbs./90.8 kg.
Load Capacity Uniform Distributed Load (UDL)	1,000 lbs./453.6 kg.	2,000 lbs./907.2 kg. (1,000 lbs./453.6 kg. per grate panel)	4,000 lbs./1,814.4 kg. (1,000 lbs./453.6 kg. per grate panel)
Fork Pockets	Yes	Yes	Yes
Compliance			

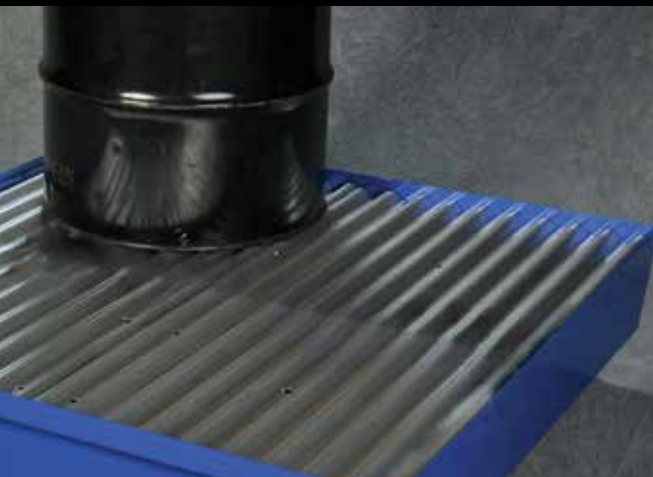

Metal Spill Pallet Features:

- Constructed of 12 Gauge Cold Rolled Steel
- Fully welded and leak tested
- Blue baked-on powder coat finish
- Fork-lift pockets in the front and back
- Heavy duty and durable
- For drum storage
- Grating has 1/2 in. (1.3 cm.) drain holes
- Grating removes for easy cleaning
- Load Capacity: 1,000 lbs. (453.6 kg.) (UDL) per grate

Model 1611STG

Grating Panel
25 in. x 26.5 in.
63.5 cm. x 26.5 cm.





HORIZONTAL DRUM STACKING SYSTEMS

			
1605	1606	1607	1608
–	–	–	–
Cradle	Single Stacker	Double Stacker	Shelf
29 in./73.7 cm. 26¼ in./66.7 cm. 22½ in./57.2 cm.	27 in./68.6 cm. 26¼ in./66.7 cm. 29 in./73.7 cm.	48 in./122 cm. 26½ in./67.4 cm. 13 in./33.1 cm.	19 in./48.3 cm. 23 in./106.7 cm. 19 in./48.3 cm.
–	–	–	–
30 lbs./13.6 kg.	30 lbs./13.6 kg.	30 lbs./13.6 kg.	15 lbs./6.8 kg.
2,000 lbs./907.2 kg.	1,000 lbs./453.6 kg.	2,000 lbs./907.2 kg.	100 lbs./45.4 kg.
–	–	Yes	–
			

Horizontal Stacking Systems

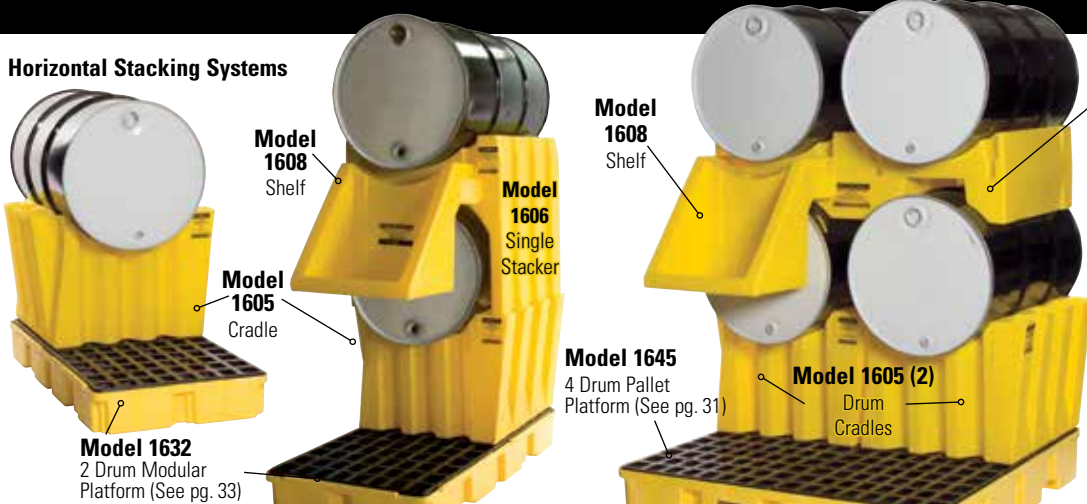

Model 1607
Double Stacker

Horizontal Drum Stacking System Drum Containment

Used in combination with our spill containment platforms, this product meets EPA Secondary Containment Storage requirements (40 CFR 264.175).

All components are 100 percent polyethylene, designed to lock into spill pallet grating for stable drum storage and are ideal for chemical storage and dispensing. Shelf attaches easily, allows for filling multiple containers at once and can be moved via forklift.

SPILL CONTAINMENT

OUTDOOR DRUM STORAGE

WORKSTATIONS

				
Yellow No Drain	–	1649	1626	1628
Yellow Drain	1645STC	–	–	–
Common Name	Soft Top Containment Unit	4 Drum Poly Storage Building	2 Drum Low-Profile Workstation	2 Drum High-Profile Workstation
Dimensions	Width Depth Height	Width Depth Height	Width Depth Height	Width Depth Height
	62 in./157.6 cm. 74 in./187.9 cm. 68 in./172.8 cm.	57½ in./146.1 cm. 57½ in./146.1 cm. 72 in./182.9 cm.	60 in./152.4 cm. 34 in./86.4 cm. 46 in./116.9 cm.	60 in./152.4 cm. 34 in./86.4 cm. 64 in./162.6 cm.
Sump Capacity	66 gal./249.9 L	66 gal./249.9 L	110 gal./416.4 L	220 gal./832.8 L
Weight	120 lbs./54.4 kg.	250 lbs./113.4 kg.	89 lbs./40.4 kg.	120 lbs./54.5 kg.
Load Capacity <small>Uniform Distributed Load (UDL)</small>	8,000 lbs./3628.8 kg.	8,000 lbs./3,628.8 kg.	4,000 lbs./1,814.4 kg.	4,000 lbs./1,814.4 kg.
Fork Pockets	Yes	Yes	Yes	Yes
Compliance				

Soft Top Containment

The NEW Eagle Soft Top Containment Unit (Model 1645STC) provides protection from the elements for up to four 55-gallon (208.2 L) drums with a durable soft top cover built on a 4-drum HDPE containment pallet. Ships unassembled for reduced shipping costs. Easy step-by-step assembly for a secure and quick weather resistant containment solution. The height of the cover allows storage with drum pumps in place.

The four drum pallet is 100% HDPE construction that resists corrosion and weathering. The flexible soft top is constructed of high-vis yellow PVC fabric over a rugged galvanized steel frame. Access drums through the front or back. For maximum loading and unloading ease use with the Eagle HDPE Poly Ramp (Model 1689 – Sold Separately.)



4 Drum Poly Storage Building

Securely stores up to four 55-gallon (208.2 L) drums. Features four-way forklift pockets, vented door louvers, removable grating and top hooks for moving. **[Note:]** Top hooks are intended only for moving empty building. Door opening accepts up to a 48 in. x 48 in. (122 cm. x 122 cm.) pallet. (Use a cable to lock.)



2 Drum Workstations

A secure way to store drums inside or outside. Available in low (1626) or high (1628) profile for the storage of two drums. Units can be moved via forklift and have optional dolly allowing for easier movement on worksite. Includes locks for secure storage.

Model 1629

Workstation Dolly 1,500 lbs. (680.4 L) capacity (UDL)





IBC CONTAINMENT UNITS



Model 1682 Metal Platform
60 in. x 60 in. x 22 in.
152.4 cm. x 152.4 cm. x 55.9 cm.



1681 (Tub Only)



1683STC



1681 (Tub Only)

1682-P Poly Platform
55 in. x 55 in. x 25 in.
139.7 cm. x 139.7 cm. x 63.5 cm.



1681-2 (Tub Only)

	1680	1683STC	1683	1684
Yellow No Drain				
Yellow Drain	—	—	1683D	1684D
Black No Drain	—	—	1683B	1684B
Black Drain	—	—	1683BD	1684BD
Common Name	IBC Containment Unit with Steel Platform	IBC Containment Unit with Soft Top Cover and Poly Platform (Tank not included)	IBC Containment Unit with Poly Platform (Tank not included)	Double All Poly IBC Containment Unit (Tank not included)
Dimensions Width Depth Height	67 in./170.2 cm. 67 in./170.2 cm. 26 in./66.1 cm.	84.4 in./214.4 cm. 67.3 in./170.9 cm. 91.9 in./233.4 cm.	67 in./170.2 cm. 67 in./170.2 cm. 26 in./66.1 cm.	118 in./299.8 cm. 77½ in./196.9 cm. 20 in./50.8 cm.
Sump Capacity	400 gal./1,514.2 L	400 gal./1,514.2 L	400 gal./1,514.2 L	400 gal./1,514.2 L
Weight	270 lbs./122.5 kg.	315 lbs./142.9 kg.	245 lbs./111.1 kg.	538 lbs./244 kg.
Load Capacity <small>Uniform Distributed Load (UDL)</small>	10,000 lbs./4,536 kg.	10,000 lbs./4,536 kg.	10,000 lbs./ 4,536 kg.	20,000 lbs./9,071.8 kg. (10,000 lbs./4,536 kg. per platform)
Fork Pockets	No	No	No	No
Compliance				

Did you know?

Use a 1645STC Kit to convert an Eagle 1645 model into a 1645STC. Use a 1683STC Kit to convert an Eagle 1683 model into a 1683STC. (Kits ship flat. Assembly required.)



IBC Spill Units:

- Come with 100 percent polyethylene containment tub and your choice of metal or poly platforms
- **Model 1684** includes two front bucket wells for easy dispensing



HDPE

100% Recyclable



SPILL CONTAINMENT

SPILL CONTAINMENT SUMPS AND SPILL KIT BOXES

			 	 
No Drain	16-275	16-550	1624K 1624KB	1625K 1625KB
Drain	16-275D	16-550D	–	–
Common Name	Horizontal Tank Spill Containment Sump	Horizontal Tank Spill Containment Sump	Spill Kit Box with Lid	Spill Kit Box with Lid
Dimensions <small>Width Depth Height</small>	44 in./111.8 cm. 84 in./213.4 cm. 30 in./76.2 cm.	62 in./157.5 cm. 88 in./223.6 cm. 33 in./83.9 cm.	60 in./152.4 cm. 34 in./86.4 cm. 24 in./61 cm.	60 in./152.4 cm. 34 in./86.4 cm. 42 in./106.7 cm.
Sump Capacity	373 gal./1,412 L	635 gal./2,403.8 L	110 gal./416.4 L	220 gal./832.8 L
Weight	96 lbs./43.1 kg.	118 lbs./53.6 kg.	75 lbs./34.1 kg.	110 lbs./49.9 kg.
Load Capacity <small>Uniform Distributed Load (UDL)</small>	10,000 lbs./4,536 kg.	10,000 lbs./4,536 kg.	–	–
Fork Pockets	No	No	Yes	Yes
Compliance			–	–



Model 16-275

Spill Containment Sumps:

- Economical containment solutions for 275- (1,040 L) & 550-gallon (2,081 L) horizontal tanks
- One-piece molded HDPE design that will not rust or corrode



Model 1624K
with 1624
Caster Kit



Model 1624CASTER

Wheel kit with 6 casters for 1624K, 1624KB, 1625K, 1625KB (Assembly Required) (Kit Sold Separately)

Spill Kit Boxes:

Spill Kit Boxes come in two sizes (110- and 220-gallon/416.4 and 832.8 L) in yellow or black HDPE, and work well for both routine maintenance and emergency spill response. Optional wheel kit (1624CASTER) sold separately. (two locking and two swivel - 6 in. casters)



DRUM CONTAINMENT DOLLIE

DRUM BOGIE

E-CART



Model	1617Y	1613	1696Y	1697Y
Item	Drum Containment Dollie	Drum Bogie	65 e-CART Wheeled Spill Kit Cart	95 e-CART Wheeled Spill Kit Cart
Dimensions <small>Width Depth Height</small>	31¾ in./81 cm. 69 in./175.2 cm. 26½ in./67 cm.	35¾ in./90 cm. 42 in./106 cm. -	26 in./66.1 cm. 30 in./76.2 cm. 42½ in./108 cm.	36 in./91.5 cm. 30 in./76.2 cm. 44 in./111.8 cm.
Sump Capacity	70 gal./266 L	12 gal./45.6 L	65 gal./247 L	95 gal./359.7 L
Weight	98 lbs./44.5 kg.	30 lbs./13.5 kg.	32 lbs./14.6 kg.	38 lbs./17.3 kg.
Load Capacity <small>Uniform Distributed Load (UDL)</small>	600 lbs./270 kg.	1250 lbs./526 kg.	-	-

Drum Containment Dollie

The Eagle Drum Containment Dollie is constructed of Yellow HDPE with double black straps for easy loading, and its lightweight design with rounded handles for easy tipping. The Dollie transports 55-gallon (208.2 L) drums with ease, and tilts to become a self-dispensing unit. It also acts as its own secondary containment unit.

Features

- Tough yellow polyethylene construction with a lightweight design
- Extra large, easy roll 10 in. (25.4 cm.) poly wheels
- Drain Plug that simplifies removal of contents from sump
- Holds up to 600 lbs. (272.2 kg.) (UDL)
- Double buckle and strap
- Forkliftable from the rear
- Molded handles
- Rounded handle makes lifting easy



Model 1617Y
Drum Containment Dollie

Model T8609
Fitted and durable poly cover available to protect from the elements

Drum Bogie

Mobile dispensing unit protects against incidental spills and leaks for 30- (113.6 L), 55- (208.2 L) and 95-gallon (359.7 L) drums. The durable polyethylene Bogie resists corrosion; has five swivel casters for maximum stability, load capacity and maneuverability; and features a poly push-pull handle. Ships via UPS.



Eagle e-CART Wheeled Spill Kit Cart Features:

- Constructed of durable HDPE
- Ergonomically designed handles
- Double-walled hinged lid with a hold-down tab
- Rugged galvanized steel bar handles
- HDPE wheels on a heavy duty steel axle
- Wear tabs on the bottom
- Ergonomically designed



SPILL CONTAINMENT

Containment Utility Tray

This HDPE tray is an affordable way to contain small spills up to five gallons. For countertop use for the working storage of lab chemicals, as a drip pan under dispensers, or as a floor tray under machinery. These trays are stackable for easy storage and feature a ribbed bottom.



Model No.	Item	Dimensions	Weight
1677	Containment Utility Tray (Yellow)	18 in. x 36 in. x 2 in. 45.8 cm. x 91.5 cm. x 5 cm.	9 lbs./4.1 kg.
1677 BLACK	Containment Utility Tray (Black)	18 in. x 36 in. x 2 in. 45.8 cm. x 91.5 cm. x 5 cm.	9 lbs./4.1 kg.

Model 1677 (Yellow)
Containment Utility Tray
18 in. x 36 in. x 2 in.
45.8 cm. x 91.5 cm. x 5.1 cm.

Model 1677 BLACK
Containment Utility Tray
18 in. x 36 in. x 2 in.
45.8 cm. x 91.5 cm. x 5.1 cm.



Pallet Grating Available

For use with pallets and platforms on pages 31-33

Model 1642IB

Model No.	Dimensions	Grating Opening
1642IB Grating	51½ in. x 25¼ in./130.9 cm. x 64.2 cm.	2½ in. x 3¾ in. max./6.4 cm. x 8.1 cm.
1642B Grating	51½ in. x 25¼ in./130.9 cm. x 64.2 cm.	1½ in. x 1½ in. max./4.5 cm. x 4.5 cm.
1642IS Grating	25¼ in. x 25¼ in./64.2 cm. x 64.2 cm.	2½ in. x 3¾ in. max./6.4 cm. x 8.1 cm.

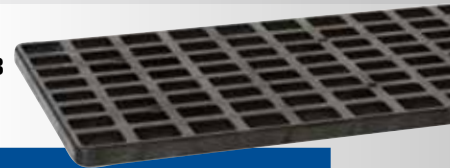

Single Drum Containment Unit

The Single Drum Containment Unit (1612) is ideal for not only use as a spill containment unit, but also a mobile pumping station or waste collection station. With the addition of model 1698 overpack dolly, the drum is easy to move for dispensing and collection.

Compliance: EPA 40 CFR 264.175



HDPE

100% Recyclable

Model 1954 Drum Lifter



Model 1958 Drum Lifter



Model 1698 Overpack Dolly



Model No.	Item	Dimensions	Weight	Load Capacity (UDL)
1612	Single Drum Unit	31 in. x 33 in. 78.8 cm. x 83.9 cm.	30 lbs./13.6 kg.	1,000 lbs./453.6 kg.
1954	Vertical Drum Lifter	—	12 lbs./5.5 kg.	1,000 lbs./453.6 kg.
1958	Horizontal Drum Lifter	—	5 lbs./2.3 kg.	1,000 lbs./453.6 kg.
1698	Overpack Dolly	21.5 in. x 7 in. 69.9 cm. x 17.8 cm.	30 lbs./13.6 kg.	1,000 lbs./453.6 kg.

Model 1612

Single Drum Unit can be used with model 1698 overpack dolly





Mobile Spill Platform and Drum Accessories

Mobile Spill Control Platform

The safety of a spill containment platform with the convenience of mobility; safely transfer containers between workstations.

Drum Funnel and Cover

The 18 in. (45.8 cm.) wide drum funnel fits both 30- (113.5 L) and 55-gallon (208.2 L) drums. The 6 in. (15.3 cm.) high side walls reduce splashing and spout fits any 2 in. (5.1 cm.) NPT bung. The optional funnel cover keeps out dirt and contaminants.

Compliance: EPA 40 CFR 265.173.

Drum Covers

HDPE construction, covers for closed (1666) or open (1667) head drums.

Drum Tray and Drip Pan

Eagle Poly Drum Tray is ideal under drums where dispensing or filling takes place. The drip pan catches up to one gallon of oils, coolants, water or other non-aggressive liquids. Constructed of high density polyethylene (HDPE). Model 1614 without black HDPE grating, Model 1615 with black HDPE grating. For use with Eagle Model 1618 - Drum Tray Dolly with four 3 inch casters.



2,000 lb./902.2 kg. load capacity

Model 1637 Mobile Spill Platform - 30-gallon (113.6 L) capacity. Lab Pack and Drum not included (2 locking and 2 swivel casters)



Model 1660 Drum Funnel
Model 1664 Drum Funnel Cover



Model 1670 Drip Pan Filled with Polypropylene



Model 1666

Drum Covers

Model 1667

Model No.	Item	Dimensions	Weight	Load Capacity (UDL)
1614	Drum Tray	in: 31 x 6 cm: 78.8 x 15.3	20 lbs./9.1 kg.	—
1615	Drum Tray with Grating	in: 31 x 6 cm: 78.8 x 15.3	24 lbs./10.9 kg.	—
1618	Drum Tray Dolly	in: 31 x 7 cm: 78.8 x 17.8	32 lbs./14.6 kg.	1,000 lbs./453.6 kg.
1637	Mobile Spill Control Platform	in: 28 x 56 x 41 cm: 71.2 x 142.3 x 104.2	92 lbs./41.8 kg.	2,000 lbs./907.2 kg.
1622	2 Drum Pallet Tarp	in: 52 x 27 x 41 cm: 132.1 x 68.6 x 104.2	4 lbs./1.9 kg.	—
1622	4 Drum Pallet Tarp	in: 54 x 54 x 40 cm: 137.2 x 137.2 x 101.6	6 lbs./2.8 kg.	—
1952	Overpack Hand Truck	—	84 lbs./38.1 kg.	1,000 lbs./453.6 kg.
1660	Drum Funnel	in: 18 x 7 cm: 45.8 x 17.8	11 lbs./5 kg.	—
1662	Drum Funnel with Screen	in: 18 x 7 cm: 45.8 x 17.8	11 lbs./5 kg.	—
1664	Drum Funnel Cover	in: 18½ x 5 cm: 47 x 12.7	1 lb./,5 kg.	—
1666	Drum Cover - Closed Head	in: 23 x 5 cm: 58.5 x 12.7	2.5 lbs./1.4 kg.	—
1667	Drum Cover - Open Head	in: 24 x 5 cm: 61 x 12.7	2.5 lbs./1.4 kg.	—
1670	Drip Pan	in: 10½ x 10½ x 3 cm: 26.7 x 26.7 x 7.7	1 lb./,5 kg.	—



Model 1614 Drum Tray
Model 1618 Drum Tray Dolly with Four 3 in. (7.7 cm.) casters



Model 1952 Overpack Hand Truck

FLEXIBLE CONTAINMENT



Model T8001

Eagle Quik-Deploy™ Spill NEST™

The Eagle Quik-Deploy™ Spill NEST™ is a compact and affordable solution for fast response to leaks and drips. This product features a 4 in. low profile sidewall and is available in six sizes, which are leak tested before shipment. Made in the USA.

Perfect for:

- Changing oils and fluids
- Quick use under leaking vehicles
- Protecting bottom surfaces while dispensing
- Performing maintenance on an item with spill potential
- Constructed of PVC Coated Fabric
- Made in the USA



Model No.	Description	Weight	Spill Capacity	Compliance
T8001	Quik-Deploy™ Spill NEST™ 2 ft. x 2 ft. x 4 in./ .6 m. x .6 m. x 10.2 cm.	1 lb./ .5 kg.	10 gal./37.9 L	
T8002	Quik-Deploy™ Spill NEST™ 2 ft. x 3 ft. x 4 in./ .6 m. x .9 m. x 10.2 cm.	3 lbs./1.4 kg.	15 gal./56.8 L	
T8003	Quik-Deploy™ Spill NEST™ 2 ft. x 4 ft. x 4 in./ .61 m. x 1.3 m. x 10.2 cm.	4 lbs./1.9 kg.	20 gal./75.7 L	
T8004	Quik-Deploy™ Spill NEST™ 3 ft. x 3 ft. x 4 in./ .9 m. x .9 m. x 10.2 cm.	5 lbs./2.3 kg.	22.5 gal./85.2 L	
T8005	Quik-Deploy™ Spill NEST™ 4 ft. x 4 ft. x 4 in./1.22 m. x 1.22 m. x 10.2 cm.	5.5 lbs./2.5 kg.	40 gal./151 L	
T8006	Quik-Deploy™ Spill NEST™ 4 ft. x 6 ft. x 4 in./1.22 m. x 1.9 m. x 10.2 cm.	7 lbs./3.2 kg.	60 gal./227 L	

Eagle Quik-Deploy™ Folding Spill NEST™

The Eagle Quik-Deploy™ Folding Spill NEST™ has the same durable, high-quality construction as the Quik-Deploy™ Spill NEST™.

Features:

- A thinner 2 in. (5.1 cm.) sidewall width
- A safety-secure strap for easy folding and storage
- An extended 6 in. (15.3 cm.) sidewall height that allows for up to 30 percent more spill capacity
- Conveniently folds saving shipping and storage space
- Constructed of PVC Coated Fabric
- Made in the USA

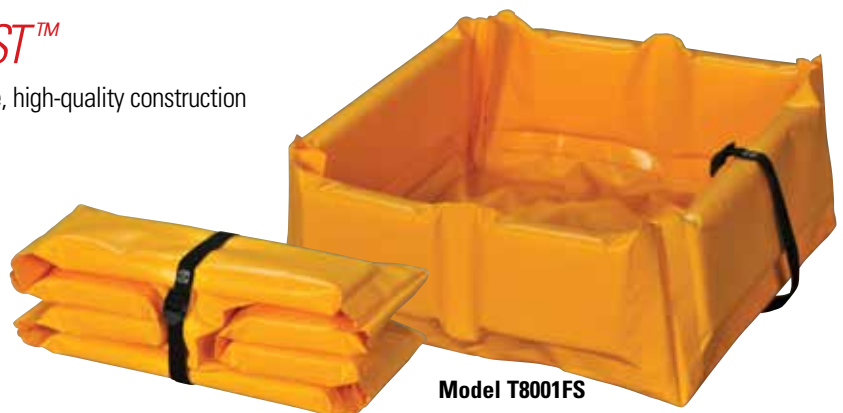

Model T8001FS

Model No.	Description	Weight	Spill Capacity	Compliance
T8001FS	Quik-Deploy™ Folding Spill NEST™ 2 ft. x 2 ft. x 6 in./ .61 m. x .61 m. x 15 cm.	1 lb./ .5 kg.	15 gal./56.8 L	
T8002FS	Quik-Deploy™ Folding Spill NEST™ 2 ft. x 3 ft. x 6 in./ .61 m. x .91 m. x 15 cm.	3 lbs./1.4 kg.	22 gal./83.3 L	
T8003FS	Quik-Deploy™ Folding Spill NEST™ 2 ft. x 4 ft. x 6 in./ .61 m. x 1.22 m. x 15 cm.	4 lbs./1.9 kg.	30 gal./113.6 L	
T8004FS	Quik-Deploy™ Folding Spill NEST™ 3 ft. x 3 ft. x 6 in./ .91 m. x .91 m. x 15 cm.	5 lbs./2.3 kg.	34 gal./128.7 L	
T8005FS	Quik-Deploy™ Folding Spill NEST™ 4 ft. x 4 ft. x 6 in./1.22 m. x 1.22 m. x 15 cm.	5.5 lbs./2.5 kg.	60 gal./227.2 L	
T8006FS	Quik-Deploy™ Folding Spill NEST™ 4 ft. x 6 ft. x 6 in./1.22 m. x 1.83 m. x 15 cm.	7 lbs./3.2 kg.	74 gal./280.2 L	





Eagle SpillNEST™

Available with or without grating

The Eagle SpillNEST™ line delivers easy-to-use, affordable, temporary spill containment for drums, machine parts, small equipment and other jobsite needs. This new product is available with or without the classic black HDPE grating used in Eagle's market-leading HDPE Spill Containment Pallets. Available in six sizes.

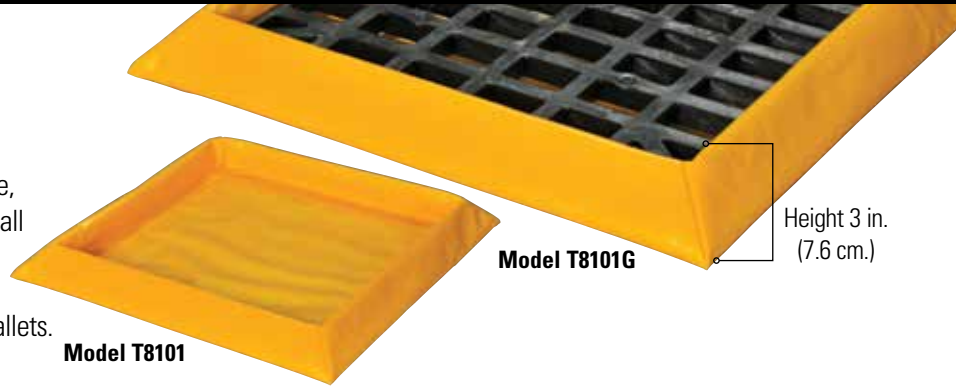

Features:

- Foam sidewalls that easily spring back into place after pressure is applied
- Folds for easy storage
- Affordable and reusable
- No need for ramps, drive in and drive out with hand trucks
- Constructed of PVC Coated Fabric
- Made in the USA

Model T8101G



Model No.	Description	Weight	Spill Capacity*	Compliance
T8101	1 Drum SpillNEST™ 32.25 in. x 32.25 in./ .82 m. x .82 m.	2 lbs./ .9 kg.	10 gal./37.9 L	 
T8101G	1 Drum SpillNEST™ with Grate 32.25 in. x 32.25 in./ .82 m. x .82 m.	7 lbs./3.2 kg.	10 gal./37.9 L	
T8102	2 Drum SpillNEST™ 32.25 in. x 57.75 in./ .82 m. x 1.47 m.	4 lbs./1.9 kg.	15 gal./56.8 L	
T8102G	2 Drum SpillNEST™ with Grate 32.25 in. x 57.75 in./ .82 m. x 1.47 m.	15 lbs./6.8 kg.	15 gal./56.8 L	
T8103	4 Drum SpillNEST™ 57.75 in. x 57.75 in./1.47 m. x 1.47 m.	8 lbs./3.7 kg.	30 gal./113.6 L	
T8103G	4 Drum SpillNEST™ with Grate 57.75 in. x 57.75 in./1.47 m. x 1.47 m.	30 lbs./13.6 kg.	30 gal./113.6 L	
T8104	4 Drum In-Line SpillNEST™ 32.25 in. x 107.75 in./ .82 m. x 2.74 m.	8 lbs./3.7 kg.	30 gal./113.6 L	
T8104G	4 Drum In-Line SpillNEST™ with Grate 32.25 in. x 107.75 in./ .82 m. x 2.74 m.	30 lbs./13.6 kg.	30 gal./113.6 L	
T8105	6 Drum SpillNEST™ 57.75 in. x 83 in./1.47 m. x 2.10 m.	12 lbs./ 5.6 kg.	45 gal./170.4 L	
T8105G	6 Drum SpillNEST™ with Grate 57.75 in. x 83 in./1.47 m. x 2.10 m.	45 lbs./20.6 kg.	45 gal./170.4 L	
T8106	8 Drum SpillNEST™ 57.5 in. x 108.5 in./1.47 m. x 2.76 m.	13 lbs./5.9 kg.	60 gal./227.2 L	
T8106G	8 Drum SpillNEST™ with Grate 57.5 in. x 108.5 in./1.47 m. x 2.76 m.	57 lbs./25.9 kg.	60 gal./227.2 L	

*Some capacities may not meet EPA containment requirements.



Eagle SpillNEST™ Berm with Removable Sidewalls

The Eagle SpillNEST™ Berm with Removable Sidewalls assists with safety and compliance on the job site. Available in Economy, Standard and Heavy Duty designs. The sturdy design incorporates high strength connectors and a two-way air relief system to facilitate automatic entry and exit at any angle.

Conveniently folds, stacks and stores on a shelf or in a container for immediate use, setup and reuse. To maintain quality and life of your SpillNEST™ Berm, Eagle offers accessories including Ground Pads, Track Mats and Storage Bags.

- For oil and gas sites and other large area applications
- Easy to assemble
- Folds, stacks and stores conveniently
- Ready for immediate setup and use
- Durable and reusable
- 13 sizes available
- Made in the USA
- Available in Economy, Standard and Heavy Duty material variations
- Entry and exit from any point without harming foam logs



Heavy Duty

Standard

Economy

3 material variations:

- Economy SpillNEST™ Berm is designed for indoor and temporary outdoor use (Yellow PVC)
- Standard SpillNEST™ Berm is designed for indoor and outdoor use with moderate to heavy traffic (Black XR5 Material)
- Heavy Duty SpillNEST™ Berm is designed for rugged outdoor use with heavy to extreme traffic (Tan PTFE)



Eagle SpillNEST™ Berm with Removable Side Walls

Model	Description	Ship Weight	Ground Pad	Track Mat	Compliance
T8201BK T8201TN T8201YE	505 gal./1,912 L, Standard - 12 ft. x 15 ft. x 4.5 in./3.65 m. x 4.50 m. x 11.43 cm. - Black 438 gal./1,658 L, Heavy Duty - 12 ft. x 13 ft. x 4.5 in./3.65 m. x 3.96 m. x 11.43 cm. - Tan 505 gal./1,912 L, Economy - 12 ft. x 15 ft. x 4.5 in./3.65 m. x 4.50 m. x 11.43 cm. - Yellow	58 lbs./26.3 kg. 61 lbs./27.7 kg. 47 lbs./21.3 kg.	T8201GP T8201GP T8201GP	T8201TM T8201TM T8201TM	
T8202BK T8202TN T8202YE	707 gal./2,676 L, Standard - 12 ft. x 21 ft. x 4.5 in./3.65 m. x 6.40 m. x 11.43 cm. - Black 640 gal./2,423 L, Heavy Duty - 12 ft. x 19 ft. x 4.5 in./3.65 m. x 5.79 m. x 11.43 cm. - Tan 707 gal./2,676 L, Economy - 12 ft. x 21 ft. x 4.5 in./3.65 m. x 6.40 m. x 11.43 cm. - Yellow	70 lbs./31.8 kg. 75 lbs./34.1 kg. 56 lbs./25.4 kg.	T8202GP T8202GP T8202GP	T8202TM T8202TM T8202TM	
T8203BK T8203TN T8203YE	1,110 gal./4,202 L, Standard - 12 ft. x 33 ft. x 4.5 in./3.65 m. x 10.06 m. x 11.43 cm. - Black 1,010 gal./3,823 L, Heavy Duty - 12 ft. x 30 ft. x 4.5 in./3.65 m. x 9.14 m. x 11.43 cm. - Tan 1,110 gal./4,202 L, Economy - 12 ft. x 33 ft. x 4.5 in./3.65 m. x 10.06 m. x 11.43 cm. - Yellow	105 lbs./47.6 kg. 112 lbs./50.8 kg. 84 lbs./38.1 kg.	T8203GP T8203GP T8203GP	T8203TM T8203TM T8203TM	
T8204BK T8204TN T8204YE	1,310 gal./4,959 L, Standard - 12 ft. x 39 ft. x 4.5 in./3.65 m. x 11.89 m. x 11.43 cm. - Black 1,380 gal./5,224 L, Heavy Duty - 12 ft. x 41 ft. x 4.5 in./3.65 m. x 12.50 m. x 11.43 cm. - Tan 1,310 gal./4,959 L, Economy - 12 ft. x 39 ft. x 4.5 in./3.65 m. x 11.89 m. x 11.43 cm. - Yellow	140 lbs./63.5 kg. 150 lbs./68.0 kg. 112 lbs./50.8 kg.	T8204GP T8204GP T8204GP	T8204TM T8204TM T8204TM	
T8205BK T8205TN T8205YE	1,715 gal./6,492 L, Standard - 12 ft. x 51 ft. x 4.5 in./3.65 m. x 15.54 m. x 11.43 cm. - Black 1,750 gal./6,625 L, Heavy Duty - 12 ft. x 52 ft. x 4.5 in./3.65 m. x 12.50 m. x 11.43 cm. - Tan 1,715 gal./6,492 L, Economy - 12 ft. x 51 ft. x 4.5 in./3.65 m. x 15.54 m. x 11.43 cm. - Yellow	175 lbs./79.4 kg. 185 lbs./83.9 kg. 140 lbs./63.5 kg.	T8205GP T8205GP T8205GP	T8205TM T8205TM T8205TM	
T8206BK T8206TN T8206YE	2,121 gal./8,029 L, Standard - 12 ft. x 63 ft. x 4.5 in./3.65 m. x 19.2 m. x 11.43 cm. - Black 2,121 gal./8,029 L, Heavy Duty - 12 ft. x 63 ft. x 4.5 in./3.65 m. x 19.2 m. x 11.43 cm. - Tan 2,121 gal./8,029 L, Economy - 12 ft. x 63 ft. x 4.5 in./3.65 m. x 19.2 m. x 11.43 cm. - Yellow	210 lbs./95.3 kg. 223 lbs./101.2 kg. 168 lbs./76.2 kg.	T8206GP T8206GP T8206GP	T8206TM T8206TM T8206TM	
T8207BK T8207TN T8207YE	2,626 gal./9,941 L, Standard - 24 ft. x 39 ft. x 4.5 in./7.32 m. x 11.89 m. x 11.43 cm. - Black 2,760 gal./10,448 L, Heavy Duty - 24 ft. x 41 ft. x 4.5 in./7.32 m. x 12.50 m. x 11.43 cm. - Tan 2,626 gal./9,941 L, Economy - 24 ft. x 39 ft. x 4.5 in./7.32 m. x 11.89 m. x 11.43 cm. - Yellow	280 lbs./127 kg. 310 lbs./141 kg. 224 lbs./102 kg.	T8207GP T8207GP T8207GP	T8207TM T8207TM T8207TM	
T8208BK T8208TN T8208YE	3,434 gal./12,999 L, Standard - 24 ft. x 51 ft. x 4.5 in./11.89 m. x 15.54 m. x 11.43 cm. - Black 3,501 gal./13,253 L, Heavy Duty - 24 ft. x 52 ft. x 4.5 in./11.98 m. x 15.85 m. x 11.43 cm. - Tan 3,434 gal./12,999 L, Economy - 24 ft. x 51 ft. x 4.5 in./11.89 m. x 15.54 m. x 11.43 cm. - Yellow	340 lbs./154 kg. 360 lbs./163 kg. 272 lbs./123 kg.	T8208GP T8208GP T8208GP	T8208TM T8208TM T8208TM	
T8209BK T8209TN T8209YE	4,241 gal./16,054 L, Standard - 24 ft. x 63 ft. x 4.5 in./11.98 m. x 19.20 m. x 11.43 cm. - Black 4,241 gal./16,054 L, Heavy Duty - 24 ft. x 63 ft. x 4.5 in./11.98 m. x 19.20 m. x 11.43 cm. - Tan 4,241 gal./16,054 L, Economy - 24 ft. x 63 ft. x 4.5 in./11.98 m. x 19.20 m. x 11.43 cm. - Yellow	410 lbs./186 kg. 435 lbs./197 kg. 328 lbs./149 kg.	T8209GP T8209GP T8209GP	T8209TM T8209TM T8209TM	
T8210BK T8210TN T8210YE	3,939 gal./14,911 L, Standard - 36 ft. x 39 ft. x 4.5 in./10.97 m. x 11.89 m. x 11.43 cm. - Black 4,140 gal./15,672 L, Heavy Duty - 36 ft. x 41 ft. x 4.5 in./10.97 m. x 12.50 m. x 11.43 cm. - Tan 3,939 gal./14,911 L, Economy - 36 ft. x 39 ft. x 4.5 in./10.97 m. x 11.89 m. x 11.43 cm. - Yellow	385 lbs./175 kg. 403 lbs./183 kg. 308 lbs./140 kg.	T8210GP T8210GP T8210GP	T8210TM T8210TM T8210TM	
T8211BK T8211TN T8211YE	5,150 gal./19,495 L, Standard - 36 ft. x 51 ft. x 4.5 in./10.97 m. x 15.54 m. x 11.43 cm. - Black 5,251 gal./19,877 L, Heavy Duty - 36 ft. x 52 ft. x 4.5 in./10.97 m. x 15.85 m. x 11.43 cm. - Tan 5,150 gal./19,495 L, Economy - 36 ft. x 51 ft. x 4.5 in./10.97 m. x 15.54 m. x 11.43 cm. - Yellow	515 lbs./234 kg. 535 lbs./243 kg. 412 lbs./187 kg.	T8211GP T8211GP T8211GP	T8211TM T8211TM T8211TM	
T8212BK T8212TN T8212YE	6,362 gal./24,083 L, Standard - 36 ft. x 63 ft. x 4.5 in./10.97 m. x 19.20 m. x 11.43 cm. - Black 6,362 gal./24,083 L, Heavy Duty - 36 ft. x 63 ft. x 4.5 in./10.97 m. x 19.20 m. x 11.43 cm. - Tan 6,362 gal./24,083 L, Economy - 36 ft. x 63 ft. x 4.5 in./10.97 m. x 19.20 m. x 11.43 cm. - Yellow	650 lbs./295 kg. 690 lbs./313 kg. 520 lbs./236 kg.	T8212GP T8212GP T8212GP	T8212TM T8212TM T8212TM	
T8213BK T8213TN T8213YE	8,483 gal./32,112 L, Standard - 48 ft. x 63 ft. x 4.5 in./14.60 m. x 19.20 m. x 11.43 cm. - Black 8,483 gal./32,112 L, Heavy Duty - 48 ft. x 63 ft. x 4.5 in./14.60 m. x 19.20 m. x 11.43 cm. - Tan 8,483 gal./32,112 L, Economy - 48 ft. x 63 ft. x 4.5 in./14.60 m. x 19.20 m. x 11.43 cm. - Yellow	800 lbs./363 kg. 850 lbs./286 kg. 640 lbs./290 kg.	T8213GP T8213GP T8213GP	T8213TM T8213TM T8213TM	
T8200-64 T8200-70	Removable Foam Log - 64 in. x 4.5 in. x 4.5 in./162.56 cm. x 11.43 cm. x 11.43 cm. - Yellow Removable Foam Log - 70 in. x 4.5 in. x 4.5 in./177.80 cm. x 11.43 cm. x 11.43 cm.	8 lbs./3.6 kg. 9 lbs./4.1 kg.	— —	— —	



Model T8421

Model No.	Description	Weight	Spill Cap.	Compliance
T8421	Talon™ SX Berm - Black 4 ft. x 4 ft. x 8 in./1.22 m. x 1.22 m. x 20 cm.	11 lbs./5 kg.	80 gal./303 L	
T8422	Talon™ SX Berm - Black 4 ft. x 4 ft. x 1 ft./1.22 m. x 1.22 m. x 30 cm.	18 lbs./8.2 kg.	119 gal./451 L	
T8423	Talon™ SX Berm - Black 4 ft. x 6 ft. x 8 in./1.22 m. x 1.83 m. x 20 cm.	25 lbs./11.3 kg.	119 gal./451 L	SPCC COMPLIANT
T8424	Talon™ SX Berm - Black 4 ft. x 6 ft. x 1 ft./1.22 m. x 1.83 m. x 30 cm.	28 lbs./12.7 kg.	179 gal./678 L	SPCC COMPLIANT
T8425	Talon™ SX Berm - Black 4 ft. x 8 ft. x 8 in./1.22 m. x 2.44 m. x 20 cm.	21 lbs./9.5 kg.	159 gal./602 L	
T8426	Talon™ SX Berm - Black 5 ft. x 10 ft. x 1 ft./1.52 m. x 3.05 m. x 20 cm.	45 lbs./20.4 kg.	374 gal./1,416 L	NPDES
T8427	Talon™ SX Berm - Black 6 ft. x 6 ft. x 1 ft./1.83 m. x 1.83 m. x 30 cm.	37 lbs./16.8 kg.	269 gal./1,018 L	NPDES
T8428	Talon™ SX Berm - Black 8 ft. x 8 ft. x 8 in./2.44 m. x 2.44 m. x 20 cm.	35 lbs./15.9 kg.	319 gal./1,208 L	
T8429	Talon™ SX Berm - Black 10 ft. x 10 ft. x 1 ft./3.05 m. x 3.05 m. x 20 cm.	60 lbs./27.2 kg.	748 gal./2,832 L	EPA
T8430	Talon™ SX Berm - Black 12 ft. x 12 ft. x 1 ft./3.65 m. x 3.65 m. x 30 cm.	80 lbs./36.3 kg.	1,077 gal./4,077 L	EPA
T8431	Talon™ SX Berm - Black 16 ft. x 16 ft. x 1 ft./4.87 m. x 4.87 m. x 30 cm.	113 lbs./51.3 kg.	1,914 gal./7,245 L	
T8432	Talon™ SX Berm - Black 10 ft. x 26 ft. x 1 ft./3.05 m. x 7.93 m. x 30 cm.	122 lbs./55.3 kg.	1,944 gal./7,359 L	
T8433	Talon™ SX Berm - Black 10 ft. x 40 ft. x 1 ft./3.05 m. x 12.19 m. x 30 cm.	150 lbs./68.0 kg.	2,992 gal./11,326 L	EPA 40 CFR 264.175, SPCC, NPDES
T8434	Talon™ SX Berm - Black 10 ft. x 45 ft. x 1 ft./3.05 m. x 13.72 m. x 30 cm.	155 lbs./70.3 kg.	3,366 gal./12,742 L	EPA 40 CFR 264.175, SPCC, NPDES
T8435	Talon™ SX Berm - Black 12 ft. x 20 ft. x 1 ft./3.66 m. x 6.09 m. x 30 cm.	130 lbs./59 kg.	1,795 gal./6,795 L	EPA 40 CFR 264.175, SPCC, NPDES
T8436	Talon™ SX Berm - Black 12 ft. x 26 ft. x 1 ft./3.66 m. x 7.92 m. x 30 cm.	140 lbs./63.5 kg.	2,334 gal./8,835 L	N/A
T8437	Talon™ SX Berm - Black 12 ft. x 36 ft. x 1 ft./3.66 m. x 10.97 m. x 30 cm.	165 lbs./74.8 kg.	3,231 gal./12,231 L	EPA
T8438	Talon™ SX Berm - Black 12 ft. x 50 ft. x 1 ft./3.66 m. x 15.24 m. x 30 cm.	250 lbs./113 kg.	4,488 gal./16,989 L	EPA 40 CFR 264.175, SPCC, NPDES
T8439	Talon™ SX Berm - Black 15 ft. x 50 ft. x 1 ft./4.57 m. x 15.24 m. x 30 cm.	268 lbs./122 kg.	5,610 gal./21,236 L	
T8440	Talon™ SX Berm - Black 14 ft. x 54 ft. x 1 ft./4.27 m. x 16.46 m. x 30 cm.	252 lbs./114 kg.	5,654 gal./21,402 L	SPCC COMPLIANT
T8441	Talon™ SX Berm - Black 12 ft. x 60 ft. x 1 ft./3.66 m. x 18.29 m. x 30 cm.	285 lbs./129 kg.	5,385 gal./20,384 L	NPDES
T8442	Talon™ SX Berm - Black 14 ft. x 66 ft. x 1 ft./4.27 m. x 20.12 m. x 30 cm.	337 lbs./153 kg.	6,911 gal./26,161 L	EPA
T8443	Talon™ SX Berm - Black 14 ft. x 85 ft. x 1 ft./4.27 m. x 25.91 m. x 30 cm.	500 lbs./227 kg.	8,901 gal./33,694 L	EPA
T8444	Talon™ SX Berm - Black 20 ft. x 40 ft. x 1 ft./6.09 m. x 12.19 m. x 30 cm.	280 lbs./127 kg.	5,984 gal./22,652 L	EPA 40 CFR 264.175, SPCC, NPDES
T8445	Talon™ SX Berm - Black 20 ft. x 60 ft. x 1 ft./6.09 m. x 4.57 m. x 30 cm.	600 lbs./272 kg.	8,976 gal./33,694 L	EPA 40 CFR 264.175, SPCC, NPDES
T8446	Talon™ SX Berm - Black 25 ft. x 40 ft. x 1 ft./7.62 m. x 12.19 m. x 30 cm.	310 lbs./141 kg.	7,480 gal./28,315 L	EPA 40 CFR 264.175, SPCC, NPDES

Eagle Talon™ SX Berm

The Eagle Talon™ SX Berm features excellent rip, tear and puncture resistance for the most demanding application or terrain. To maintain quality and life of your Talon™ SX Berm, Eagle offers accessories including Ground Pads, Track Mats and Storage Bags. See page 51.

- Ideal for fuel use
- Constructed of XR5 Fabric
- Easy to assemble
- Compact storage and transport
- CAD design and cut components
- Lap joint welds for maximum strength
- Snap-up design permits immediate response
- 30 sizes available
- Made in the USA



Model T8424

Eagle Talon™ SX L-Bracket Berm

- Space saving design
- 2 ft. (61 cm.) wall height
- Quick setup
- Brackets can be mounted inboard or outboard
- Available to match many chemical applications
- Compact shipping and storage

Model No.	Description	Weight	Spill Cap.	Compliance
T8447	Talon™ SX L-Bracket Berm - Black 10 ft. x 10 ft. x 2 ft./3.05 m. x 3.05 m. x 61 cm.	180 lbs. 81.7 kg.	1,496 gal. 5,663 L	EPA 40 CFR 264.175, SPCC, NPDES
T8448	Talon™ SX L-Bracket Berm - Black 15 ft. x 15 ft. x 2 ft./4.57 m. x 4.57 m. x 61 cm.	360 lbs. 163 kg.	3,366 gal. 12,742 L	EPA 40 CFR 264.175, SPCC, NPDES
T8449	Talon™ SX L-Bracket Berm - Black 20 ft. x 20 ft. x 2 ft./6.10 m. x 6.10 m. x 61 cm.	380 lbs. 172 kg.	5,984 gal. 22,652 L	EPA 40 CFR 264.175, SPCC, NPDES



Model No.	Description	Weight	Spill Cap.	Compliance
T8401	Talon™ Spill Berm 4 ft. x 4 ft. x 8 in./1.22 m. x 1.22 m. x 20 cm.	15 lbs./6.8 kg.	80 gal./320 L	EPA 40 CFR 264.175, SPCC, NPDES
T8402	Talon™ Spill Berm 6 ft. x 6 ft. x 8 in./1.83 m. x 1.83 m. x 20 cm.	24 lbs./10.9 kg.	180 gal./480 L	EPA 40 CFR 264.175, SPCC, NPDES
T8403	Talon™ Spill Berm 10 ft. x 10 ft. x 8 in./3.05 m. x 3.05 m. x 20 cm.	36 lbs./16.3 kg.	501 gal./2,004 L	EPA 40 CFR 264.175, SPCC, NPDES
T8404	Talon™ Spill Berm 4 ft. x 6 ft. x 8 in./1.22 m. x 1.83 m. x 20 cm.	18 lbs./8.2 kg.	120 gal./480 L	EPA 40 CFR 264.175, SPCC, NPDES
T8405	Talon™ Spill Berm 4 ft. x 8 ft. x 8 in./1.22 m. x 2.44 m. x 20 cm.	28 lbs./12.7 kg.	160 gal./640 L	EPA 40 CFR 264.175, SPCC, NPDES
T8406	Talon™ Spill Berm 8 ft. x 8 ft. x 8 in./2.44 m. x 2.44 m. x 20 cm.	31 lbs./14.1 kg.	320 gal./1,280 L	EPA 40 CFR 264.175, SPCC, NPDES
T8407	Talon™ Spill Berm 8 ft. x 10 ft. x 8 in./2.44 m. x 3.05 m. x 20 cm.	38 lbs./17.2 kg.	400 gal./1,600 L	EPA 40 CFR 264.175, SPCC, NPDES

Eagle Talon™ Spill Berm

The Eagle Talon™ Spill Berm is a lightweight, portable berm constructed of yellow vinyl-coated polyester. Available in seven sizes.

- Snap-up supports
- Folds for compact storage and transport
- Unique and sturdy supports
- Excellent for decontamination applications
- Great addition to a Spill Kit
- Chemical resistant
- Made in the USA
- Constructed of PVC Coated Fabric



Model T8401

Model No.	Description	Weight	Spill Cap.
T8340	Spill/NEST™ Drip Pad 22 in. x 22 in./56 cm. x 56 cm. (Small)	7 lbs./3.2 kg.	1 gal./3.8 L
T8340RP 5 pack	Spill/NEST™ Drip Pad Replacement Pads (Small)	6 lbs./2.7 kg.	1 gal./3.8 L
T8341	Spill/NEST™ Drip Pad 24 in. x 36 in./61 cm. x 91 cm. (Medium)	8 lbs./3.6 kg.	2 gal./7.6 L
T8341RP 5 pack	Spill/NEST™ Drip Pad Replacement Pads (Medium)	9 lbs./4.1 kg.	2 gal./7.6 L
T8342	Spill/NEST™ Drip Pad 24 in. x 54 in./61 cm. x 137 cm. (Large)	9 lbs./4.1 kg.	3 gal./11.4 L
T8342RP 5 pack	Spill/NEST™ Drip Pad Replacement Pads (Large)	12 lbs./5.4 kg.	3 gal./11.4 L
T8343	Spill/NEST™ Drip Pad 38 in. x 42 in./96 cm. x 107 cm. (X-Large)	9 lbs./4.1 kg.	4 gal./15.1 L
T8343RP 5 pack	Spill/NEST™ Drip Pad Replacement Pads (X-Large)	16.5 lbs./7.5 kg.	4 gal./15.1 L
T8360	Spill/NEST™ XT Off-Road Drip Pad w/ Grommets 3 ft. x 3 ft./91 m. x .91 m.	12 lbs./5.4 kg.	4 gal./15.1 L
T8360RP 5 pack	Spill/NEST™ XT Off-Road Drip Pad Replacement 3 ft. x 3 ft./91 m. x .91 m.	17 lbs./7.7 kg.	4 gal./15.1 L
T8361	Spill/NEST™ XT Off-Road Drip Pad w/ Grommets 3 ft. x 6 ft./91 m. x 1.83 m.	15 lbs./6.8 kg.	10 gal./37.9 L
T8361RP 5 pack	Spill/NEST™ XT Off-Road Drip Pad Replacement 3 ft. x 6 ft./91 m. x 1.83 m.	34 lbs./15.4 kg.	10 gal./37.9 L
T8362	Spill/NEST™ XT Off-Road Drip Pad w/ Grommets 4 ft. x 4 ft./1.22 m. x 1.22 m.	19 lbs./8.6 kg.	8 gal./30.3 L
T8362RP 5 pack	Spill/NEST™ XT Off-Road Drip Pad Replacement 4 ft. x 4 ft./1.22 m. x 1.22 m.	32 lbs./14.5 kg.	8 gal./30.3 L
T8363	Spill/NEST™ XT Off-Road Drip Pad w/ Grommets 4 ft. x 5 ft./1.22 m. x 1.52 m.	21 lbs./9.5 kg.	12 gal./45.4 L
T8363RP 5 pack	Spill/NEST™ XT Off-Road Drip Pad Replacement 4 ft. x 5 ft./1.22 m. x 1.52 m.	35 lbs./15.9 kg.	12 gal./45.4 L

Eagle Spill/NEST™ Drip Pads

Eagle Spill/NEST™ Drip Pads are used for leaks. Designed to be used as a durable, portable drip pad. Made in the USA.

- Each unit folds easily
- Refill pads are available in packs of 5



Model T8340

Model T8341

Model T8342

FLEXIBLE CONTAINMENT



Eagle Talon™ Drive-In & Drive-Out

The Eagle Talon™ Drive-In and Drive-Out Spill Berm allows the user to drive in and out without having to lower the end walls. Fuel and chemical resistant.

- Ideal for fuel use
- Constructed of XR5 Fabric
- Easy to assemble
- Lap joint welds for maximum strength
- Design permits quick deployment
- Additional sizes available
- Made in the USA



Model T8430DR
Shown with Ground Pad,
Track Mat and Tie Down Straps



Ground Pads and Track Mats are available for additional protection. See page 51.



Model No.	Description	Weight	Spill Capacity	Compliance
T8430DR	Talon™ Drive-In & Drive-Out Berm 12 ft. x 18 ft. x 1 ft./3.66 m. x 5.49 m. x 30 cm.	120 lbs. 54.4 kg.	1,615 gal. 6,113 L	N/A
T8432DR	Talon™ Drive-In & Drive-Out Berm 10 ft. x 26 ft. x 1 ft./3.05 m. x 7.92 m. x 30 cm.	142 lbs. 64.4 kg.	1,944 gal. 7,359 L	
T8437DR	Talon™ Drive-In & Drive-Out Berm 12 ft. x 36 ft. x 1 ft./3.66 m. x 10.97 m. x 30 cm.	198 lbs. 89.8 kg.	3,231 gal. 12,231 L	SPCC COMPLIANT
T8440DR	Talon™ Drive-In & Drive-Out Berm 14 ft. x 54 ft. x 1 ft./4.27 m. x 16.46 m. x 30 cm.	252 lbs. 114.3 kg.	5,654 gal. 21,403 L	NPDES EPA
T8441DR	Talon™ Drive-In & Drive-Out Berm 12 ft. x 60 ft. x 1 ft./3.66 m. x 18.29 m. x 30 cm.	293 lbs. 132.9 kg.	5,385 gal. 20,384 L	EPA
T8443DR	Talon™ Drive-In & Drive-Out Berm 14 ft. x 85 ft. x 1 ft./4.27 m. x 25.91 m. x 30 cm.	475 lbs. 215.5 kg.	8,901 gal. 33,694 L	

Eagle SpillNEST™ Rail Containment

Eagle SpillNEST™ Rail Containment provides portable spill containment and control for bottom loading and unloading rail tank cars. The lightweight containment berm (80 lbs./36.29 kg.) is designed to provide a temporary berm containment area around the valves below a rail tank car.



Model T8610

Eagle SpillNEST™ Containment Pools

The Eagle SpillNEST™ Containment Pool offers excellent resistance to the widest range of chemicals, acids, fuels and other hazardous materials. This lightweight design is durable and fits easily into spill response kits.

Model No.	Description	Capacity	Color	Compliance	Model No.	Description	Color	Weight	Compliance
T8460RB	SpillNEST™ Rail Berm 4 ft. x 6 ft. x 1 ft./ 1.22 m. x 1.83 m. x 30 cm.	120 gal. 454.25 L	Black	SPCC COMPLIANT NPDES EPA	T8610	20 gal./75.7 L SpillNEST™ Pool	Yellow	2 lbs./9 kg.	SPCC COMPLIANT
T847ORM	Rail Containment Mats Interior: 56 in. x 35 ft., Exterior: 16 in. x 35 ft.		Black	EPA	T8611	66 gal./249 L SpillNEST™ Pool	Yellow	4 lbs./1.8 kg.	NPDES EPA
					T8601	100 gal./379 L SpillNEST™ Pool	Yellow	4 lbs./1.8 kg.	EPA
					T8612	150 gal./568 L SpillNEST™ Pool	Yellow	5 lbs./2.3 kg.	



DripNEST™ Hose Wraps



Model T8381

The Eagle DripNEST™ Hose Wraps are made of durable and chemically resistant materials with an integrated sorbent pad. The Hose Wrap can absorb leaks from hoses and fittings from 2 in. to 10 in. (5 cm. x 24 cm.) in size.

Model No.	Description	Color	Weight	Compliance
T8381	25 oz. DripNEST™ Hose Wrap 2 in. - 3 in./5 cm. - 8 cm.	Yellow	8 oz. .23 kg.	
T8382	25 oz. DripNEST™ Hose Wrap 4 in. - 5 in./10 cm. - 13 cm.	Yellow	1 lb. .45 kg.	
T8383	25 oz. DripNEST™ Hose Wrap 6 in. - 8 in./15 cm. - 20 cm.	Yellow	1 lb. .45 kg.	
T8384	25 oz. DripNEST™ Hose Wrap 10 in./25.4 cm.	Yellow	3 lbs. 1.4 kg.	

DripNEST™ Maintenance Blanket



The Eagle DripNEST™ Maintenance Blanket is designed to be used under vehicles or leaking equipment. Made of a non-woven geo-textile that is backed by a layer of furl/chemical-resistant polyethylene. The blanket provides a protective sorbent pad between the maintenance item and placement area. Can be rolled or folded into a compact lightweight unit. (See image on pg. 55.)

Model No.	Description	Color	Weight	Compliance
T8390	DripNEST™ Maintenance Blanket 3 ft. x 12 ft./122 cm. x 365 cm.	Y/BLK	5 lbs./ 2.3 kg.	
T8391	DripNEST™ Maintenance Blanket 6 ft. x 12 ft./183 cm. x 365 cm.	Y/BLK	11 lbs./ 5.0 kg.	
T8392	DripNEST™ Maintenance Blanket 9 ft. x 12 ft./244 cm. x 365 cm.	Y/BLK	16 lbs./ 7.3 kg.	
T8393	DripNEST™ Maintenance Blanket 12 ft. x 12 ft./365 cm. x 365 cm.	Y/BLK	21 lbs./ 9.5 kg.	

Eagle SpillNEST™ Decon Pools

The Eagle SpillNEST™ Decon Pool is an inexpensive and quick deployment pool that is small enough to be stored on any truck or emergency response vehicle. (For reuse or discard according to regulations).

The Eagle SpillNEST™ Decon Pool has an excellent puncture, abrasion and chemical resistance along with -60°F cold crack resistance. This lightweight design is resistant to a wide range of chemicals, is 8 in. (20.32 cm.) tall and only takes seconds to set up. (Optional drain)



Model T8602

Model No.	Description	Color	Weight	Compliance
T8602	100-Gallon (378.5 L) SpillNEST™ Decon Pool	Yellow	5 lbs./2.3 kg.	EPA 40 CFR 264.175, SPCC, NPDES
T8602D	100-Gallon (378.5 L) SpillNEST™ Decon Pool with drain	Yellow	5 lbs./2.3 kg.	EPA 40 CFR 264.175, SPCC, NPDES

DripNEST™ Hose Bibbs

Model T8380



The Eagle DripNEST™ Hose Bibb safely wraps quick-disconnect fittings or other hose attachment ends to absorb small leaks when disconnecting hoses from industrial equipment. Integrated internal sorbent allows for containment of up to 1 pint of oil, hydraulic fluid or other hydrocarbons.

Model No.	Description	Color	Weight	Compliance
T8380	DripNEST™ Hose Bibb	Yellow	8 oz. 237 mL.	
T8380BX	DripNEST™ Hose Bibb (5 pack)	Yellow	8 oz. 237 mL. (5)	

Eagle DripNEST™ Leak Diverter

Eagle DripNEST™ Leak Diverters provide an instant drip diversion. Available in various sizes, this funnel style diverter will channel away liquids to minimize the risk of injuries, property damage and contamination. Flow rate: 3 gal. per minute. Includes a garden hose connector with cap for easy set up. Made in the USA.

Model No.	Description	Color	Weight
T8301	DripNEST™ Leak Diverter 3 ft. x 3 ft./91 cm. x 91 cm.	Yellow	2 lbs./9 kg.
T8302	DripNEST™ Leak Diverter 3 ft. x 6 ft./91 cm. x 183 cm.	Yellow	3.5 lbs./1.6 kg.
T8303	DripNEST™ Leak Diverter 3 ft. x 10 ft./91 cm. x 304 cm.	Yellow	5 lbs./2.3 kg.
T8304	DripNEST™ Leak Diverter 5 ft. x 5 ft./152 cm. x 152 cm.	Yellow	4 lbs./1.8 kg.
T8305	DripNEST™ Leak Diverter 6 ft. x 6 ft./183 cm. x 183 cm.	Yellow	5 lbs./2.3 kg.
T8306	DripNEST™ Leak Diverter 6 ft. x 10 ft./183 cm. x 304 cm..	Yellow	7 lbs./3.2 kg.
T8307	DripNEST™ Leak Diverter 6 ft. x 12 ft./183 cm. x 366 cm.	Yellow	9 lbs./4.1 kg.
T8308	DripNEST™ Leak Diverter 10 ft. x 12 ft./304 cm. x 366 cm.	Yellow	9 lbs./4.1 kg.
T8309	DripNEST™ Leak Diverter 12 ft. x 12 ft./366 cm. x 366 cm.	Yellow	10 lbs./4.5 kg.
T8310	DripNEST™ Leak Diverter 12 ft. x 20 ft./366 cm. x 610 cm.	Yellow	13.5 lbs./6.1 kg.
T8311	DripNEST™ Leak Diverter 18 ft. x 18 ft./549 cm. x 549 cm.	Yellow	14 lbs./6.4 kg.
T8312	DripNEST™ Leak Diverter 24 ft. x 24 ft./732 cm. x 732 cm.	Yellow	15 lbs./6.8 kg.

Model T8301



FLEXIBLE CONTAINMENT



Model T8702B

Eagle StormNEST™ Storm Water Control Basin Inserts

The Eagle StormNEST™ Storm Water Control adjustable catch basin inserts to help with NPDES, 40 CFR 122.26 compliance of Stormwater Pollution Prevention Plans when used as Best Management Practices. Designed to protect storm drains and sewers from debris and sediments. Available with or without oil-absorbent bag. Made in the USA.

- Available in rectangular or round designs
- Rectangular models designed to fit catch basins from 16 in. x 20 in. to 42 in. x 42 in.
- Round model designs fit catch basins from 27 in. to 29 in. in diameter
- All models available with or without oil-absorbent feature
- Requires no special tools to install and remove
- Overflow rate of up to 500 gpm helps avoid ponding

Model No.	Description	Weight	Compliance
T8701	500 gpm Basin Insert-Sediment, Round Adjustable 24 in. - 26 in./61 cm. - 66 cm. - Black	2 lbs./.9 kg.	 Helps With NPDES, 40 CFR 122.26
T8701B	500 gpm Catch Basin Insert - Sediment-Oils, Round 24 in. - 26 in./61 cm. - 66 cm. - Black	2 lbs./.9 kg.	
T8702	500 gpm Catch Basin Insert - Rectangle Adjustable 16 in. x 20 in./41 cm. x 51 cm. to 28 in. x 38 in./71 cm. x 96 cm. - Black	2 lbs./.9 kg.	
T8702B	500 gpm Catch Basin Insert - Sediment-Oils, Rectangle Adjustable 16 in. x 20 in./41 cm. x 51 cm., 28 in. x 38 in./71 cm. x 96 cm. - Black	2 lbs./.9 kg.	
T8702XL	500 gpm Catch Basin Insert - Sediment, Rectangle XL Adjustable 25 in. - 42 in./63.5 cm. - 107 cm. - Black	3 lbs./1.4 kg.	
T8702XLB	500 gpm Catch Basin Insert - Sediment-Oils, Rectangle XL 25 in. - 42 in./63.5 cm. - 107 cm. - Black	3 lbs./1.4 kg.	
T8711	500 gpm Drain Dam (2/Pkg) - Black	6 lbs./2.7 kg.	 Helps With NPDES, 40 CFR 122.26
T8712	500 gpm Curb Inlet Insert - Sediment - Black	3 lbs./1.4 kg.	
T8713	500 gpm Inlet Insert - Sediment No Frame 36 in. x 48 in./91 cm. x 122 cm. - Black	2 lbs./.9 kg.	 Helps With NPDES, 40 CFR 122.26
T8713B	500 gpm Inlet Insert - Sediment-Oils No Frame 36 in. x 48 in./91 cm. x 122 cm. - Black	2 lbs./.9 kg.	
T8714	500 gpm Inlet Insert - Sediment No Frame 60 in. x 60 in./152 cm. x 152 cm. - Black	3 lbs./1.4 kg.	
T8714B	500 gpm Inlet Insert - Sediment-Oils No Frame 60 in. x 60 in./152 cm. x 152 cm. - Black	3 lbs./1.4 kg.	



Model T8701



Model T8702B

Eagle Drain Covers

Eagle Drain Covers are durable and chemically resistant. Drain Covers help create a barrier helping to prevent liquids from reaching the drain.

- Available in four sizes
- Easy to use
- Easy to clean
- Reusable
- 100 percent Polyurethane Elastomer

Model No.	Description	Color	Weight	Compliance
T8721	Drain Cover 18 in. x 18 in./46 cm. x 46 cm.	Red	7 lbs./3.2 kg.	
T8722	Drain Cover 24 in. x 24 in./61 cm. x 61 cm.	Red	10 lbs./4.5 kg.	
T8723	Drain Cover 36 in. x 36 in./91 cm. x 91 cm.	Red	15 lbs./6.8 kg.	
T8724	Drain Cover 48 in. x 48 in./122 cm. x 122 cm.	Red	19 lbs./8.6 kg.	

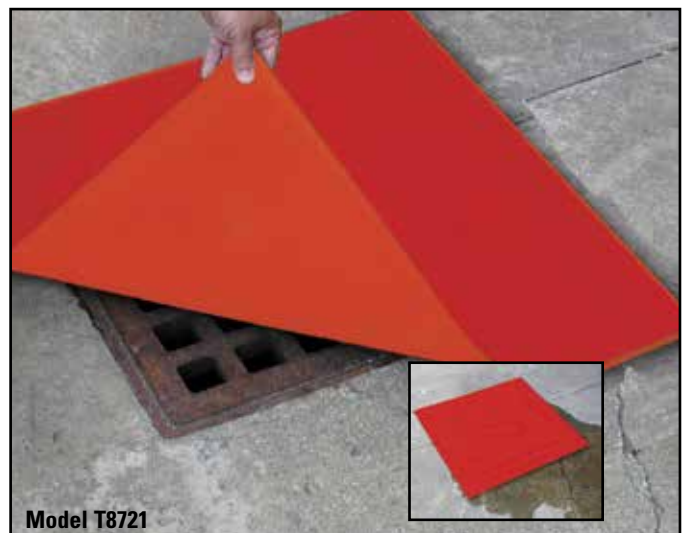

Model T8721



BERM ACCESSORIES



Berm Repair Kits

Fix or repair your damaged berm with a Berm Repair Kit. Standard option is available for a quick-fix or Deluxe for everything needed to get your job back up and running.

Hose Bridge

Connect containment sumps without damaging sidewalls with the convenient hose bridge.

BERM REPAIR KIT

Model	Description	Ship Weight
82-BRK	Berm Repair Kit - Black	1 lb./,45 kg.
82-BRKD-12	Deluxe Berm Repair Kit -12 in./30 cm. - Black	15 lbs./6.8 kg.
82-BRKD-8	Deluxe Berm Repair Kit - 8 in./20 cm. - Black	15 lbs./6.8 kg.

HOSE BRIDGE

Model	Description	Ship Weight
82-BRIDGE	Hose Bridge	38 lbs./17.2 kg.

TRACK MATS



Track Mats for the Eagle Talon™ Series Berms

When used inside the Eagle Talon™ Series Berms, this mat allows trucks to drive in and drive out while helping protect the berm from punctures and tears. Available in sizes to match 6 ft. x 6 ft. (1.82 m. x 1.82 m.) and larger Eagle Talon™ Berms.

Model	Description	Ship Weight	Compliance
T8427TM	Track Mat For 6 ft. x 6 ft./1.83 m. x 1.83 m. Berm - Black	24 lbs./10.9 kg.	
T8429TM	Track Mat For 10 ft. x 10 ft./3.05 m. x 3.05 m. Berm - Black	40 lbs./18.1 kg.	
T8430TM	Track Mat For 12 ft. x 12 ft./3.66 m. x 3.66 m. Berm - Black	48 lbs./21.8 kg.	
T8431TM	Track Mat For 16 ft. x 16 ft./4.88 m. x 4.88 m. Berm - Black	64 lbs./29.0 kg.	
T8432TM	Track Mat For 10 ft. x 26 ft./3.05 m. x 7.92 m. Berm - Black	84 lbs./38.1 kg.	
T8437TM	Track Mat For 12 ft. x 36 ft./3.66 m. x 10.97 m. Berm (2, 3 ft. x 36 ft.) - Black	144 lbs./65.3 kg.	
T8439TM	Track Mat For 15 ft. x 50 ft./4.57 m. x 15.24 m. Berm (2, 3 ft. x 50 ft.) - Black	200 lbs./90.7 kg.	
T8440TM	Track Mat For 14 ft. x 54 ft./4.27 m. x 16.46 m. Berm (2, 3 ft. x 54 ft.) - Black	216 lbs./98.0 kg.	
T8441TM	Track Mat For 12 ft. x 60 ft./3.66 m. x 18.29 m. Berm (2, 3 ft. x 60 ft.) - Black	223 lbs./101 kg.	
T8442TM	Track Mat For 14 ft. x 66 ft./4.27 m. x 20.17 m. Berm (2, 3 ft. x 66 ft.) - Black	263 lbs./119 kg.	
T8443TM	Track Mat For 14 ft. x 85 ft./4.27 m. x 25.91 m. Berm (2, 3 ft. x 85 ft.) - Black	340 lbs./154 kg.	



Storage and Transport Bag

Heavy duty, durable and chemical-resistant storage and transport bag for ease and storage of Eagle Talon™ Berms.

STORAGE AND TRANSPORT BAGS

Model	Description	Ship Weight	Compliance
T8429BAG	Storage & Transport Bag - Up To 10 ft. x 10 ft./3.05 m. x 3.05 m. - Black	15 lbs./6.8 kg.	
T8431BAG	Storage & Transport Bag - Up To 16 ft. x 16 ft./4.88 m. x 4.88 m. - Black	15 lbs./6.8 kg.	
T8432BAG	Storage & Transport Bag - Up To 10 ft. x 26 ft./3.05 m. x 7.92 m. - Black	17 lbs./7.7 kg.	
T8437BAG	Storage & Transport Bag - Up To 12 ft. x 36 ft./3.66 m. x 10.97 m. - Black	21 lbs./9.5 kg.	
T8440BAG	Storage & Transport Bag - Up To 14 ft. x 54 ft./4.27 m. x 16.46 m. - Black	27 lbs./12.2 kg.	



Ground Pad

When used under the Eagle Talon™ Series Berms, the ground pad helps protect berms from truck wheels and rough terrain. Place directly on the ground under the Eagle Talon™ Berm to guard against underside punctures.

GROUND PADS

Model	Description	Ship Weight
T8424GP	Ground Pad For 4 ft. x 6 ft./1.21 m. x 1.83 m. Berm - Black	5 lbs./2.3 kg.
T8427GP	Ground Pad For 6 ft. x 6 ft./1.82 m. x 1.83 m. Berm - Black	22 lbs./10 kg.
T8429GP	Ground Pad For 10 ft. x 10 ft./3.05 m. x 3.05 m. Berm - Black	38 lbs./17.2 kg.
T8430GP	Ground Pad For 12 ft. x 12 ft./3.66 m. x 3.66 m. Berm - Black	30 lbs./13.6 kg.
T8431GP	Ground Pad For 16 ft. x 16 ft./4.88 m. x 4.87 m. Berm - Black	55 lbs./24.9 kg.
T8432GP	Ground Pad For 10 ft. x 26 ft./3.05 m. x 7.92 m. Berm - Black	57 lbs./25.9 kg.
T8437GP	Ground Pad For 12 ft. x 36 ft./3.66 m. x 10.97 m. Berm - Black	92 lbs./41.7 kg.
T8439GP	Ground Pad For 15 ft. x 50 ft./4.57 m. x 15.24 m. Berm - Black	104 lbs./47.2 kg.
T8440GP	Ground Pad For 14 ft. x 54 ft./4.27 m. x 16.45 m. Berm - Black	124 lbs./56.2 kg.
T8441GP	Ground Pad For 12 ft. x 60 ft./3.66 m. x 18.29 m. Berm - Black	124 lbs./56.2 kg.
T8442GP	Ground Pad For 14 ft. x 66 ft./4.27 m. x 20.17 m. Berm - Black	140 lbs./63.5 kg.
T8443GP	Ground Pad For 14 ft. x 85 ft./4.27 m. x 25.91 m. Berm - Black	260 lbs./117.9 kg.



POLY DRUMS

For nearly 30 years, Eagle Manufacturing's ever-growing Poly Drum product line has handled both hazardous and non-hazardous storage needs for customers by offering Lab Packs, Overpacks, Open-Head and Salvage Drums. The 14- (53 L), 20- (75.7 L), 30- (113.6 L) and 55-gallon (208.2 L) Lab Packs and Open-Head Drums are available with plastic lids and a choice of metal or plastic lever locking rings. The 14- (53 L), 20- (75.7 L), 30- (113.6 L), 55- (208.2 L), 65- (246.1 L) and 95-gallon (359.6 L) Overpack and Salvage Drums are available with metal bands or screw-on lids. All models are constructed of chemical resistant, high-density polyethylene (HDPE) with UV inhibitors, are durable and lightweight and available in yellow, blue and black. All of our products are 100 percent made in the USA.

All drums feature:

- Blow-molded HDPE construction
- Chemical & weather resistant
- HDPE incinerates completely
- United Nations (UN) Certified to HM-181
- Operating temperature range (-40° F/-34° C to 140° F/54° C)
- Drop tested – max weight at 0° F/-17° C (48 hrs.)
- Approved for use with Packing Groups I, II and III
- UV Protection Package
- UL 94HB Flammability Rating
- Nestable for ideal storage (except model 1656)
- FDA 21 CFR 177.1520 Food Grade Quality
- Stack tested – three high at maximum weight capacity (24 hrs.)

Eagle drums are ideal for:

- Safe storage, handling and transportation of hazardous materials
- Spill containment and cleanup of hazardous materials
- Spill kit containers
- Original shipping containers
- Biowaste disposal and incineration



POLY DRUMS



10 GALLON DRUMS

	CLASSIC BAND			METAL BAND		BOLT BAND
Model Numbers	1609	1609BLK	1609B	1609M	1609MB	1609MBBR
Style	Lab Pack Open Head Drum	Lab Pack Open Head Drum	Lab Pack Open Head Drum	Lab Pack Open Head Drum	Lab Pack Open Head Drum	Lab Pack Open Head Drum
Closure Type	Plastic Band	Plastic Band	Plastic Band	Metal Band	Metal Band	Metal Bolt Ring
Inside Dimensions <small>Top: Bottom: Height:</small>	14 $\frac{1}{8}$ in./35.9 cm. 12 $\frac{3}{8}$ in./31.4 cm. 18 in./45.7 cm.	14 $\frac{1}{8}$ in./35.9 cm. 12 $\frac{3}{8}$ in./31.4 cm. 18 in./45.7 cm.	14 $\frac{1}{8}$ in./35.9 cm. 12 $\frac{3}{8}$ in./31.4 cm. 18 in./45.7 cm.	14 $\frac{1}{8}$ in./35.9 cm. 12 $\frac{3}{8}$ in./31.4 cm. 18 in./45.7 cm.	14 $\frac{1}{8}$ in./35.9 cm. 12 $\frac{3}{8}$ in./31.4 cm. 18 in./45.7 cm.	14 $\frac{1}{8}$ in./35.9 cm. 12 $\frac{3}{8}$ in./31.4 cm. 18 in./45.7 cm.
Outside Dimensions <small>Top: Bottom: Height:</small>	15 in./38.1 cm. 12 $\frac{3}{4}$ in./32.4 cm. 18 $\frac{1}{2}$ in./46.5 cm.	15 in./38.1 cm. 12 $\frac{3}{4}$ in./32.4 cm. 18 $\frac{1}{2}$ in./46.5 cm.	15 in./38.1 cm. 12 $\frac{3}{4}$ in./32.4 cm. 18 $\frac{1}{2}$ in./46.5 cm.	15 in./38.1 cm. 12 $\frac{3}{4}$ in./32.4 cm. 18 $\frac{1}{2}$ in./46.5 cm.	15 in./38.1 cm. 12 $\frac{3}{4}$ in./32.4 cm. 18 $\frac{1}{2}$ in./46.5 cm.	15 in./38.1 cm. 12 $\frac{3}{4}$ in./32.4 cm. 18 $\frac{1}{2}$ in./46.5 cm.
Maximum Capacity	133 lbs. 60 kg.	133 lbs. 60 kg.	133 lbs. 60 kg.	133 lbs. 60 kg.	133 lbs. 60 kg.	133 lbs. 60 kg.
Total Capacity	10 gal. 38 L	10 gal. 38 L	10 gal. 38 L	10 gal. 38 L	10 gal. 38 L	10 gal. 38 L
Maximum Container Size <small>(If used as an overpack drum)</small>	5 gal. 18.9 L	5 gal. 18.9 L	16 gal. 60.6 L	16 gal. 60.6 L	16 gal. 60.6 L	30 gal. 113.6 L
Weight	7.5 lbs. 3.4 kg.	7.5 lbs. 3.4 kg.	7.5 lbs. 3.4 kg.	7.5 lbs. 3.4 kg.	7.5 lbs. 3.4 kg.	7.5 lbs. 3.4 kg.
Pallet Quantity	81	81	81	81	81	81
Truckload Quantity	1,404	1,404	1,404	1,404	1,404	1,404
UN/DOT Rating	1H2/Y60/S	1H2/Y60/S	1H2/Y60/S	1H2/X60/S 1H2/Y75/S	1H2/X60/S 1H2/Y75/S	1H2/X60/S 1H2/Y75/S



Eagle 10-Gallon Poly Drum

Eagle's NEW 10 Gallon Lab Pack / Open Head Drum is blow molded with durable high-density polyethylene (HDPE) for maximum performance and quality. The HDPE is chemical and weather resistant and includes a UV protection package. Available in Yellow, Blue, Black or Natural HDPE, with plastic or metal lever lock, or metal bolt ring. 100% Made in the USA.

Features:

- Constructed of durable HDPE
- Nestable storage to optimize shipping and storage space
- Plastic or Metal Lever Locking Bands
- FDA 21 CFR 177.1520 Food Grade Quality
- Operating Temp range (-30° F to 130° F)
- Drop tested-max weight @ 0° F (48hrs)
- UL 94HB Flammability Rating

POLY DRUMS

14 GALLON DRUMS

BUNG LID / BOLT RING OPTIONS Available for some models

NEW! NATURAL COLORS Available for All Banded Drums



100% Recyclable



Model Numbers Bung Lid Models	1610	1610BLK	1610M 1610M-BGI	1610MB 1610MB-BGI	1610MBLK 1610MBK-BGI
Style	Lab Pack Open Head Drum	Lab Pack Open Head Drum	Lab Pack Open Head Drum	Lab Pack Open Head Drum	Lab Pack Open Head Drum
Closure Type	Plastic Lever-Lock	Plastic Lever-Lock	Metal Lever-Lock	Metal Lever-Lock	Metal Lever-Lock
Inside Dimensions Top: Bottom: Height:	13½ in./34.3 cm. 12¾ in./31.4 cm. 25 in./63.5 cm.	13½ in./34.3 cm. 12¾ in./31.4 cm. 25 in./63.5 cm.	13½ in./34.3 cm. 12¾ in./31.4 cm. 25 in./63.5 cm.	13½ in./34.3 cm. 12¾ in./31.4 cm. 25 in./63.5 cm.	13½ in./34.3 cm. 12¾ in./31.4 cm. 25 in./63.5 cm.
Outside Dimensions Top: Bottom: Height:	15 in./38.1 cm. 12¾ in./32.4 cm. 26½ in./67.3 cm.	15 in./38.1 cm. 12¾ in./32.4 cm. 26½ in./67.3 cm.	15 in./38.1 cm. 12¾ in./32.4 cm. 26½ in./67.3 cm.	15 in./38.1 cm. 12¾ in./32.4 cm. 26½ in./67.3 cm.	15 in./38.1 cm. 12¾ in./32.4 cm. 26½ in./67.3 cm.
Maximum Capacity	143 lbs. 65 kg.	143 lbs. 65 kg.	220 lbs. 100 kg.	220 lbs. 100 kg.	220 lbs. 100 kg.
Total Capacity	14 gal. 52.2 L	14 gal. 52.2 L	14 gal. 52.2 L	14 gal. 52.2 L	14 gal. 52.2 L
Maximum Container Size (If used as an overpack drum)	5 gal. 18.9 L	5 gal. 18.9 L	5 gal. 18.9 L	5 gal. 18.9 L	5 gal. 18.9 L
Weight	9 lbs. 3.6 kg.	9 lbs. 3.6 kg.	10 lbs. 4.1 kg.	10 lbs. 4.1 kg.	10 lbs. 4.1 kg.
Pallet Quantity	54	54	54	54	54
Truckload Quantity	1,188	1,188	1,188	1,188	1,188
UN/DOT Rating	1H2/X65/S 1H2/Y100/S	1H2/X65/S 1H2/Y100/S	1H2/X65/S 1H2/Y100/S	1H2/X65/S 1H2/Y100/S	1H2/X65/S 1H2/Y100/S



Lab Packs/Open Head - for use with smaller non-damaged bottles, cans, carboys and 5-gallon (18.9 L) pails of non-leaking hazardous materials – if leaking, must pack with sufficient sorbents – NO FREE LIQUIDS.





Salvage Drums - for use with damaged or leaking containers of hazardous materials or used absorbent materials contaminated with a hazardous substance. Require "Salvage Drum" labeling and must pass a 3-PSI pressure test.

Regulatory Compliance:

Lab Packs/Open Head: DOT 49 CFR 173.12 / Overpacks: DOT 49 CFR 173.25
Salvage Drums: DOT 49 CFR 173.3



20 GALLON DRUMS

				
1652	1654	1623	1623BLK	1623M
Lab Pack	Salvage Drum	Lab Pack Open Head Drum	Lab Pack Open Head Drum	Lab Pack Open Head Drum
Plastic Lever-Lock	Metal Lever-Lock	Plastic Lever-Lock	Plastic Lever-Lock	Metal Lever-Lock
19 in./48.3 cm. 16 ¹ / ₁₆ in./41.4 cm. 19 in./48.3 cm.	19 in./48.3 cm. 16 ¹ / ₁₆ in./41.4 cm. 19 in./48.3 cm.	15 ¹ / ₂ in./39 cm. 12 ¹ / ₂ in./32.7 cm. 29 ¹ / ₂ in./75.9 cm.	15 ¹ / ₂ in./39 cm. 12 ¹ / ₂ in./32.7 cm. 29 ¹ / ₂ in./75.9 cm.	15 ¹ / ₂ in./39 cm. 12 ¹ / ₂ in./32.7 cm. 29 ¹ / ₂ in./75.9 cm.
20 ¹ / ₁₆ in./53 cm. 16 ¹ / ₁₆ in./42.4 cm. 20 ¹ / ₁₆ in./51.9 cm.	20 ¹ / ₁₆ in./53 cm. 16 ¹ / ₁₆ in./42.4 cm. 20 ¹ / ₁₆ in./51.9 cm.	15 ¹ / ₂ in./40 cm. 13 ³ / ₄ in./33.7 cm. 30 ¹ / ₂ in./77.5 cm.	15 ¹ / ₂ in./40 cm. 13 ³ / ₄ in./33.7 cm. 30 ¹ / ₂ in./77.5 cm.	15 ¹ / ₂ in./40 cm. 13 ³ / ₄ in./33.7 cm. 30 ¹ / ₂ in./77.5 cm.
88 lbs. 40 kg.	165 lbs. 75 kg.	220 lbs. 100 kg.	220 lbs. 100 kg.	220 lbs. 100 kg.
20 gal. 77 L	20 gal. 77 L	20 gal. 77 L	20 gal. 77 L	20 gal. 77 L
5 gal. 18.9 L	5 gal. 18.9 L	5 gal. 18.9 L	5 gal. 18.9 L	5 gal. 18.9 L
15 lbs. 5.85 kg.	16 lbs. 6.75 kg.	10.25 lbs. 4.65 kg.	10.25 lbs. 4.65 kg.	11.5 lbs. 5.2 kg.
40	40	42	42	42
1,000	1,000	1,092	1,092	1,092
1H2/X40/S	1H2/X75/S	1H2/X75/S 1H2/Y100/S	1H2/X75/S 1H2/Y100/S	1H2/X75/S 1H2/Y100/S

Overpacks - for use with larger non-damaged containers, cans and drums of non-leaking hazardous materials – if leaking, must pack with sufficient sorbents – **NO FREE LIQUIDS.**

UN Markings: UN 1H2/X340/S/96USA/M4990
 1- Type of Container (drum), H-material of construction (plastic), 2- Removable head/X-Testing performance (X=Groups I, II, & III), 340-Max. Wt. of Container (Kg)S-solids/96/Year of Manufacture, USA-State Authorization Mark/M - certification compliance, 4990 -Testing Agency number.



POLY DRUMS

20 GALLON DRUMS

BUNG LID / BOLT RING OPTIONS Available for 30 Gallon Eagle Models

NEW! NATURAL COLORS

Available for



HDPE

100% Recyclable



Model Numbers Bung Lid Models	1623MB	1623MBLK	1601	1601BLK 1601BLK-BG	1601M 1601M-BG2 or 1601BLK-BRBG2
Style	Lab Pack Open Head Drum	Lab Pack Open Head Drum	Lab Pack Open Head Drum	Lab Pack Open Head Drum	Lab Pack Open Head Drum
Closure Type	Metal Lever-Lock	Metal Lever-Lock	Plastic Lever-Lock	Plastic Lever-Lock	Metal Lever-Lock
Inside Dimensions Top: Bottom: Height:	15½ in./39 cm. 12¾ in./32.7 cm. 29¾ in./75.9 cm.	15½ in./39 cm. 12¾ in./32.7 cm. 29¾ in./75.9 cm.	19 in./48.3 cm. 16¼ in./41.3 cm. 26¾ in./67 cm.	19 in./48.3 cm. 16¼ in./41.3 cm. 26¾ in./67 cm.	19 in./48.3 cm. 16¼ in./41.3 cm. 26¾ in./67 cm.
Outside Dimensions Top: Bottom: Height:	15¼ in./40 cm. 13¼ in./33.7 cm. 30½ in./77.5 cm.	15¼ in./40 cm. 13¼ in./33.7 cm. 30½ in./77.5 cm.	21½ in./54 cm. 16¾ in./42.2 cm. 28½ in./72.4 cm.	21½ in./54 cm. 16¾ in./42.2 cm. 28½ in./72.4 cm.	21½ in./54 cm. 16¾ in./42.2 cm. 28½ in./72.4 cm.
Maximum Capacity	220 lbs. 100 kg.	220 lbs. 100 kg.	220 lbs. 100 kg.	220 lbs. 100 kg.	396 lbs. 180 kg.
Total Capacity	20 gal. 77 L	20 gal. 77 L	30 gal. 114 L	30 gal. 114 L	30 gal. 114 L
Maximum Container Size (If used as an overpack drum)	5 gal. 18.9 L	5 gal. 18.9 L	16 gal. 60.6 L	16 gal. 60.6 L	16 gal. 60.6 L
Weight	11.5 lbs. 5.7 kg.	11.5 lbs. 5.2 kg.	16 lbs. 6.3 kg.	18 lbs. 7.2 kg.	18 lbs. 7.2 kg.
Pallet Quantity	42	42	40	40	40
Truckload Quantity	1,092	1,092	1,000	1,000	1,000
UN/DOT Rating	1H2/X75/S 1H2/Y100/S	1H2/X75/S 1H2/Y100/S	1H2/X100/S 1H2/Y180/S	1H2/X100/S 1H2/Y180/S	1H2/X120/S 1H2/Y180/S

Benefits of Blow-Molded HDPE Drums

HDPE is a very high molecular weight material, designed for an optimum balance of density, molecular weight and molecular weight distribution, demonstrating maximum property advantages for large products that require high impact resistance. Some of these advantages include:

- Environmental stress crack resistance (ESCR)
- Impact strength – even at a low temperature

- Flexural modulus – durability and resilience
- Chemical resistance – to wide range of chemicals
- Abrasion resistance – prevents gouging and scuffing
- Ultraviolet (UV) protection – superior blending process
- Plain Lid with gasket to seal lid to drum with drum lever ring (lever rings come in powder-coated metal or HDPE plastic)
- Lid with Two 2 in. (5.08 cm.) bung lids for drum pump straight thread connections
- Lid with one 2 in. (5.08 cm.) and one 3/4 in. (1.9 cm.) for drum pump straight thread connections





30 GALLON DRUMS

55 GALLON DRUMS

All Banded Drums



1601MB 1601MB-BBG or 1601MB-BG2	1601MBLK 1601MBLK-BG or 1601MBK-BG2	1602	1655	1655BLK
Lab Pack Open Head Drum	Lab Pack Open Head Drum	Salvage Drum	Lab Pack Open Head Drum	Lab Pack Open Head Drum
Metal Lever-Lock	Metal Lever-Lock	Metal Lever-Lock	Plastic Lever-Lock	Plastic Lever-Lock
19 in./48.5 cm. 16¼ in./41.3 cm. 26½ in./67 cm.	19 in./48.5 cm. 16¼ in./41.3 cm. 26½ in./67 cm.	19 in./48.5 cm. 16¼ in./41.3 cm. 26½ in./67 cm.	22⅞ in./58.1 cm. 19 in./48.3 cm. 38⅞ in./98 cm.	22⅞ in./58.1 cm. 19 in./48.3 cm. 38⅞ in./98 cm.
21⅞ in./54 cm. 16⅝ in./42.2 cm. 28½ in./72.4 cm.	21⅞ in./54 cm. 16⅝ in./42.2 cm. 28½ in./72.4 cm.	21⅞ in./54 cm. 16⅝ in./42.2 cm. 28½ in./72.4 cm.	23¼ in./60.3 cm. 19⅞ in./49.2 cm. 39⅞ in./99.4 cm.	23¼ in./60.3 cm. 19⅞ in./49.2 cm. 39⅞ in./99.4 cm.
396 lbs. 180 kg.	396 lbs. 180 kg.	396 lbs. 180 kg.	220 lbs. 100 kg.	220 lbs. 100 kg.
30 gal. 114 L	30 gal. 114 L	30 gal. 114 L	55 gal. 212 L	55 gal. 212 L
16 gal. 60.6 L	16 gal. 60.6 L	16 gal. 60.6 L	30 gal. 113.6 L	30 gal. 113.6 L
18 lbs. 7.2 kg.	18 lbs. 7.2 kg.	18 lbs. 7.2 kg.	23.5 lbs. 10.7 kg.	23.5 lbs. 10.7 kg.
40	40	40	36	36
1,000	1,000	1,000	864	864
1H2/X120/S 1H2/Y180/S	1H2/X120/S 1H2/Y180/S	1H2/X120/S 1H2/Y180/S	1H2/X65/S 1H2/Y100/S	1H2/X65/S 1H2/Y100/S

Lid Styles:

- Lids feature closed cell foam or silicone gaskets
- Lid closure instructions included in each drum
- Salvage Drums pass 3-PSI pressure test

**BOLT BAND W/
REGULAR LID**
AVAILABLE IN
12 & 16 GAUGE

BUNG LID
2 BUNG HOLES:
ONE 2 IN. AND ONE ¾ IN. NTP

SCREW TOP

**PLASTIC
LEVER-LOCK**

**METAL
LEVER-LOCK**

**METAL
BAND W/BOLT**



POLY DRUMS

55 GALLON DRUMS

BUNG LID / BOLT RING OPTIONS Available for 55 Gallon Eagle Models

NEW! NATURAL COLORS Available for All Banded Drums



HDPE

100% Recyclable



Model Numbers <small>Bung Lid Models</small>	1655M 1655M-BG	1655MB 1655MB-BG	1655MBLK 1655MBLK-BG	1655MN 1655MN-BG
Style	Lab Pack Open Head Drum	Lab Pack Open Head Drum	Lab Pack Open Head Drum	Lab Pack Open Head Drum
Closure Type	Metal Lever-Lock	Metal Lever-Lock	Metal Lever-Lock	Metal Lever-Lock
Inside Dimensions <small>Top: Bottom: Height:</small>	22 $\frac{1}{8}$ in./58.1 cm. 19 in./48.3 cm. 38 $\frac{1}{8}$ in./98 cm.	22 $\frac{1}{8}$ in./58.1 cm. 19 in./48.3 cm. 38 $\frac{1}{8}$ in./98 cm.	22 $\frac{1}{8}$ in./58.1 cm. 19 in./48.3 cm. 38 $\frac{1}{8}$ in./98 cm.	22 $\frac{1}{8}$ in./58.1 cm. 19 in./48.3 cm. 38 $\frac{1}{8}$ in./98 cm.
Outside Dimensions <small>Top: Bottom: Height:</small>	23 $\frac{3}{4}$ in./60.3 cm. 19 $\frac{3}{8}$ in./49.2 cm. 39 $\frac{1}{8}$ in./99.4 cm.	23 $\frac{3}{4}$ in./60.3 cm. 19 $\frac{3}{8}$ in./49.2 cm. 39 $\frac{1}{8}$ in./99.4 cm.	23 $\frac{3}{4}$ in./60.3 cm. 19 $\frac{3}{8}$ in./49.2 cm. 39 $\frac{1}{8}$ in./99.4 cm.	23 $\frac{3}{4}$ in./60.3 cm. 19 $\frac{3}{8}$ in./49.2 cm. 39 $\frac{1}{8}$ in./99.4 cm.
Maximum Capacity	551 lbs. 250 kg.	551 lbs. 250 kg.	551 lbs. 250 kg.	551 lbs. 250 kg.
Total Capacity	55 gal. 212 L	55 gal. 212 L	55 gal. 212 L	55 gal. 212 L
Maximum Container Size <small>(If used as an overpack drum)</small>	30 gal. 113.6 L	30 gal. 113.6 L	30 gal. 113.6 L	30 gal. 113.6 L
Weight	23.5 lbs. 10.7 kg.	23.5 lbs. 10.7 kg.	23.5 lbs. 10.7 kg.	23.5 lbs. 10.7 kg.
Pallet Quantity	36	36	36	36
Truckload Quantity	864	864	864	864
UN/DOT Rating	1H2/X200/S 1H2/Y250/S	1H2/X200/S 1H2/Y250/S	1H2/X200/S 1H2/Y250/S	1H2/X200/S 1H2/Y250/S





Did you know?

Eagle HDPE poly drums with screw tops or plastic lever-lock lid closures can be incinerated completely.

Lab Packs/Open Head

- for use with smaller non-damaged bottles, cans, carboys and 5-gallon (18.9 L) pails of non-leaking hazardous materials – if leaking, must pack with sufficient sorbents – NO FREE LIQUIDS.



				
1656	1656BLK 1656BLK-BG	1656M 1656M-BG2	1656MB 1656MB-BG2	1656MBLK 1656MBLK-BG or 1656MBLK-BG2
Lab Pack Open Head Drum	Lab Pack Open Head Drum	Lab Pack Salvage Drum	Lab Pack	Lab Pack
Plastic Lever-Lock	Plastic Lever-Lock	Metal Lever-Lock	Metal Lever-Lock	Metal Lever-Lock
20 ¹ / ₁₆ in./51.2 cm. 22 ¹ / ₈ in./56.2 cm. 35 ¹³ / ₁₆ in./91 cm.	20 ¹ / ₁₆ in./51.2 cm. 22 ¹ / ₈ in./56.2 cm. 35 ¹³ / ₁₆ in./91 cm.	20 ¹ / ₁₆ in./51.2 cm. 22 ¹ / ₈ in./56.2 cm. 35 ¹³ / ₁₆ in./91 cm.	20 ¹ / ₁₆ in./51.2 cm. 22 ¹ / ₈ in./56.2 cm. 35 ¹³ / ₁₆ in./91 cm.	20 ¹ / ₁₆ in./51.2 cm. 22 ¹ / ₈ in./56.2 cm. 35 ¹³ / ₁₆ in./91 cm.
21 in./55.3 cm. 22 ¹ / ₂ in./57.2 cm. 36 ³ / ₈ in./92.4 cm.	21 in./55.3 cm. 22 ¹ / ₂ in./57.2 cm. 36 ³ / ₈ in./92.4 cm.	21 in./55.3 cm. 22 ¹ / ₂ in./57.2 cm. 36 ³ / ₈ in./92.4 cm.	21 in./55.3 cm. 22 ¹ / ₂ in./57.2 cm. 36 ³ / ₈ in./92.4 cm.	21 in./55.3 cm. 22 ¹ / ₂ in./57.2 cm. 36 ³ / ₈ in./92.4 cm.
220 lbs. 100 kg.	220 lbs. 100 kg.	551 lbs. 250 kg.	551 lbs. 250 kg.	551 lbs. 250 kg.
55 gal. 217 L	55 gal. 217 L	55 gal. 217 L	55 gal. 217 L	55 gal. 217 L
30 gal. 113.6 L	30 gal. 113.6 L	30 gal. 113.6 L	30 gal. 113.6 L	30 gal. 113.6 L
23.5 lbs. 10.7 kg.	23.5 lbs. 10.7 kg.	23.5 lbs. 10.7 kg.	23.5 lbs. 10.7 kg.	23.5 lbs. 10.7 kg.
8	8	8	8	8
336 Not Palletized	336 Not Palletized	336 Not Palletized	336 Not Palletized	336 Not Palletized
1H2/X100/S 1H2/Y100/S	1H2/X100/S 1H2/Y100/S	1H2/X200/S 1H2/Y250/S	1H2/X200/S 1H2/Y250/S	1H2/X200/S 1H2/Y250/S

Salvage Drums - for use with damaged or leaking containers of hazardous materials or used absorbent materials contaminated with a hazardous substance. Require "Salvage Drum" labeling and must pass a 3-PSI pressure test.

Overpacks - for use with larger non-damaged containers, cans and drums of non-leaking hazardous materials – if leaking, must pack with sufficient sorbents for – NO FREE LIQUIDS.

Regulatory Compliance:
Lab Packs/Open Head: DOT 49 CFR 173.12
Overpacks: DOT 49 CFR 173.25
Salvage Drums: DOT 49 CFR 173.3

POLY DRUMS

AVAILABLE IN NATURAL
1600SLBRN



100% Recyclable



Model Numbers <small>Lid Model Numbers</small>	1650	1600SL	1657	1661
Style	Lab Pack	Lab Pack	Lab Pack	Overpack
Closure Type	Screw-on lid	Screw-on lid	Screw-on lid	Screw-on lid
Inside Dimensions <small>Top: Bottom: Height:</small>	19 $\frac{3}{8}$ in./49.3 cm. 16 $\frac{3}{4}$ in./41.6 cm. 20 in./50.8 cm.	19 $\frac{3}{8}$ in./50.5 cm. 16 $\frac{3}{4}$ in./41.3 cm. 27 in./68.6 cm.	23 $\frac{3}{8}$ in./60.7 cm. 19 in./48.3 cm. 39 $\frac{1}{4}$ in./99.7 cm.	27 $\frac{1}{8}$ in./68.9 cm. 25 $\frac{15}{16}$ in./65.9 cm. 31 $\frac{1}{4}$ in./79.4 cm.
Outside Dimensions <small>Top: Bottom: Height:</small>	20 $\frac{3}{8}$ in./51.8 cm. 16 $\frac{3}{4}$ in./42.6 cm. 20 $\frac{3}{4}$ in./52.7 cm.	22 $\frac{1}{2}$ in./57.2 cm. 16 $\frac{3}{4}$ in./42.3 cm. 28 $\frac{1}{4}$ in./71.8 cm.	26 $\frac{1}{2}$ in./67.4 cm. 19 $\frac{3}{8}$ in./49.3 cm. 40 in./101.6 cm.	31 in./78.8 cm. 26 $\frac{1}{8}$ in./67.2 cm. 33 $\frac{3}{4}$ in./85.8 cm.
Maximum Capacity	125 lbs. 57 kg.	396 lbs. 180 kg.	551 lbs. 250 kg.	660 lbs. 300 kg.
Total Capacity	20 gal. 76 L	30 gal. 114 L	55 gal. 217 L	65 gal. 247 L
Maximum Container Size <small>(If used as an overpack drum)</small>	5 gal. 18.9 L	16 gal. 60.6 L	30 gal. 113.6 L	30 gal. 113.6 L
Weight	13 lbs. 5.85 kg.	18 lbs. 6.3 kg.	28 lbs. 6.3 kg.	45 lbs. 20.25 kg.
Pallet Quantity	24	24	5	3
Truckload Quantity	528	720	332	180
UN/DOT Rating	1H2/X57/S	1H2/X120/S 1H2/Y180/S	1H2/X200/S 1H2/Y250/S	1H2/X300/S



SCREW TOP



METAL BAND W/BOLT





		
1665	1690	1695
Salvage Drum	Overpack	Salvage Drum
Metal band w/bolt	Screw-on lid	Metal band w/bolt
27 $\frac{1}{8}$ in./68.9 cm. 25 $\frac{1}{2}$ in./64.8 cm. 35 $\frac{1}{8}$ in./91.2 cm.	27 $\frac{1}{8}$ in./68.9 cm. 25 $\frac{5}{16}$ in./65 cm. 39 in./99.1 cm.	27 $\frac{1}{2}$ in./69.9 cm. 25 $\frac{1}{4}$ in./64.2 cm. 38 in./96.6 cm.
31 in./78.8 cm. 26 in./66.1 cm. 38 $\frac{1}{8}$ in./98.8 cm.	31 in./78.8 cm. 26 $\frac{1}{16}$ in./66.2 cm. 41 $\frac{1}{4}$ in./104.8 cm.	31 in./78.8 cm. 25 $\frac{3}{4}$ in./65.4 cm. 44 $\frac{1}{2}$ in./112.8 cm.
440 lbs. 200 kg.	660 lbs. 300 kg.	748 lbs. 340 kg.
65 gal. 247 L	95 gal. 361 L	95 gal. 361 L
55 gal. 208.2 L	55 gal. 208.2 L	55 gal. 208.2 L
53 lbs. 23.85 kg.	50 lbs. 22.5 kg.	58 lbs. 26.1 kg.
4	3	4
192	180	192
1H2/X200/S	1H2/X300/S	1H2/X340/S

Model 1609



UN Markings: UN 1H2/X340/S/96USA/M4990

1- Type of Container (drum), H-material of construction (plastic), 2-Removable head/X-Testing performance (X=Groups I, II, & III), 340-Max. Wt. of Container (Kg)/S-solids/96/Year of Manufacture, USA-State Authorization Mark/M - certification compliance, 4990-Testing Agency number.



MATERIAL HANDLING

Eagle Manufacturing has offered affordable protection for warehouses, plants, factories, stores and other facilities for more than 20 years. From column protection to maintenance-free post-sleeves to ramps and dockplates, Eagle has the Compliance Solutions to help keep your facility protected. Our Material Handling products are designed to meet your specific needs, and are 100 percent made in the USA.





Multiple products for Material Handling and Facility Protection:

- HDPE Bollard Post Sleeves
- Bollard Posts & Machine Guards
- Wall & Corner Protectors
- Protective Parking Stops
- Poly Guide-Post Delineators
- Safety Clearance Bars
- Decorative Post Sleeves
- Portable & Fixed Dockplates
- Column Protectors
- Lightweight Poly Curb Ramp
- Lightweight Shipping Container Ramp



MATERIAL HANDLING

GUARDS & PROTECTORS

Bollard Posts and Machine Guards

Bollard Posts add protection to your facility and prevent damage. Posts feature a durable baked-on powder coat in safety yellow to provide high visibility. Each post is made of 1/4 in. (.63 cm.) thick Schedule 40 or 1/8 in. (.32 cm.) thick Schedule 10 steel mounted on 3/8 in. (.95 cm.) steel plates, pre-drilled (3/4 in./1.9 cm.) for easy installation. The black HDPE post caps are included and can be removed to fill posts with concrete for extra protection.

Machine Guards

Our machine guards provide superior protection for facilities and equipment by creating barriers between traffic areas and your valuable machinery.

Model 1754 5" (12.7 cm.) square 42" (106.7 cm.) x 5" (12.7 cm.)

Model 1764 6" (15.2 cm.) round 42" (106.7 cm.) x 6 5/8" (16.8 cm.)

Model 1747 4" (10.2 cm.) machine guard 42" (106.7 cm.) x 48" (121.9 cm.)

Model 1770 4" (10.2 cm.) machine guard 24" (70 cm.) x 48" (121.9 cm.)

Model 1765 4" (10.2 cm.) rack guard 9" (22.9 cm.) x 36" (91.4 cm.)

Model 1744 4" round 42" (106.7 cm.) x 4 1/2" (11.4 cm.)

Bollard Posts - Schedule 40 and Schedule 10					
Model	Description	Sched.	Dimensions (ht x dia)	Plate Size	Weight
1742	4" Round Bollard Post	40	in: 24 x 4 1/2 cm: 61 x 11.5	in: 8 x 8 x 3/8 cm: 20.4 x 20.4 x 1	35 lbs./15.9 kg.
1742-10	4" Round Bollard	10	in: 24 x 4 1/2 cm: 61 x 11.5	in: 8 x 8 x 3/8 cm: 20.4 x 20.4 x 1	22 lbs./10 kg.
1743	4" Round Bollard Post	40	in: 36 x 4 1/2 cm: 91.5 x 11.5	in: 8 x 8 x 3/8 cm: 20.4 x 20.4 x 1	45 lbs./20.5 kg.
1743-10	4" Round Bollard	10	in: 36 x 4 1/2 cm: 91.5 x 11.5	in: 8 x 8 x 3/8 cm: 20.4 x 20.4 x 1	28 lbs./12.7 kg.
1744	4" Round Bollard Post	40	in: 42 x 4 1/2 cm: 106.7 x 11.4	in: 8 x 8 x 3/8 cm: 20.4 x 20.4 x 1	50 lbs./22.7 kg.
1744-10	4" Round Bollard	10	in: 42 x 4 1/2 cm: 106.7 x 11.5	in: 8 x 8 x 3/8 cm: 20.4 x 20.4 x 1	30 lbs./13.6 kg.
1749	4" Round Post Cap	40	Dia: in: 5 cm: 12.7	NA	2 lbs./1 kg.
1755	5" Round Bollard Post	40	in: 24 x 5 1/2 cm: 61 x 14.3	in: 10 x 10 x 3/8 cm: 25.4 x 25.4 x 1	45 lbs./20.5 kg.
1756	5" Round Bollard Post	40	in: 36 x 5 1/2 cm: 91.5 x 14.3	in: 10 x 10 x 3/8 cm: 25.4 x 25.4 x 1	60 lbs./27.3 kg.
1757	5" Round Bollard Post	40	in: 42 x 5 1/2 cm: 106.7 x 14.3	in: 10 x 10 x 3/8 cm: 25.4 x 25.4 x 1	67 lbs./30.4 kg.
1758	5" Round Post Cap	40	Dia: in: 5 1/2 cm: 12.7	NA	2 lbs./1 kg.
1752	5" Square Bollard Post	40	in: 24 x 5 cm: 61 x 12.7	in: 10 x 10 x 3/8 cm: 25.4 x 25.4 x 1	35 lbs./15.9 kg.
1753	5" Square Bollard Post	40	in: 36 x 5 cm: 91.5 x 12.7	in: 10 x 10 x 3/8 cm: 25.4 x 25.4 x 1	47 lbs./21.4 kg.
1754	5" Square Bollard Post	40	in: 42 x 5 cm: 106.7 x 12.7	in: 10 x 10 x 3/8 cm: 25.4 x 25.4 x 1	53 lbs./24.1 kg.
1759	5" Square Post Cap	40	Square: in: 5 1/4 cm: 13.4	NA	2 lbs./1 kg.
1763	6" Round Bollard Post	40	in: 36 x 6 5/8 cm: 91.5 x 16.9	in: 10 x 10 x 3/8 cm: 25.4 x 25.4 x 1	65 lbs./29.5 kg.
1763-10	6" Round Bollard	10	in: 36 x 6 5/8 cm: 91.5 x 16.9	in: 10 x 10 x 3/8 cm: 25.4 x 25.4 x 1	40 lbs./18.2 kg.
1764	6" Round Bollard Post	40	in: 42 x 6 5/8 cm: 106.7 x 16.8	in: 10 x 10 x 3/8 cm: 25.4 x 25.4 x 1	72 lbs./32.7 kg.
1764-10	6" Round Bollard	10	in: 42 x 6 5/8 cm: 106.7 x 16.9	in: 10 x 10 x 3/8 cm: 25.4 x 25.4 x 1	44 lbs./20 kg.
1769	6" Round Post Cap	40	Dia: in: 7 cm: 17.8	NA	2 lbs./1 kg.

Machine Guards				
Model	Item	Dimensions (h x w)	Plate Size	Weight
1765	4" Low Profile Rack Guard	in: 9 x 36 cm: 22.9 x 91.4	in: 8 x 8 x 3/8 cm: 20.4 x 20.4 x 1	52 lbs./23.6 kg.
1745	4" Low Profile Rack Guard	in: 12 x 48 cm: 30.5 x 122	in: 8 x 8 x 3/8 cm: 20.4 x 20.4 x 1	62 lbs./28.2 kg.
1772	4" Rack Guard	in: 16 x 36 cm: 40.7 x 91.5	in: 8 x 8 x 3/8 cm: 20.4 x 20.4 x 1	72 lbs./32.7 kg.
1773	4" Rack Guard	in: 16 x 48 cm: 40.7 x 122	in: 8 x 8 x 3/8 cm: 20.4 x 20.4 x 1	82 lbs./37.2 kg.
1746	4" Machine Guard (Low)	in: 24 x 36 cm: 61 x 91.5	in: 8 x 8 x 3/8 cm: 20.4 x 20.4 x 1	82 lbs./37.2 kg.
1770	4" Machine Guard (Low)	in: 24 x 48 cm: 61 x 122	in: 8 x 8 x 3/8 cm: 20.4 x 20.4 x 1	92 lbs./41.8 kg.
1774	4" Machine Guard	in: 36 x 36 cm: 91.5 x 91.5	in: 8 x 8 x 3/8 cm: 20.4 x 20.4 x 1	100 lbs./45.4 kg.
1775	4" Machine Guard	in: 36 x 48 cm: 91.5 x 122	in: 8 x 8 x 3/8 cm: 20.4 x 20.4 x 1	110 lbs./49.9 kg.
1771	4" Machine Guard (High)	in: 42 x 36 cm: 106.7 x 91.5	in: 8 x 8 x 3/8 cm: 20.4 x 20.4 x 1	110 lbs./49.9 kg.
1747	4" Machine Guard (High)	in: 42 x 48 cm: 106.7 x 122	in: 8 x 8 x 3/8 cm: 20.4 x 20.4 x 1	112 lbs./50.8 kg.

Wall Protectors and Corner Protectors



Wall Protectors

Our wall protectors help prevent damage to walls in areas with forklift, hand truck or drum traffic. These guards are made of high-visibility yellow, high-density polyethylene; never need painting; and resist cracking and chipping. Can be mounted end to end, and feature unique energy absorbing construction. (Set of two) (Anchors not included)

Corner Protectors

HDPE Corner Protectors deflect the impact, helping to protect plant areas prone to damage by fork truck, hand truck or personnel traffic. Provide easy installation with bolts or optional straps (not provided). Two sizes to meet most needs sold in sets of two, inside measurement 4 in. (10.2 cm.) x 8 in. (20.3 cm.) and outside measurement 6 in. (15.2 cm.) x 10 in. (25.4 cm.).

Model 1726 6 in. (15 cm.) Wall Protector 6 in. x 42 in. x 2 in. (15 cm. x 106.7 cm. x 5.1 cm.) (each) (Sold as set of two) (Anchors not included)

Model 1725 42 in. (106.7 cm.) Corner Protector 42 in. x 6 in. x 10 in. (106.7 cm. x 15.2 cm. x 25.4 cm.) (each) (Sold as set of two) IM 4 in. (10.2 cm.) x 8 in. (20.3 cm.) OM 6 in. (15.2 cm.) x 10 in. (25.4 cm.)



Wall Protectors			
Model	Item	Dimensions (w x l x d)	Weight per set
1726	6" Wall Protector (set of two)	in: 6 x 42 x 2 cm: 15.3 x 106.7 x 5.1 each	8 lbs./3.7 kg.
1728	10" Wall Protector (set of two)	in: 10 x 42 x 2 cm: 25.4 x 106.7 x 5.1 each	14 lbs./6.4 kg.

Corner Protectors			
Model	Item	Dimensions (w x l x d)	Weight per set
1720	21" Corner Protector (set of two)	in: 21 x 6 x 10 cm: 53.3 x 15.2 x 25.4 each	10 lbs./4.6 kg.
1725	42" Corner Protector (set of two)	in: 42 x 6 x 10 cm: 106.7 x 15.2 x 25.4 each	20 lbs./9.1 kg.



100% Recyclable



Column Protectors

Affordable protection for warehouse and factory columns, posts and beams. Absorbs impact from tow motors, minimizing column, fork truck, and personnel damage and injury. These blow-molded 100 percent high-density polyethylene protectors are resistant to most chemicals and feature key-lock to prevent slippage and assist with installation alignment. Available to fit 4 in. (10.2 cm.), 6 in. (15.2 cm.), 8 in. (20.3 cm.), 10 in. (25.4 cm.) and 12 in. (30.5 cm.) round or square supports. No tools required. Two halves attach with easy-to-install straps. Protectors come in yellow with black straps, and orange or lime green with high-visibility reflective straps. (Tested with fork truck: 8,500 lbs. (3855.5 kg.) at 5 mph (8 kph). Replace if damaged.)



Model 1724-12 RED 12 in. (30.5 cm.)
Column Protector / 24 in. x 24 in. x 24 in. (61 cm. x 61 cm. x 61 cm.)



Model 1709

The 1709 model was designed to fit 9 in. (22.9 cm.) round columns and is available in yellow with black straps, and orange or lime green with high-visibility reflective straps.

Narrow Column Protector



Model 1704

4-6 in.
(10.2-15.2 cm.)
Column V-Profile

Hi-Vis Column Protectors



Model 1712 **Model 1712OR** **Model 1712LM**



100% Recyclable



Mini Column Protectors

Eagle's 'Mini' Column Protectors (Model 1724) are perfect for affordable warehouse and factory protection under fire extinguishers, and absorb impact from tow motors, minimizing column and fork truck damage. These blow-molded, 100 percent high-density polyethylene protectors feature key-locks to prevent slippage and assist installation alignment. Two halves attach with easy-to-use straps with no tools required.

These models are designed to fit 6 in. (15.2 cm.), 8 in. (20.3 cm.), 10 in. (25.4 cm.) and 12 in. (30.5 cm.) round or square supports and are available in yellow or red. (Replace if damaged)



Model 1724-10

Replacement Velcro Straps		
Model	Item	
1701	92"/233.7 cm.	Nylon Replacement Strap
1701-Ref	92"/233.7 cm.	Reflective Nylon Replacement Strap

Model 1712	Model 1710	Model 1709	Model 1708	Model 1706
12" (30.5 cm.) Column	10" (25.4 cm.) Column	9" (22.9 cm.) Column	8" (20.3 cm.) Column	6" (15.2 cm.) Column

Rack Guard

The NEW Eagle Rack Guard is designed to help prevent rack and shelving damage from forklifts and pallet trucks. With a quick and easy snap on design, these models require no tools to install and can be stacked for a desired height to comply with the international standard of 16" (40.6 cm.). The rack guard's narrow profile minimizes interference with valuable storage space.



Rack Guard			
Model	Dimensions	Fits Racking	Weight
1702	in: 6 x 5 x 8 cm: 15.3 x 12.7 x 20.4	in: 1.5 x 3 cm: 3.8 x 7.6	2 lbs./0.9 kg.
1703	in: 6 x 5 x 8 cm: 15.3 x 12.7 x 20.4	in: 3 x 3 cm: 7.6 x 7.6	2 lbs./0.9 kg.

Yellow Column Protectors			
Model	Item	Dimensions	Weight
1704	Column Protector for 4-6" Column	in: 13 x 13 x 42 cm: 33.1 x 33.1 x 106.7	16 lbs./7.6 kg.
1706	Column Protector for 6" Column	in: 24 x 24 x 42 cm: 61 x 61 x 106.7	40 lbs./18.2 kg.
1708	Column Protector for 8" Column	in: 24 x 24 x 42 cm: 61 x 61 x 106.7	40 lbs./18.2 kg.
1709	Column Protector for 9" Column	in: 24 x 24 x 42 cm: 61 x 61 x 106.7	40 lbs./18.2 kg.
1710	Column Protector for 10" Column	in: 24 x 24 x 42 cm: 61 x 61 x 106.7	40 lbs./18.2 kg.
1712	Column Protector for 12" Column	in: 24 x 24 x 42 cm: 61 x 61 x 106.7	40 lbs./18.2 kg.

Hi-Vis Column Protectors			
Model	Item	Dimensions	Weight
1706LM	Column Protector for 6" Column-Lime w/Reflective	in: 24x24x42 cm: 61x61x106.7	40 lbs./18.2 kg.
1708OR	Column Protector for 8" Column-Orange w/Reflective	in: 24x24x42 cm: 61x61x106.7	40 lbs./18.2 kg.
1708OR	Column Protector for 8" Column-Orange w/Reflective	in: 24x24x42 cm: 61x61x106.7	40 lbs./18.2 kg.
1709LM	Column Protector for 9" Column-Lime w/Reflective	in: 24x24x42 cm: 61x61x106.7	40 lbs./18.2 kg.
1709OR	Column Protector for 9" Column-Orange w/Reflective	in: 24x24x42 cm: 61x61x106.7	40 lbs./18.2 kg.
1710LM	Column Protector for 10" Column-Lime w/Reflective	in: 24x24x42 cm: 61x61x106.7	40 lbs./18.2 kg.
1710OR	Column Protector for 10" Column-Orange w/Reflective	in: 24x24x42 cm: 61x61x106.7	40 lbs./18.2 kg.
1712LM	Column Protector for 12" Column-Lime w/Reflective	in: 24x24x42 cm: 61x61x106.7	40 lbs./18.2 kg.
1712OR	Column Protector for 12" Column-Orange w/Reflective	in: 24x24x42 cm: 61x61x106.7	40 lbs./18.2 kg.

Mini Column Protectors			
Model	Item	Dimensions	Weight
1724-6	Column Protector for 6" Column, Yellow	in: 24 x 24 x 24 cm: 61 x 61 x 61	30 lbs./13.6 kg.
1724-6 RED	Column Protector for 6" Column, Red	in: 24 x 24 x 24 cm: 61 x 61 x 61	30 lbs./13.6 kg.
1724-8	Column Protector for 8" Column, Yellow	in: 24 x 24 x 24 cm: 61 x 61 x 61	30 lbs./13.6 kg.
1724-8 RED	Column Protector for 8" Column, Red	in: 24 x 24 x 24 cm: 61 x 61 x 61	30 lbs./13.6 kg.
1724-10	Column Protector for 10" Column, Yellow	in: 24 x 24 x 24 cm: 61 x 61 x 61	30 lbs./13.6 kg.
1724-10 RED	Column Protector for 10" Column, Red	in: 24 x 24 x 24 cm: 61 x 61 x 61	30 lbs./13.6 kg.
1724-12	Column Protector for 12" Column, Yellow	in: 24 x 24 x 24 cm: 61 x 61 x 61	30 lbs./13.6 kg.
1724-12 RED	Column Protector for 12" Column, Red	in: 24 x 24 x 24 cm: 61 x 61 x 61	30 lbs./13.6 kg.

MATERIAL HANDLING

GUARDS & PROTECTORS

Eagle offers the widest selection of HDPE Bollard Post Sleeves available

Eagle's HDPE Bollard Post Sleeves make old bollards look like new. High Density Polyethylene (HDPE) construction with UV inhibitors resist fading, rusting and cracking. The post sleeves are designed to easily fit over 4 in. (10.2 cm.), 6 in. (15.2 cm.) and 8 in. (20.3 cm.) NPT pipe and eliminate the need for annual maintenance, while helping to protect vehicles and the post from impact damage. The unique design allows for easy slide-on installation.

Benefits of all Eagle HDPE Post Sleeves:

- Improves property appearance at minimal cost
- Saves on annual painting and scraping of old bollards
- Slides over existing posts for easy installation
- High-quality, all-weather HDPE – will not rust or dent
- Fade resistant with UV inhibitors
- Colors to match many exteriors
- Sleeve height may be easily trimmed for an exact fit
- HDPE thickness



Model 1738-72 8" x 72" (20.3 cm. x 182.9 cm.) **Yellow only**

Model 1730-72 6" x 72" (15.2 cm x 182.9 cm.)

Model 1738 8" x 57" (20.3 cm. x 144.8 cm.)

Model 1730 6" x 56" (15.2 cm. x 142.3 cm.)

Model 1732 4" x 56" (10.2 cm. x 142.3 cm.)



Original HDPE Bumper Post Sleeves

The Original HDPE Bumper Post Sleeves have a vertical fluted design to provide extra protection and easier installation. They come 56 in. (142.24 cm.) in length (to fit 4 in./10.2 cm., 6 in./15.2 cm. and 8 in./20.3 cm. pipe) and are available in yellow, red, blue, white, green, orange, lime, brown and black. The 72 in. (182.9 cm.) length Bumper Post Sleeves (to fit 6 in./15.2 cm. and 8 in./20.3 cm. pipe) are available in yellow only. Sleeve height may be easily trimmed for an exact fit.



Model 1730BR 6" (15.2 cm.) (Brown) Bollard Post Sleeve

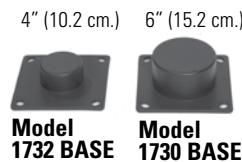

Poly Base

Poly bases available for 4" (10.2 cm.) and 6" (15.2 cm.) post sleeves to convert into poly bollard.

Bumper Post Sleeves													
Size	I.D.	O.D.	Height	Red	White	Yellow	Green	Orange	Lime	Brown	Black	Blue	Weight
4"	in: 4 ¹ / ₄ cm: 12.1	in: 5 ¹ / ₄ cm: 14.6	in: 56 cm: 142.3	1732R	1732W	1732	1732GN	1732OR	1732LM	1732BR	1732BLK	1732BL	5 lbs./2.3 kg.
6"	in: 6 ¹ / ₈ cm: 17.5	in: 7 ¹ / ₈ cm: 20	in: 56 cm: 142.3	1730R	1730W	1730	1730GN	1730OR	1730LM	1730BR	1730BLK	1730BL	8 lbs./3.7 kg.
8"	in: 8 ¹ / ₈ cm: 22.5	in: 10 cm: 25.4	in: 57 cm: 144.8	1738R	1738W	1738	1738GN	1738OR	1738LM	1738BR	1738BLK	1738BL	9 lbs./4.1 kg.
6"	in: 6 ¹ / ₈ cm: 17.5	in: 7 ¹ / ₈ cm: 20	in: 72 cm: 182.9	-	-	1730-72	-	-	-	-	-	-	11 lbs./5 kg.
8"	in: 8 ¹ / ₈ cm: 22.5	in: 10 cm: 25.4	in: 72 cm: 182.9	-	-	1738-72	-	-	-	-	-	-	15 lbs./6.8 kg.



100% Recyclable



TESTED TOUGH

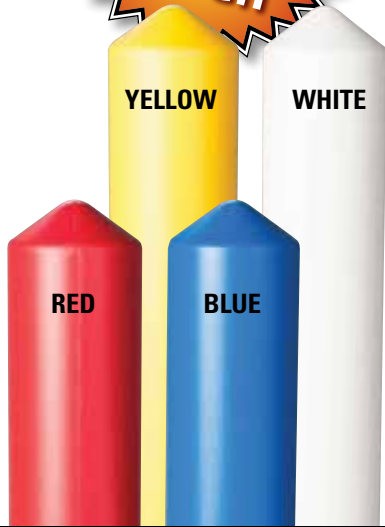

HDPE Smooth Bollard Post Sleeves

Eagle's Smooth Bollard Post Sleeves are available to fit over 4" (10.2 cm.), 6 in. (15.2 cm.) and 8 in. (20.3 cm.) pipe and are available in red, yellow, blue and white (available in other colors for quantity orders). The smooth sleeves are 56 in. (142.2 cm.) in length and provide the same maintenance-free protection as the original bumper post sleeves. Sleeve height may be easily trimmed for an exact fit.

Smooth Post Sleeves								
Size	I.D.	O.D.	Height	Red	Yellow	Blue	White	Weight
4"	in: 4 3/4 cm: 12.1	in: 5 1/4 cm: 13.4	in: 56 cm: 142.3	1735R	1735	1735BL	1735W	4 lbs./1.8 kg.
6"	in: 6 1/8 cm: 17.5	in: 7 1/8 cm: 18.8	in: 56 cm: 142.3	1736R	1736	1736BL	1736W	6 lbs./2.8 kg.
8"	in: 8 1/8 cm: 22.6	in: 9 3/8 cm: 23.9	in: 57 cm: 144.8	1737R	1737	-	-	8 lbs./3.7 kg.



Model 1736 - 6 in. (15.2 cm.) Smooth Post Sleeve 6.875 in. x 56 in. (142.3 cm.)

NEW!



HDPE Smooth Bollard Post Sleeves with Reflective Stripes

New to the Eagle Bollard Post Sleeve family are the HDPE Smooth Bollard Post Sleeves with reflective stripes. Keep your facility safe and protected with sleeves to fit over 4 in. (10.2 cm.), 6 in. (15.2 cm.) and 8 in. (20.3 cm.) pipe in HDPE yellow with two red stripes, or red with two white stripes. Sleeve height may be easily trimmed for an exact fit.

Smooth Post Sleeves with Reflective Stripes						
Size	I.D.	O.D.	Height	Red	Yellow	Weight
4"	in: 4 3/4 cm: 12.1	in: 5 1/4 cm: 13.4	in: 56 cm: 142.3	1735RWS	1735YRS	4 lbs./1.8 kg.
6"	in: 6 1/8 cm: 17.5	in: 7 1/8 cm: 18.8	in: 56 cm: 142.3	1736RWS	1736YRS	6 lbs./2.8 kg.
8"	in: 8 1/8 cm: 22.6	in: 9 3/8 cm: 23.9	in: 57 cm: 144.8	1737RWS	1737YRS	8 lbs./3.7 kg.

Decorative Post Sleeves

Beautiful HDPE post sleeves slip over 4 in. (10.2 cm.) x 4 in. (10.2 cm.) wooden or steel posts or can be used free standing with optional rubber base. Available in three styles. Includes 6 in. (15.2 cm.) of poly chain.



Golf Traditions Hitching Post Classic
Golf Traditions also available in white for use as 150-yd. marker.

ArmorKraft™ Decorative Post Sleeve			
Model	Description	Dimensions (base dia. x h.)	Weight
1713BLK	Classic	in: 12 1/2 x 37 cm: 31.8 x 94	10 lbs./4.5 kg.
1714BLK/1714WHT	Golf Traditions	in: 12 1/2 x 37 cm: 31.8 x 94	10 lbs./4.5 kg.
1715BLK	Hitching Post	in: 12 1/2 x 43 cm: 31.8 x 109.2	10 lbs./4.5 kg.
1719BLK/1719WHT	Replacement Chain Kit	6 in./15.2 cm. long	1 lb./0.5 kg.
1718BASE	Rubber Base Kit	in: 12 x 4 cm: 30.5 x 10.2	10 lbs./4.5 kg.

Eagle e-CART Industrial Waste Cart

Model 1696BLK
65 Gallon (246 L)



Features:

- Constructed of durable HDPE
- Ergonomically designed handles
- HDPE wheels on a heavy duty steel axle
- Double-walled hinged lid with a hold-down tab
- Rugged galvanized steel bar handles
- Wear tabs on the bottom

NEW!

Eagle e-CART Wheeled Industrial Waste Container

Model	Description	Capacity	Color	Weight
1696BLK	Eagle e-CART Wheeled Industrial Waste Container	65 gal./246 L	Black	32 lbs./14.5 kg.
1696GN	Eagle e-CART Wheeled Industrial Waste Container	65 gal./246 L	Green	32 lbs./14.5 kg.
1697BLK	Eagle e-CART Wheeled Industrial Waste Container	95 gal./359.6 L	Black	38 lbs./17.2 kg.
1697GN	Eagle e-CART Wheeled Industrial Waste Container	95 gal./359.6 L	Green	38 lbs./17.2 kg.

Model 1696GN
65 Gallon (246.1 L)



Model 1697BLK
95 Gallon (359.6 L)

MATERIAL HANDLING

TRAFFIC SAFETY PRODUCTS

Protective Parking Stops & Speed Bump-Cable Protectors



Eagle Parking Stops, designed with safety and durability in mind, eliminate the need for seasonal painting. Flexible enough to fit parking lot contours – the rugged HDPE Stops are weather and chemical resistant. Eagle offers four colors – the high-visibility yellow, blue for handicapped areas, gray and black. Anchor kit with three spikes and tube of asphalt adhesive included.

Eagle Speed Bump-Cable Protectors add safety to your facility. The high-visibility yellow bumps are engineered at the perfect angle. They also act as a dual channel cable protector, feature a non-skid surface, and are weather and chemical resistant. HDPE construction means you eliminate the need to continually paint bumps. The 6 ft. (22.7 cm.) anchor kit includes six spikes and a tube of asphalt adhesive. The 9 ft. (34.1 cm.) anchor kit includes eight spikes and a tube of asphalt adhesive.

Load Tested to 10,000 lbs./4535 kg. per Pneumatic Tire



Model 1790Y Parking Stop - Yellow
in: 8W x 4H x 72L/cm: 20.3W x 10.2H x 182.9L



Model 1792 6 ft. Speed Bump - Cable Guard/in: 10W x 2H x 72L
cm: 25.4W x 5.1H x 182.9L

Inside Channel Dimensions:
in: 1.25W x 0.875H/cm: 3.2W x 2.2H

Protective Parking Stops			
Model	Description	Dimensions (w x h x l)	Weight
1790Y	Parking Stop-Yellow	in: 8 x 4 x 72 cm: 20.3 x 10.2 x 182.9	15 lbs./6.8 kg.
1790B	Parking Stop-Blue	in: 8 x 4 x 72 cm: 20.3 x 10.2 x 182.9	15 lbs./6.8 kg.
1790G	Parking Stop-Gray	in: 8 x 4 x 72 cm: 20.3 x 10.2 x 182.9	15 lbs./6.8 kg.
1790BLK	Parking Stop-Black	in: 8 x 4 x 72 cm: 20.3 x 10.2 x 182.9	15 lbs./6.8 kg.

Speed Bump-Cable Protectors				
Model	Description	Dimensions (w x l x h)	Weight	Load*
1792	6' Speed Bump-Cable Guard	in: 10 x 72 x 2 cm: 25.4 x 182.9 x 5.1	20 lbs./9.1 kg.	20,000 lbs./9,071 kg.
1793	9' Speed Bump-Cable Guard	in: 10 x 108 x 2 cm: 25.4 x 274.4 x 5.1	25 lbs./11.4 kg.	20,000 lbs./9,071 kg.

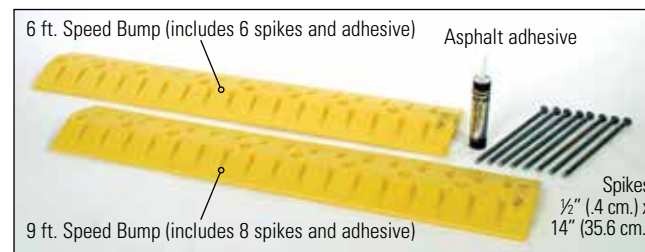

*Load Tested to 20,000 lbs./9,061 kg. per Pneumatic Tire

Model 1793 9 ft. Speed Bump - Cable Guard Kit/in: 10W x 2H x 108L
cm: 25.4W x 5.1H x 274.4L - Two 4.5 in. (11.4 cm.) Sections
*Pre-drill concrete for installation

Poly Guide-Post Delineators™ & Poly Bollard Posts

Poly Guide-Post Delineators™

Lightweight, portable, yieldable HDPE posts used to warn, guide and delineate. Feature 3 in. (11.4 cm.) – wide reflective bands for increased visibility and are MUTCD compliant. Posts are mounted on a 10 in. (37.9 cm.) sq. poly plate with anchor slots (¾ in./2.8 cm.) for permanent use or used with steel base for portable stability.

Poly Bollard Posts

Create a low-cost, maintenance-free caution zone. These 42 in. (159 cm.) – high poly bollards are available in a 5 in. (18.9 cm.) or 7 in. (26.5 cm.) model with a poly base with anchor slots (¾ in./2.8 cm.) that can be anchored for maximum stability or used with optional weighted steel base.



Poly Guide-Post Delineators

Poly Bollard Posts

Poly Guide-Post Delineators			
Model	Description	Dimensions (w x h)	Weight
1734Y	Poly Guide-Post Delineator-Yellow	in: 5.75 x 42 cm: 14.6 x 106.7	6 lbs./2.7 kg.
1734LM	Poly Guide-Post Delineator-Lime	in: 5.75 x 42 cm: 14.6 x 106.7	6 lbs./2.7 kg.
1734OR	Poly Guide-Post Delineator-Orange	in: 5.75 x 42 cm: 14.6 x 106.7	6 lbs./2.7 kg.

Poly Bollards/Posts			
Model	Description	Dimensions (w x h)	Weight
1731	5" Poly Bollard	in: 5 x 42 cm: 12.7 x 106.7	5 lbs./2.3 kg.
1733	7" Poly Bollard	in: 7 x 42 cm: 17.8 x 106.7	8 lbs./3.6 kg.
1731BASE	Steel Weighted Base for 1731, 1733 & 1734	in: 10 x 10 x 3.75 cm: 25.4 x 25.4 x 9.6	12 lbs./5.4 kg.



All-in-one Steel Bollard Post & Poly Post Sleeve Combos!

These combos bring you the security of our 1/4" (.9 cm.) thick steel Bollards, packaged with the protection and zero maintenance of our smooth Poly Post Sleeves. The combos are available in round 4" (15.1 cm.) and 6" (22.7 cm.) bollard/sleeves 36" (136.3 cm.) high and 42" (159 cm.) high. Each combo includes a foam installation kit for a perfect fit! Kit may be ordered separately.

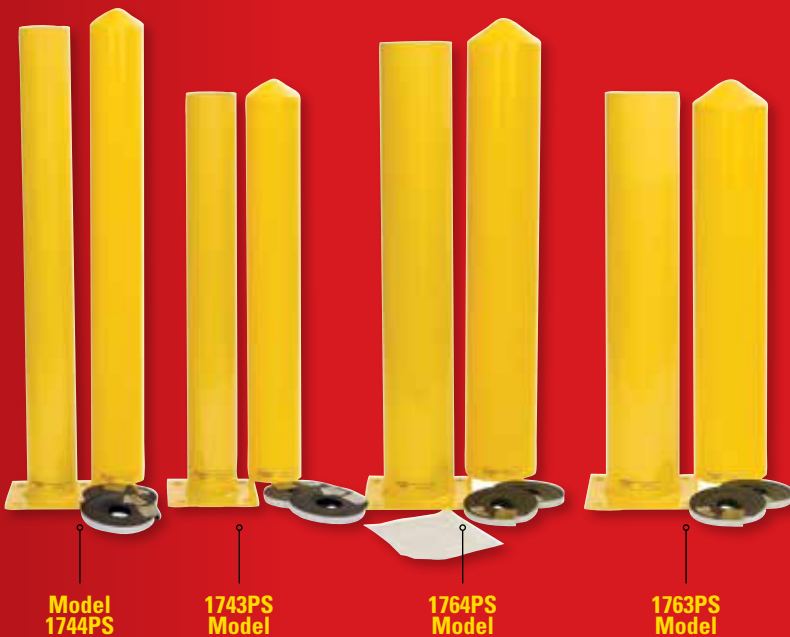

Bollard Post & Sleeve Combos					
Model	Description	Dimensions (h x dia)		Item	Weight
1743PS	4" Bollard w/Sleeve	in: 36 x 4.5/cm: 91.5 x 11.5	in: 36 x 5/cm: 91.5 x 12.7	2	50 lbs./22.7 kg.
1744PS	4" Bollard w/Sleeve	in: 42 x 4.5/cm: 106.7 x 11.5	in: 42 x 5/cm: 106.7 x 12.7	2	55 lbs./25 kg.
1763PS	6" Bollard w/Sleeve	in: 36 x 6.6/cm: 91.5 x 16.9	in: 36 x 7/cm: 91.5 x 17.8	2	70 lbs./31.8 kg.
1764PS	6" Bollard w/Sleeve	in: 42 x 6.6/cm: 106.7 x 16.9	in: 42 x 7/cm: 106.7 x 17.8	2	77 lbs./35 kg.
1739KIT	Installation Kit for Post Sleeves				



100% Recyclable

Safety Clearance Bars

Eagle introduces two safety clearance bars for use in drive-thrus, parking garages and much more. Clearance Bars provide an early warning for motorists, reducing structural and vehicle damage. This is even more necessary as SUVs and pickups have grown in size. The Clearance Bars are constructed of high-visibility yellow polyethylene and are available in 76 in. (193 cm.) and 77 in. (195.6 cm.) lengths in either 5 in. (12.7 cm.) or 7 in. (17.8 cm.) outside diameter. Both come with eyebolts for easy installation (chain not included).

Clearance Bars				
Model	Description	Dimensions (dia x l)		Weight
1780	5" Clearance Bar	in: 5 x 76	cm: 12.7 x 193.1	7 lbs./3.2 kg.
1781	7" Clearance Bar	in: 7 x 77	cm: 17.8 x 195.6	9 lbs./4.1 kg.



Model 1781 Clearance Bar / in: 7 in. dia. x 77 in. L cm: 17 x 195.6

MATERIAL HANDLING

POLY DOCKPLATES & RAMPS

MODELS
IN USE



Model Numbers	1794	1795	1797
Name	Poly Curb Ramp	Portable Poly Dockplate 35"	Portable Poly Dockplate 48"
Dimension W x L x H	in: 27 x 27 x 4 cm: 68.6 x 68.6 x 10.2	in: 35 x 36 x 5 cm: 89 x 91.5 x 12.7	in: 48 x 36 x 5 cm: 122 x 91.5 x 12.7
Weight	9 lbs./4.1 kg.	37 lbs./16.8 kg.	40 lbs./18.2 kg.
Max Load <small>Uniform Distributed Load (UDL)</small>	1,000 lbs./453.6 kg.	750 lbs./340.2 kg.	750 lbs./340.2 kg.
Height Diff.	8 in./20.3 cm.	4 in./10.2 cm.	4 in./10.2 cm.

- For use with hand trucks or wheeled carts
- Provides an ergonomically correct method to move heavy loads over curbs or up steps
- Raised surface for excellent traction in all weather conditions
- 1 in. (2.5 cm.) side rails
- Constructed of yellow HDPE
- Lightweight (9 lbs./4.1 kg.) with two handles with rounded edges for easy pickup, carrying and handling
- Ramp also used with Eagle Safety Cabinets as cabinet ramp

For Models 1795 & 1797

- For use with two- and four-wheeled dollies, hand trucks and carts
- Lightweight, ergonomic design is easy to use
- Raised surface for excellent traction in all weather conditions
- Beveled entry and exit edges
- Aluminum legs for durability and strength
- Constructed of yellow HDPE
- Two integrated handles for easy handling
- Available in 35 in. (89 cm.) and 48 in. (122 cm.) widths

Compliance: Meets OSHA 1910.30(a)





Eagle Airplane Service Ramp

Model 1791Y

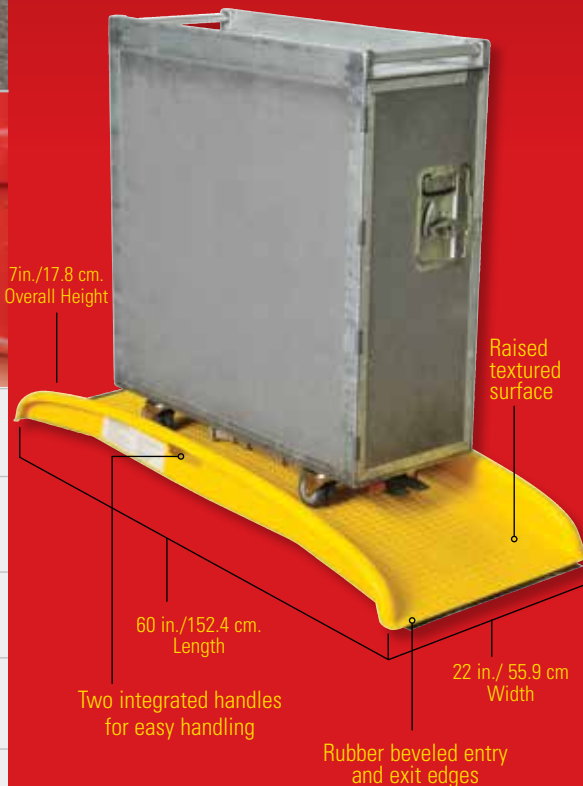

Eagle's new Airplane Service Ramp is constructed of durable, lightweight, high-density polyethylene (HDPE) for use in transferring service carts from the service vehicle into the aircraft. This ramp features a lightweight (28 lbs./12.7 kg.) ergonomic design with a raised textured surface, beveled entry and exit edges, high-visibility yellow HDPE, full-length guardrails with integrated handles for easy handling and a 1,000-lb. (453.6 kg.) load capacity (UDL). 100 percent made in the USA.

1796

Fixed Poly Dockplate

in: 35 x 26 x 5
cm: 89 x 66.1 x 12.7

20 lbs./9.1 kg.

1,000 lbs./453.6 kg.

4 in./10.2 cm.

- Lift-n-lower ergonomic design helps reduce injuries
- Features molded-in, raised surface and integrated side rails
- Coated steel installation kit installs easily on metal or concrete dock facings
- 6 in. (15.3 cm.) slide bar for easy truck centering or out-of-the-way storage



1796KIT Fixed Poly Dockplate Installation Kit (Sold separately)

1795CR

Shipping Container Ramp

in: 35 x 36 x 6
cm: 89 x 91.5 x 15.3

25 lbs./11.4 kg.

750 lbs./340.2 kg.

10 in./25.4 cm.

- For use with hand trucks and dollies for loading and unloading
- Features a hook rail that attaches to the doorkeepers for secure, three-point contact and support across the width of the ramp, as well as a tab that inserts into the keepers to help prevent lateral movement of the ramp during use



Airplane Service Ramp – Yellow

Model	Description	Weight	Dimensions (l x w x h)	Load
1791Y	Airplane Service Ramp Y	lbs: 28 kg: 11.7	in: 60 x 22 x 7 cm: 152.4 x 55.9 x 17.8	lbs: 1000 kg: 453.6
Packing Dimensions: in: 61 x 23 x 8/cm: 154.9 x 58.4 x 20.3				

EAGLE

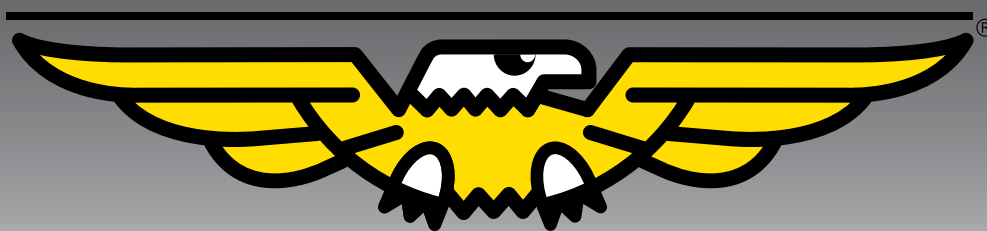

PROTECTING PEOPLE, PROPERTY AND THE PLANET®

Since 1894

eagle-mfg.com

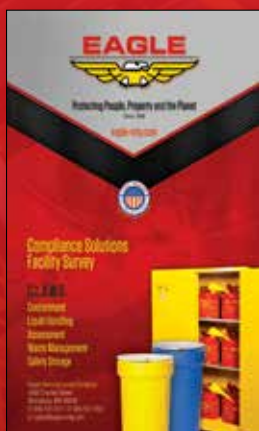

FREE!
COMPLIANCE
SOLUTIONS
GUIDE

C.L.A.W.S. is a compliance evaluation system utilized to promote employee and public safety, property protection and environmental conservation by specifying approved products that meet specific federal regulations concerning containment, liquid handling, waste management and safety storage of hazardous materials. Go to our website to request a **FREE C.L.A.W.S.** guide.

eagle-mfg.com

Eagle Manufacturing Company, a family-owned business established in 1894, is a prime manufacturer of Safety Cans, Safety Cabinets, Secondary Spill Containment, Poly Drums and Material Handling Protective Products. Eagle designs and manufactures all of its own products. Eagle is certified to the ISO-9001 Quality System and is the most respected brand name for consistent quality and value.

Eagle is the leading supplier of these products, offering a large selection of the industrial safety and material handling products for contractors, manufacturers, utilities, military, professional, government, printing, chemical, fabricators, transportation, textile mills, automotive, agricultural, medical, oil and gas, electrical and other industrial and commercial customers.

Eagle products are "Compliance Solutions" that help industry meet strict state and federal regulations concerning the handling and storage of hazardous materials.